

SLE

THREE PHASE

DC MOTOR CONTROLLER

20Q



IMPORTANT SAFETY NOTES

READ AND UNDERSTAND THIS MANUAL BEFORE
APPLYING POWER TO THE SLE MOTOR DRIVE UNIT

The SLE motor drive controller is an open chassis component for use in a suitable enclosure

Drives and process control systems are a very important part of creating better quality and value in the goods for our society, but they must be designed, installed and used with great care to ensure everyone's SAFETY.

Remember that the equipment you will be using incorporates...

High voltage electrical equipment

Powerful rotating machinery with large stored energy

Heavy components

... and your process may involve ...

Hazardous materials

Expensive equipment and facilities

Interactive components

Always use qualified personnel to design, construct and operate your systems and keep SAFETY as your primary concern.

Thorough personnel training is an important aid to SAFETY and productivity.

SAFETY awareness not only reduces the risk of accidents and injuries in your plant, but has a direct impact on improving product quality and costs.

If you have any doubts about the SAFETY of your system or process, consult an expert immediately. Do not proceed without doing so.

HEALTH AND SAFETY AT WORK

Electrical devices can constitute a safety hazard. It is the responsibility of the user to ensure the compliance of the installation with any acts or bylaws in force. Only skilled personnel should install and maintain this equipment after reading and understanding this instruction manual. If in doubt refer to the supplier



Note. The contents of this manual are believed accurate at the time of printing. The manufacturers, however, reserve the right to change the content and product specification without notice. No liability is accepted for omissions or errors. No liability is accepted for the installation or fitness for purpose or application of the SLE motor drive unit.

INSIDE FRONT COVER IMPORTANT SAFETY NOTES

1	General description	21	Stall timer
2	Specification	22	Customer presets / Layout
3	Typical applications	23	Safety diagram
4	Mechanical Dimensions	24	Fault finding chart
5	Terminal listing	25	Maintenance, spares
6	Power terminals, presets	26	Terminals 51 - 70
SET UP PROCEDURE		27	Worked example
7	Visual checklist	28	Block Diagram
8	Function switches	29	Fuse table
9	Jumpers/alarms		
10	Initial power up	30	Appendix (section 6)
11	Stop start and demand	1/2/3	Basic connections
12	Powering motor	4	Winder application
13	Running checks	5	Speed following. Load sharing
14	Stability adjustment	6	Master setpoint multi drive
15	Alarms	7	Main contactor applications
16	Field voltage / S Ramps	8	Zero reference interlock
17	Inhibit block diagram	9	Reversing
18	Setpoint ramp graphs	10	Simple dancing arm
19	Torque functions	11	Jog applications
20	Torque control	12	Field applications
		13	MICRO ANALOG PROCESSOR
		14/15	circuit diagrams
		16	component layout
		17	local transformer supplies
		18	EMC installation guidelines

GENERAL DESCRIPTION

The units employ closed loop control of both armature current and feedback voltage to give precise control of the motor torque and speed.

The motor and drive are protected by a stall timer which automatically removes power after 30 seconds if the required speed cannot be achieved. The drives will provide up to 150% of the preset maximum current for up to 30 seconds allowing high short term torques during acceleration or other changes in load. Independant control of either the current or speed loops by external inputs allows torque or speed control applications with overspeed or overcurrent protection. The demand signal may be derived from a potentiometer, 0-10V signal or 4-20mA loop. The speed feedback signal may be selected to be the ARMATURE VOLTAGE or a shaft mounted TACHOMETER.

The drive consists of 2 high accuracy feedback control loops.

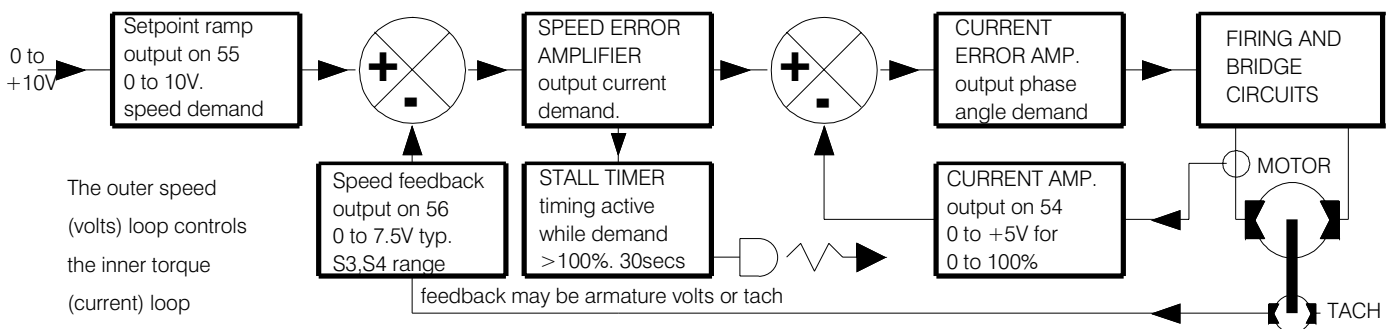

There is a comprehensive range of extra inputs and outputs and the unit has electrically isolated control circuits to allow interfacing to external sources. The units are assembled using the latest automation, and employ modern surface mount techniques. This gives superb accuracy and stability and is only made possible by the high production volumes of **SPRINT** *Electrics*

SLE SERIES 3 PHASE 2Q DC MOTOR CONTROLLER

ELECTRICAL SPECIFICATION

SUPPLY VOLTAGE	low tap	high tap	
3 phase 50-60Hz	200/240	380/480	+/- 5%
seperate in-phase supply to stack			

ARMATURE VOLTS	1.1 times AC maximum			
AC supply	240	380	415	480
AV DC max	265	420	460	530

FIELD output is multiplier of AC input
 2 phase supply 0.9 or 0.45
 3 phase supply 0.67 or 0.34 or 1.35
 The field bridge is separately excited

TEMPERATURE (class 3K3)
 0-50C ambient cubicle internal operating temp
 -25C to +55C storage (class 1K4)
 See page 4 for ventilation requirements
 UL rating is 40C maximum ambient

RELATIVE HUMIDITY (class 3K3)
 5 - 85% non-condensing

ALTITUDE (class 3K3)
 1000m (86Kpa - 106Kpa)

THYRISTOR BRIDGE
 3 Phase fully controlled

ELECTRICAL ISOLATION
 high voltage power circuits are isolated from control circuits (the COMMON terminal must be earthed for protective class 1 code compliance)

PUSHBUTTON INPUTS
 POWER ON
 POWER OFF

PRESET CONTROLS
 MAX SPEED
 MIN SPEED
 JOG SPEED
 FORWARD UP RAMP
 FORWARD DOWN RAMP
 SPEED STABILITY
 IR COMP
 MAXIMUM CURRENT

LINK OPTIONS
 50% stall level
 S shaped ramps
 4-20mA loop
 speed mode
 torque mode

PRESET SWITCHES

1 current scale	5 relay 1 stall
2 relay 1 timer	6 relay 1 zero
3 speed scale	7 ramp connect
4 speed scale	8 tac/av

CONTACT RATINGS
 1A AT 120V AC main contactor
 960VA switch slave

PERFORMANCE SPECIFICATION

TYPE	KW at 460V	HP at 460V	HP at 500V	ARMATURE max amps	FIELD max amps
SLE 14	14	19	20	34 DC	2.5
SLE 24	24	32	30	58 DC	2.5
SLE 34	34	46	50	82 DC	2.5
SLE 44	44	60	60	106 DC	2.5

TYPICAL MAXIMUM OUTPUT RATINGS

SPEED RANGE
 100:1 with tacho speed feedback
 20:1 with armature volts feedback

STEADY STATE ACCURACY
 0.1% with tacho feedback

OVERLOAD CAPACITY
 150% full load current for 30 secs.

I X t protection with contactor drop out

TORQUE LIMIT CONTROL (arm. current)
 0 to 100% of max current rating

SHORT CIRCUIT RATING
 (see fuse table page 29)
 Suitable for use on a circuit capable of delivering not more than
 5,000A (SLE14/24/34) 10,000A (SLE44)
 RMS symmetrical amperes, 480 Volts maximum.
 When protected by aR class fuses.

INDICATORS
 on auxiliary trip
 stall heatsink temperature
 timer slave contact

CONTROL MODES
 SPEED with torque limit
 TORQUE with speed limit

SIGNAL OUTPUTS	RAILS AND DRIVERS
linear isolated	
speed	+10 +12 +24-12 -24
current	
setpoint ramp	1 timer
total setpoint	2 stall
armature volts	3 zero speed
jog setpoint	4 zero reference volt free relay

SIGNAL INPUTS linear isolated

ramped speed
 aux ramped speed
 inverted ramped speed
 direct speed
 torque demand

This diagram shows a simple form of speed control wiring. Please refer to page 28 for block diagram
See application drawings at the back of the manual in section 6

For applications in the European Union special precautions may have to be taken for EMC purposes. A line filter may be required (shown as dotted box) in non-industrial installations, and EMC guidelines followed. See section 6.18.

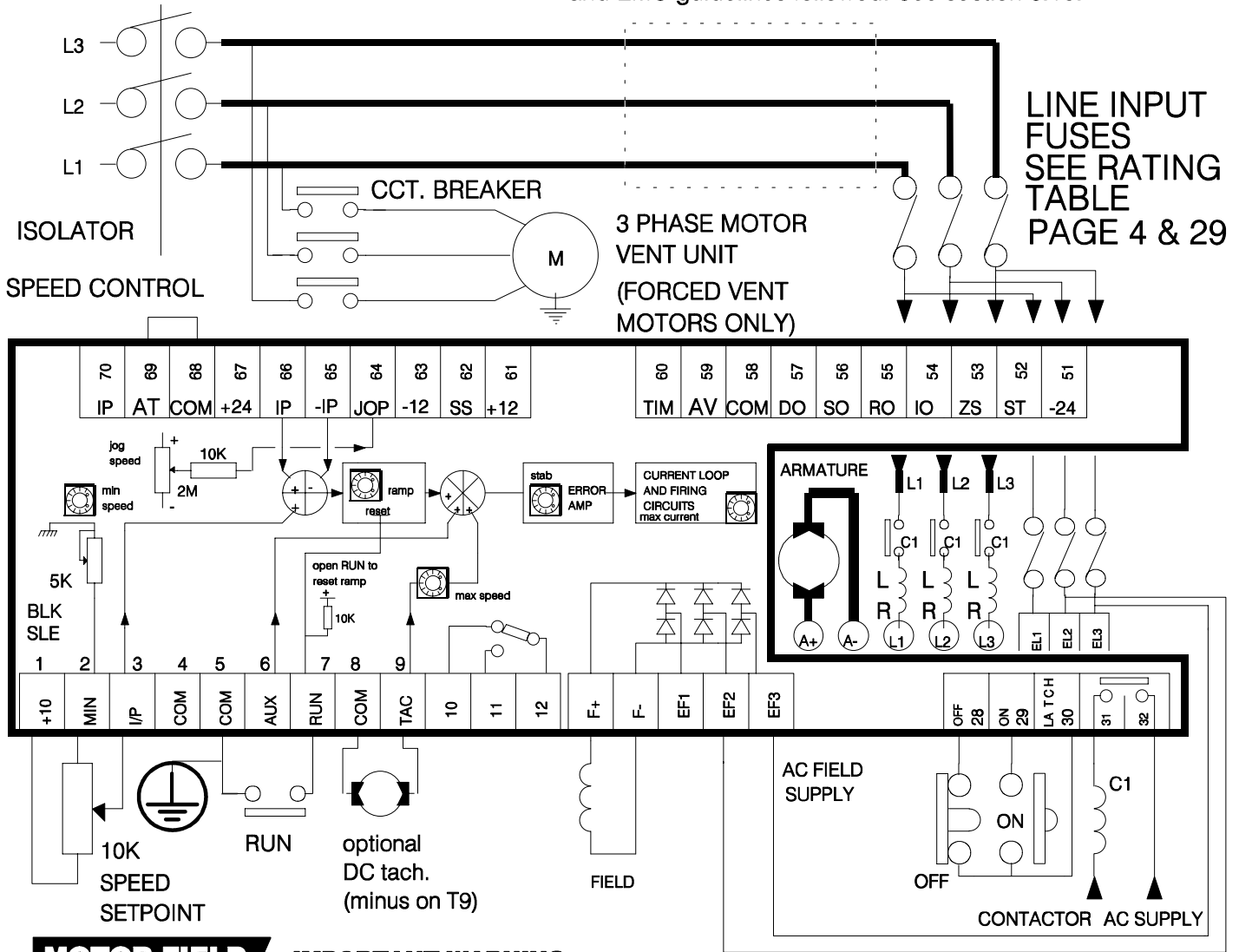

MOTOR FIELD **IMPORTANT WARNING**

This typical application shows the motor field energised permanently by the auxiliary supply. This allows dynamic braking systems to function. Precautions must be taken to prevent the field overheating while the motor is at rest. See section 6 page 12 for delayed turn off or main contactor energised field applications.

LINE REACTOR **IMPORTANT WARNING**

All thyristor 3 phase converters commute the load current between devices and lines. During the process of commutation which lasts approximately 100 microseconds, notching will appear on the incoming supply lines. To prevent possible disturbance to the supply it is necessary to use a 3 phase LINE REACTOR between the POWER connections of the drive and the supply lines. Sprint has developed a range of Line Reactors to suit all models in the SLE range. It is essential that all three phase drive systems incorporate the appropriate Line Reactor. See Rating Table page 4 and Dimensions on page 29.

FUSING AND EARTHING **IMPORTANT WARNING**



INTERNATIONAL GROUND SYMBOL (BLACK ON GREEN BACKGROUND) IDENTIFIES DRIVE EARTH TERMINAL

All incoming main power supply connections must be protected by the correct fuses (warranty requirement). A substantial earth connection must be made to the earth terminal of the drive.
SAFETY EARTHING. The isolated control common (0V) must be connected to protective earth to ensure the equipment meets protective class 1 criteria. Refer to section 6.18 for analogue signal earthing details.

POWER ON/POWER OFF **IMPORTANT WARNING**

The POWER ON/OFF control facilities (T28/29) integral to the drive must be used to energise the main contactor. This ensures correct power sequencing. The armature current may not be commutated to zero correctly, and could cause non-warranty damage if this advice is ignored. If safety codes mandate external contactor control, then the POWER OFF function on T28/29 must be initiated 100ms prior to contactor opening to avoid damage. (See application 6.7)

Four corner mounting slots are provided to mount the unit. Use M6 (1/4in) screws. A substantial earth connection should be made to the stud provided. Nominal cooling air throughput is specified in the rating table below. NOTE: Do not block the heatsink fins. Allow 50mm (2 in) space. Note: Ensure connections to power terminals are tight.

Please consider the total dissipation within the enclosure when calculating the required air throughput. This includes the fuses, line reactors and other sources of dissipation. See the appropriate pages for dissipation ratings.

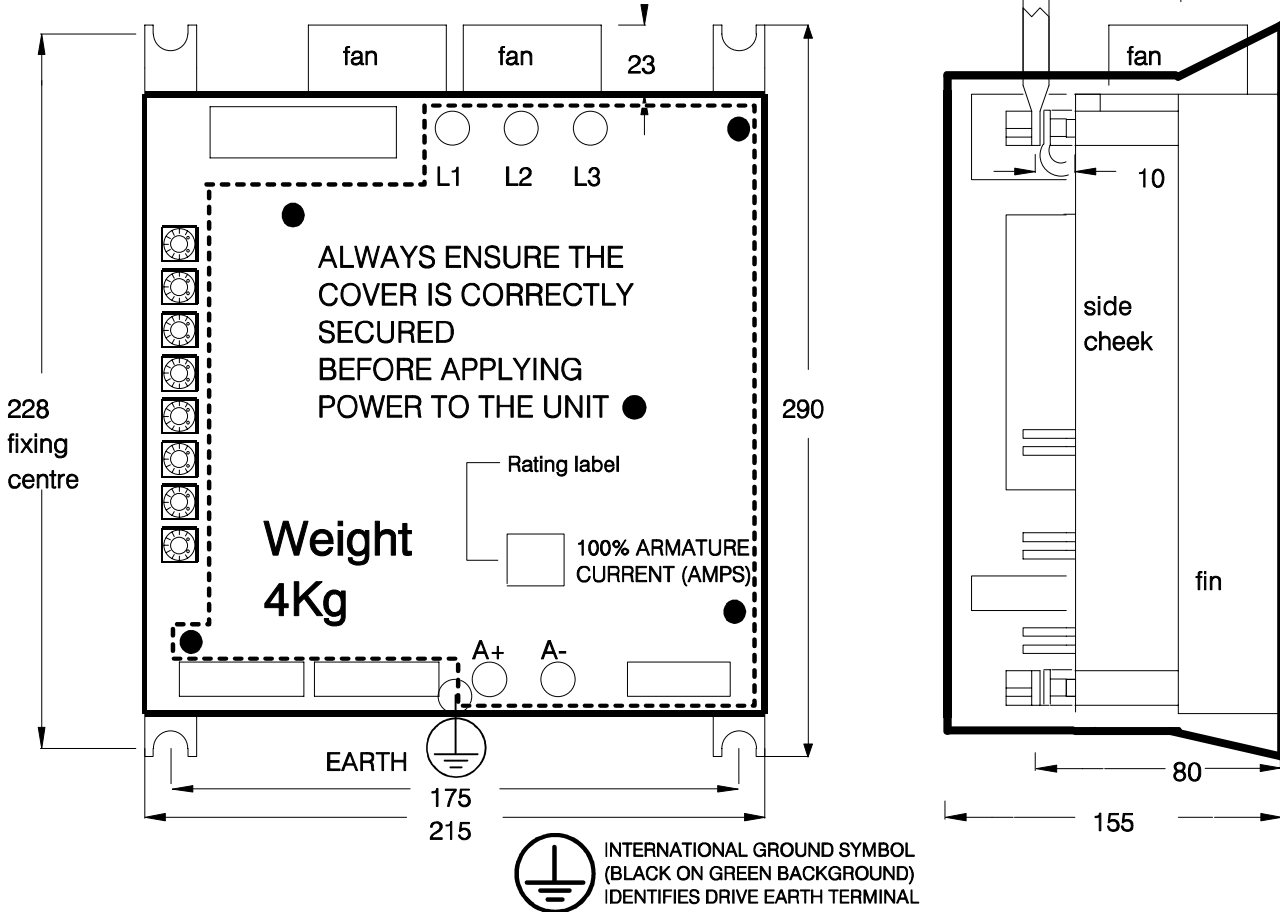

RATING TABLE

(more detailed fuse information on page 29)

(rating depends on motor type)

(35 cubic ft./min = 1 cubic m)

DRIVE MODEL NUMBER	TYPICAL MOTOR O/P			MAXIMUM CONT. AMPS		MAX FIELD AMPS	MAXIMUM FUSE RATINGS				LINE REACTOR TYPE	UNIT AIR FLOW	
	AT 460V KW	at 500V HP	HP	I/P	O/P		AUXILIARY AMPS	POWER AMPS	I_t^2	I_t^2		N natural cfm	F forced watts
SLE 14	14	19	20	27 AC	34 DC	2.5	3.15	50	35	600	LR48	17	N 120
SLE 24	24	32	30	46 AC	58 DC	2.5	3.15	50	60	5000	LR48	17	N 150
SLE 34	34	46	50	66 AC	82 DC	2.5	3.15	50	80	5000	LR120	35	F 250
SLE 44	44	60	60	85 AC	106 DC	2.5	3.15	50	100	11850	LR120	35	F 250

IMPORTANT WARNING. DO NOT ALLOW ARMATURE CURRENT LIMIT TO EXCEED MOTOR RATING. IF THE MOTOR CURRENT RATING IS LESS THAN THE DRIVE RATING, USE MAXIMUM CURRENT PRESET TO REDUCE THE CURRENT LIMIT.

THE FUNCTION SWITCH S1 MAY BE USED TO SET THE DRIVE CURRENT RATING TO 50% WHEN OFF. EG. WITH S1 OFF AN SLE14 WILL BE DERATED TO 17AMPS AT 100% CURRENT OUTPUT.

- 1 +10 volts output. 10mA. Speed pot reference
- 2 MIN INPUT. Also accepts 4-20mA LOOP signals
- 3 Main SPEED INPUT. 0 to +10V. This input is ramped.
- 4 COMMON. 0 volts
- 5 COMMON. 0 volts (COMMON must be earthed for protective class 1)
- 6 AUX. INPUT 0 to +10V. Direct speed or torque according to jumper on card. TORQUE/ SPEED

7 RUN. Drive is inhibited if T7 is open. Connect to _____ 0V to run. Internal pull up to +12V via 4K7.

(WARNING. RUN is an electronic inhibit function. The field remains energised, and all power terminals remain 'live'. RUN must not be relied upon during hazardous operations)

8 COMMON (0V). normally used as tacho common.

9 TACHO feedback input. Full speed scaling by S3/4 Note. If a tachogenerator is used it must be a DC type.

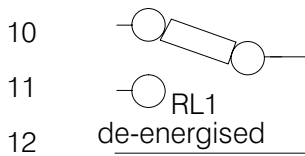

- a) S2 ON RL1 de-energises if current demand > 105%
- b) S5 ON RL1 de-energises if stall timer latches out.
- c) S6 ON RL1 de-energises if speed remains below 5%

If more than one switch is ON the functions are "ANDED"

120V AC, 24V DC 1 amp max contact rating

10	RATINGS ACCORDING TO CSA	
11	VOLTAGE RATING OF RELAY	
12	TERMINALS 10/11/12 MUST NOT EXCEED 30V AC OR 42.4V DC.	

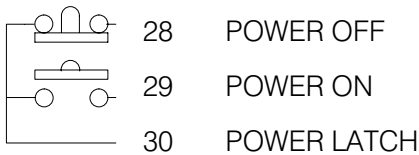

POWER ON/OFF this configuration causes contactor drop out if any alarm is triggered. 24V DC operating voltage on 28, 29, 30

See Application notes in appendix.

31 INTERNAL SLAVE RELAY to drive main supply
32 contactor. 120V AC, 24VDC 1A max contact rating

(Suppress the external contactor coil with an RC snubber (100R + 0.1uF))

The terminals listed below are commonly used signal inputs and outputs found on the top edge terminals. A full listing of the top edge terminal functions is on page 26

- 57 TOTAL SETPOINT OUTPUT (INVERTED) -/+ 10V. 1 KOhm.
- 64 JOP +/- 12V ADJUSTABLE JOG SPEED REFERENCE 10K series resistor
- 66 AUXILIARY SPEED INPUT +/-10V FOR +/-100% SPEED
- 65 AUXILIARY INVERTING SPEED INPUT +/-10V, -/+100%
- 54 CURRENT OUTPUT. 0 to +5V for 0 to 100%. 1 KOhm.
- 55 RAMPED SETPOINT OUTPUT 0 to +10V for 0 to 100% 1 KOhm
- 56 SPEED OUTPUT. typically +7.5V full scale. 1 KOhm.
- 59 ARMATURE VOLTAGE OUTPUT. 0 to -5V represents 0 to 500V. 1 KOhm

All linear signal outputs are buffered by a 1KOhm series resistor

L1 line 1 MAIN INCOMING 3 PHASE SUPPLY
 L2 line 2 INCOMING PHASE ROTATION NOT IMPORTANT
 L3 line 3 terminal torque 35 lb - in. or 3.9 N - m



INTERNATIONAL GROUND SYMBOL (BLACK ON GREEN BACKGROUND) IDENTIFIES MAIN EQUIPMENT GROUND CONNECTION ON UNIT HEATSINK

terminal torque 35 lb - in. or 3.9 N - m

A+ + DC output MOTOR ARMATURE CONNECTIONS
 A- - DC output terminal torque 35 lb - in. or 3.9 N - m

UL Connection information. Copper conductors rated 60C only, or 75C for units rated over 100A.

AUXILIARY SUPPLY PHASING MUST EQUATE TO L1 L2 L3

EL1 Supply for electronics terminal torque 9 lb - in. or 1.0 N - m
 EL2 Supply for electronics Please check supply selection jumpers
 EL3 Supply for electronics

EL1 phase L1
 EL2 phase L2
 EL3 phase L3









THE FIELD OUTPUT VOLTAGE DEPENDS ON THE INPUT SUPPLY CONFIGURATION. see page 16

F+ + DC output 2.5 Amps max. terminal torque 9 lb - in. or 1.0 N - m
 F- - DC output

EF1 FIELD BRIDGE AC INPUT TERMINAL
 EF2 FIELD BRIDGE AC INPUT TERMINAL 2 OR 3 PHASE FIELD EXCITATION OPTION
 EF3 FIELD BRIDGE AC INPUT TERMINAL terminal torque 9 lb - in. or 1.0 N - m



PRESETS

-  MAX sets maximum speed
-  MIN sets minimum speed
-  JOG sets jog speed reference
-  UP RAMP sets acceleration
-  DOWN RAMP sets deceleration
-  STAB sets speed stability
-  IR COMP improves regulation in armature volts feedback mode
-  MAX CURRENT

SWITCHES

- 1** CURRENT RANGE 50%
- 2** RELAY 1, T10/11/12. de-energises if torque demand exceeds 105%
- FULL SCALE FEEDBACK VOLTAGE RANGE SELECTION (TACHO OR Arm V)
- 3** | | |
- 4** | | |
- 30-60 | 60-125 | 125-250 | 250-500
- 5** RELAY 1, T10/11/12. de-energises at STALL
- 6** ZERO SPEED
- 7** CONNECT RAMP INTERNAL
- 8** SPEED FEEDBACK SOURCE OFF TACHO, ON ARM. VOLTS

JUMPER FUNCTIONS

- TORQUE
- SPEED
- 4-20mA
- LOOP
- 50% STALL

PLEASE READ THROUGH THE SET UP PROCEDURE PRIOR TO COMMENCING

Part 1. Visual checklist for complete installation including drive.

Part 2. Initial power up with main contactor disabled.

Part 3. Application of power to motor and running checks.

IMPORTANT. FIRST ISOLATE THE SYSTEM AND DISABLE THE MAIN CONTACTOR. (REMOVE CONTROL SUPPLY FUSE)

PART1 VISUAL CHECK

CHECKING INSTALLATION

All external wiring circuits POWER, CONTROL AND MOTOR (disconnect the controller prior to checking the external wiring with a megger otherwise the controller may be damaged)

For damage to equipment

For loose ends, clippings, swarf etc. lodged in equipment.

INSPECT MOTOR

Inspect the motor brushes, commutator, free rotation of motor and vent fan (if fitted).

ENSURE that rotation of the machinery in either direction will not cause a hazard and that nobody working on the machine can be affected by motor rotation or powering up.

Check the tacho coupling is stiff, not slipping and correctly centred.

PHASE SEQUENCE

The incoming phase rotation is not important but the phase of EL1 EL2 EL3 must be the same as L1 L2 L3. Check that the incoming line feeding EL1 also feeds L1 (usually through contactor and line reactor). Repeat check for EL2/L2 and EL3/L3. Take care if transformers are between the stack and auxiliary supply that there is no phase shift between the input and output of the transformer. It must be delta-delta OR star-star OR star connected auto.

PRESET CHECKING

INITIAL SETTING OF USER PRESETS. A complete description of the customer presets may be found on page 22. The unit is shipped to run with armature voltage feedback at 460V full speed, and full current limit. The speed/torque jumper is in torque mode. (note, this is a precaution for safe commissioning). For complete commissioning commence with the presets set as follows:

Initially set user presets to the following;

- MAX SPEED. fully anticlockwise
- MIN SPEED. fully anticlockwise
- JOG SPEED. midway
- UP RAMP. fully anticlockwise
- DOWN RAMP. fully anticlockwise
- SPEED STAB. midway
- IR COMP. fully anticlockwise
- MAX CURRENT. fully anticlockwise

The commissioning procedure described in this section will take you through the adjustment of the customer functions and presets in a methodical step by step process. This procedure applies to a basic installation. For complex or multi drive installations it may be advisable to initially provide a local setpoint pot and other local controls to enable commissioning of each drive in turn before proceeding to the final system.

FUNCTION SWITCH checking. Switches S1 to S8.

SWITCH 1

CURRENT RANGE When off the drive current rating is reduced to half

SWITCH 2

When ON. de-energises relay 1 if torque demand exceeds 105%. Stall timer is operating (See S5/6)

SWITCH 3 and 4

SPEED FEEDBACK SCALING.

TACHO.	3,4	off	30V	→	60V
or	3	on	60V	→	125V
ARM	4	on	125V	→	250V
VOLTS	3,4	on	250V	→	500V

Note.

For low voltage tachometers there is a 25% scaling function. See page 22. This will reduce all the ranges to 25% of the standard levels.

The MAX SPEED preset gives fine adjustment within the switch range.

FOR SYSTEMS UTILISING TACHOMETER FEEDBACK, THE SAFEST PROCEDURE IS TO COMMISSION THE DRIVE FOR THE FIRST TIME IN ARMATURE VOLTAGE FEEDBACK MODE, WITH THE TACHOMETER CONNECTION REMOVED FROM TERMINAL 9. THIS WILL PREVENT A RUN-AWAY MOTOR IN THE EVENT OF INCORRECT TACHO POLARITY OR COUPLING. IT ALSO ALLOWS THE FULL SCALE TACHO VOLTAGE TO BE MEASURED PRIOR TO USE.

THE SUGGESTED STARTING POINT IS: S3 ON, S4 ON, MAX SPEED FULLY ANTI-CLOCKWISE. GIVES 250V MAXIMUM ARMATURE VOLTAGE.

Note. If a tachogenerator is used it must be a DC type.

SWITCH 5 and 6

RELAY 1. Switches 5 and 6 (and S2) control the function of Relay 1. If more than one function is selected then these functions are logically ANDED.

2,6 on	Relay 1 de-energises if tachometer feedback is zero and current demand > 105%. This gives a useful tacho loss indication
5 on	Relay 1 de-energises on stall condition
6 on	Relay 1 de-energises at zero speed (or zero reference if zero ref interlock mode is adopted, see page 32)
5,6 on	Relay 1 de-energises on stall condition and speed = zero

SWITCH 7

Switch 7 determines the implementation of the setpoint ramp. The S RAMP function is on page 16

7 off	setpoint ramp disconnected internally (drive will not respond to terminal 3 input)
7 on	setpoint ramp connected internally

SWITCH 8

Switch 8 selects the method of feedback. When first commissioning start in Armature Voltage Feedback (AVF). Ensure tacho is disconnected from terminal 9 when using armature voltage feedback.

8 off	OFF for Tacho Feedback
8 on	ON for Armature voltage feedback

TORQUE/SPEED JUMPER

The torque control operates by clamping the current demand from the speed loop, see block diagram. Hence the loop with the lower demand has control. This allows torque control with overspeed limiting, or speed control with over torque limiting. A full description of this function is given on page 19 and 20. It is recommended to set the drive up initially in SPEED mode and then when the speed operation is satisfactory, to commence the TORQUE commissioning. Temporarily park the jumper on one pin to disable.

50% STALL THRESHOLD. A full description of this function is given on page 21. Link the solder pads if the function is required.

4-20mA SIGNAL INPUT LINK.

If the system is going to utilise a 4-20mA signal for the speed reference, the best strategy is to do the initial commissioning with a local speed pot before configuring the 4-20mA links.

When the system is operating correctly with the speed pot, change over to the signal loop mode as described below. Disable the main contactor by remove its coil supply and then operate the drive and monitor the RAMP output on terminal 55. With the loop arranged to provide 4mA, adjust MIN SPEED so that the RAMP output is 0V. With the loop output at 20mA the RAMP output should be 10V, this may require more slight adjustment of the MIN SPEED. Any resulting zero offsets can be trimmed out using the JOG SPEED in zero speed mode (page 13). When the RAMP output is 0 to +10V for a 4-20mA loop signal, the mode change is complete. Alternative setting suggestion using Ohmmeter. With no connection to T 2 and the links made, adjust the MIN SPEED preset until the resistance between T2 and T5 is 250 Ohms. (adjustment range is 0 to 360 Ohms).

Link the 2 pairs of solder pads to allow terminal 2 to become the loop input, terminal 5 the return and adjust MIN SPEED to change the gain. For 0-20mA signals, link the lower pair of solder pads only.

ALARMS

The drive has fast latched alarms:

Stall

Heatsink temperature

Aux. trip this external trip input may be used for motor thermistors or as PLC/RELAY CONTACT operation

If any one of these is triggered, then the drive is immediately inhibited and the main contactor is de-energised. A full description is given on page 15.

PHASE LOSS If any of the auxiliary phases is lost, then this condition will be detected within 20mS and the MAIN CONTACTOR will be de-energised. There is no indicator LAMP.
(note. This function will not work if the internal latch function on T30 is not utilised)

RESETTING ALARMS.

Note. If the contactor control method is by a maintained contact between T28 and T29 then resetting or self resetting alarms may be dangerous. If the contact is still closed after a trip event, then when a reset is activated or occurs naturally (eg cooling down temperature sensor) the main power contactor will immediately energise. To overcome this problem use a de-latching circuit activated by the main contactor. This must cause the maintained contact to open when the main contactor is de-energised.

Terminal 69 is an external trip input. If the resistance to 0V (COM) exceeds approximately 2 KOhms, then the AUX. TRIP ALARM will trip the main CONTACTOR. This may be used for interpole motor protection devices. Relay contacts or PLC open collector outputs may also be used to operate this input. If not used, connect T69 to COM (T68) otherwise the main contactor will not energise.

SAFETY CONSIDERATIONS

Before proceeding to the next stages which involve applying power to the drive, check the following items:

All relevant safety precautions have been observed.

There must be no unqualified or unauthorised personnel allowed near the drive or machine or load.

Do not work on the drive without safety assistance.

The unit has exposed high voltage levels on the power, field and stack areas. See page 23 for identification of high voltage areas

PART 2 INITIAL POWER UP

Please run through the important operating considerations on page 24 before proceeding with the initial power up stage.

The unit is now ready to receive auxiliary power. At this stage it is necessary to use a voltmeter to measure certain signals.

DISABLE CONTACTOR

Before applying power, check that the main CONTACTOR is still disabled. If there is any doubt about the integrity of a particular system, insert a high wattage resistor in series with the armature e.g. a fire element. The following checks will involve measuring certain signals with power applied to the drive.

APPLYING POWER

Verify that the supply select jumpers match your EL1/2/3 supply. The three pairs of supply select jumpers can be found at the right hand side of the board. (see page 22)

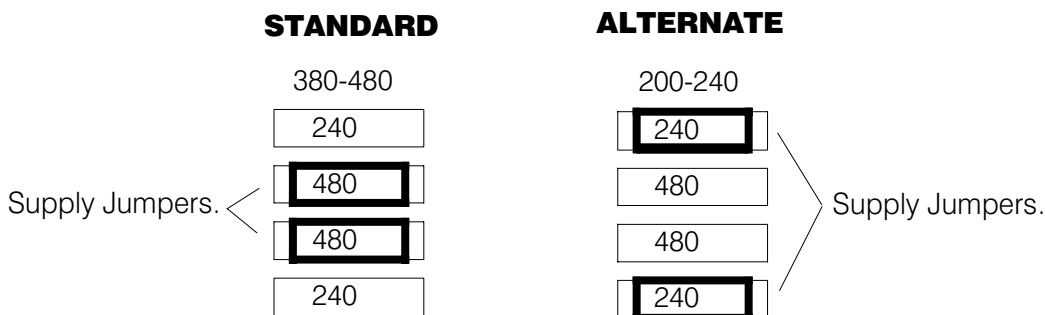

THE FIRST TIME YOU APPLY POWER BE READY TO TURN OFF QUICKLY IN THE EVENT OF A PROBLEM.

- 1) Apply Power.
- 2) Observe illuminated ON lamp.
- 3) Observe TEMP OK lamp is illuminated
- 4) Check the following voltages.

All 3 auxiliary phases should match model and tap selection.

EL1-EL2 Correct phase to phase AC VOLTS should be present
 EL2-EL3 200-240V or 380-480V.
 EL3-EL1

F+ F- Correct Field Voltage Output. (see page 16 for field bridge configuration options)

The field output will be maintained as long as AC power is applied to EF1/2/3. The terminal output voltage may read high if no field connection is made, this is normal and due to peak storage on the field output snubber circuit. If the field is to be de-energised, always remove the supply to EF1/2/3, never open circuit the DC field terminals.

See section 6 page 12 in the appendix for field application circuits

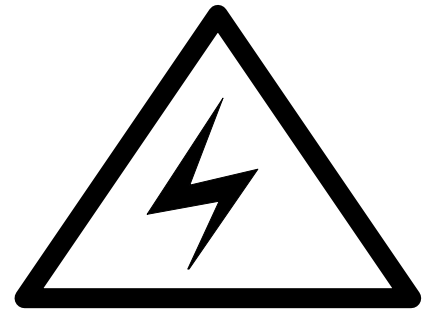

DANGER
ELECTRIC SHOCK RISK

10 VOLT REFERENCES

The remaining measurements are taken with respect to 0V (com)

T1 +10V

T3 +10V to 0V adjustable by speed demand pot. Leave at 0 volts.

POWER ON / OFF CIRCUIT

The next stage is to check the POWER ON/POWER OFF circuit.

WARNING. ENSURE THE MAIN CONTACTOR IS STILL DISABLED.



DANGER
ELECTRIC SHOCK RISK

Operate the POWER ON/POWER OFF buttons and check that the internal slave contact on (T31-T32) opens and shuts . Note the AUX TRIP on T69 must be enabled. (page 26, 10).

The Slave Contact lamp comes on when the contact closes. The SLAVE CONTACT lamp is in the lower right hand corner. Note, if either the STALL LAMP is ON, the TEMP OK LAMP is OFF or the AUX. TRIP LAMP is ON, then the POWER ON function is inhibited. (see block diagrams on page 17 and 28) and the main contactor will not energise.

Check that any other contacts in the POWER OFF line operate correctly.

The next stage will establish that a current demand signal is present. To do this the external run contact must be temporarily shorted (T5-T7). Note, the STALL lamp may come on during this sequence of tests, this is normal. To prevent this from causing interruptions, temporarily put the TORQUE jumper in the TORQUE position, activate POWER ON.

Increase the the speed demand setpoint and observe the RAMP (T55). This should follow the setpoint at the rate set on the UP RAMP preset. The speed demand into the ramp circuit may be derived from numerous sources depending on application, and the analogue processing inputs (T65, T66, T70) may be utilised. Refer to the BLOCK DIAGRAM on page 28 and follow the signal path. NOTE. the resultant RAMP output may be the bi-polar summation of more than one input. More accurate adjustment of the up and down ramps is possible now.

Check that an inverted version of the RAMP output appears on the TOTAL SETPOINT OUTPUT (T57).

Re-park TORQUE jumper on one pin to release current demand.

After being satisfied that the speed demand is functioning, it is possible to check the next stage. This compares the speed demand with the speed feedback and integrates the error to produce a voltage signal. (Current demand ID found on a signal pad just below the MAX CURRENT preset) 0 to -7.5V represents 0 to 150%. The signal can be made to integrate up by arranging for a small speed demand. (a positive ID signal can be found on the MICRO ANALOG PROCESSOR, see section 6 page 13).

TIMER LAMP

The TIMER lamp should come on as the current demand ID exceeds -5.25V (105%).

STALL LAMP

The stall lamp should come on approximately 30 seconds later causing the slave contact to drop out and the TIMER lamp to latch on.

TORQUE CONTROL

For systems involving TORQUE control it should be possible at this stage to establish correct operation of a 0 to +10V input to T6. With the torque link in TORQUE position and a speed demand input (+) the current demand (ID) signal should be controlled between 0 to -5V.

For load sharing applications the current drawn by a master drive is used as a torque reference for a slave drive. In this case the 5V full scale current output signal on terminal 54 (master reference), needs to provide 100% demand. To rescale the TORQUE input on T6 to 5V = 100%, insert a resistor (value < 4K7) in the TFL position. (see layout page 22, and section 6 page 5). Re-check that a 0 to +5V signal on T6 controls ID between 0 to -5V.

Operating the POWER OFF button or opening the RUN line will reset the ramp and current demand circuits.

PART 3 APPLICATION OF POWER TO THE MOTOR

Turn off all power and refit the MAIN CONTACTOR COIL SUPPLY FUSE..

SLAVE RELAY

The switching capability of the slave relay is 1A at 240V AC (The CSA rating is 1A at 125V AC). For contactor coils with higher ratings, an intermediate slave relay should be utilised. A coil suppressor should be fitted to the main CONTACTOR. (a 100R resistor in series with a 0.1uF capacitor across the relay coil)

Ensure all speed demands are set to minimum. Turn on the supply to the drive. Press the POWER ON button. The main CONTACTOR should pull in.

The slave lamp illuminates when the internal slave contact has been energised (T31 and T32)

Press the POWER OFF button. The main CONTACTOR should drop out.

SAFETY WARNING

WARNING. The main contactor should never be operated by any means other than the internal contactor control circuit provided. The thyristors may be damaged if there is no commutation path during turn off, and the internal contactor control circuit ensures the contactor drops out after a suitable delay. Failure to heed this warning will invalidate any warranty.

DO NOT PROCEED FURTHER UNLESS THE POWER ON/OFF CIRCUITS AND CONTACTOR OPERATE CORRECTLY.

POWER ON

POWER ON and close the RUN contact.

LOW SPEED CHECK

Set the speed demand to about 5%. Then slowly rotate the MAX CURRENT clockwise to about 20%. The motor should rotate at 5% of full speed (initially full speed is 250V on armature). If the direction of rotation is incorrect, POWER OFF and remove the supply to the drive. Swap the field connections. Continue as before and progressively increase the speed DEMAND to 50%. During this stage an increase in MAX CURRENT may be required if the TIMER lamp remains on.

MAX SPEED

Increase the speed demand to 100% and adjust MAX SPEED to give the desired full speed. DO NOT ALLOW ARMATURE VOLTAGE TO EXCEED MOTOR RATING. Monitor the armature voltage output on T59. 0 to -5V for 0 to 500V AV. The rating should be found on the motor rating plate. If the motor rating is excessive for the supply used, then do not exceed the supply related ratings on page 2.

FOR SYSTEMS WITH TACHO FEEDBACK. With the motor at the correct max speed for the application (this need not be the maximum capable speed) check the tacho voltage and polarity. STOP THE DRIVE and POWER OFF and remove supplies. Then re-connect the tacho with the -ve wire to T9. Select S3, S4 range to suit tacho voltage. Turn off S8. See worked example page 27. Repeat low and max speed check with tacho feedback.

JOG SPEED

This output is intended as a second speed reference and must be selected by external contacts. It may be shorted to COM (0V) and has a 10KOhm output impedance. See application examples section 6 page 11. The JOG SPEED output on T64 may be connected to T66 to provide ZERO SPEED calibration. In this mode, reduce the speed demand to zero and adjust the JOG SPEED preset until the motor just turns, then back off until it just stops. Re-adjust MAX SPEED for correct tacho voltage.

MIN SPEED

Reduce the speed demand to zero and rotate MIN SPEED to give the desired minimum motor speed.

MAX CURRENT

(check SW1.1 current range switch, if this is off the drive rating is halved)

Adjust the MAX CURRENT preset to the desired level. (Clockwise rotation gives a linear increase in current limit) Full rotation corresponds to the maximum nominal rating of the drive. (NOTE the TIMER lamp comes on if the current demand exceeds 105%. While adjusting the MAX CURRENT preset, the lamp may be used to give an approximate measure of the load current. To do this note the preset rotation angle as the lamp changes state eg. 50% rotation implies the load is drawing approx. 50% of the maximum rating)

UP AND DOWN RAMPS

Final adjustment of the UP and DOWN RAMPS can now take place.

The stability of the SPEED loop can be adjusted. The initial setting of midway is usually optimum for the speed STAB preset. Clockwise rotation of the STAB preset increases the response of the drive. Excessive rotation may cause instability. The current loop (TORQUE) stability may be affected by excessive rotation of the STAB preset, and may be observed with the aid of an oscilloscope.

CURRENT RESPONSE

This check is only necessary if the response is unsatisfactory, or the main fuses are failing

Arrange for a small square wave perturbation (10%) to be imposed on the speed demand. This may be derived from a waveform generator and input via T6 in SPEED mode. Or periodic enabling of the RUN LINE (T7) with a 1V fixed input on T6 is an alternative method. When doing this test, start with the MAXIMUM CURRENT preset fully anti-clockwise and slowly increase clockwise whilst observing the current waveform to prevent unexpected hazards of a mechanical or electrical nature. Do not proceed if loss of control is likely.

Ideal current response

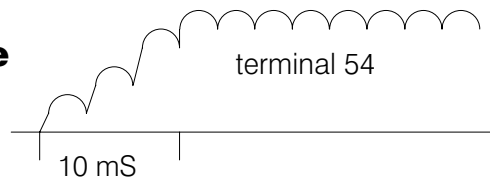

Excessive overshoot

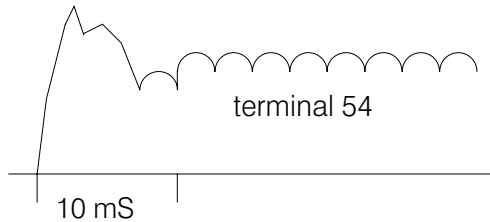

Overshoot of the current may be reduced by anticlockwise rotation of the speed stability preset.

SPEED RESPONSE

If the current response is correct then the speed response should be satisfactory. Over or undershoot may be a result of incorrect power matching between the controller and load. Undershoot suggests insufficient power, overshoot excessive power.

a) Overshoot

b) Ideal response

c) Undershoot

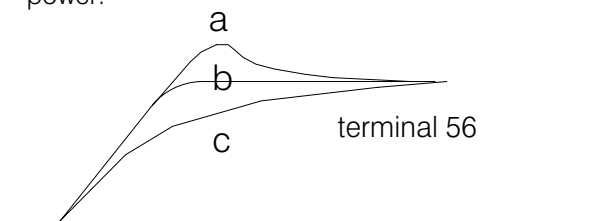

Clockwise rotation of STAB to increase speed of response. Do not allow excessive overshoot to occur. Note if there is excessive overshoot in tacho feedback mode check tacho couplings are stiff and not slipping. Extra response can be gained by adding a 0.1uF capacitor in the DIFF position. (see block diagram page 28 and layout page 22). This provides feed forward of the tacho signal and allows the STAB preset further rotation. Re-check the current response after adding the differential term to make sure there is no excessive overshoot. If the tacho signal is noisy then adding the differential term may lead to erratic current stability. Ensure the tacho signal is clean by observing it on an oscilloscope before implementing the differential term.

POWER OFF

The drive should now be set up and ready to operate. Press the POWER OFF button. The main CONTACTOR should drop out and the motor will coast to rest.

END OF PROCEDURE

These set up procedures are intended as a general guide and can not be expected to cover all possible configurations.

The drive provides protection for the system in the event of certain dangerous conditions. If an alarm is triggered the drive is instantly quenched followed by automatic de-energisation of the main CONTACTOR. The alarm condition remains latched and is indicated by a lamp on the drive.

LAMPS

ALARM FUNCTION



ON
On to run

The ON lamp indicates that the auxiliary supply is energised. **WARNING:** Do not assume that the supply is disconnected if the lamp is off.



STALL
Off to run

The STALL alarm is triggered by a timer according to the current demand. (150% for 30secs, 125% for 60secs, 110% for 120secs). The timer starts timing when the current demand exceeds 105%. This is indicated by the TIMER LAMP.

A number of conditions can lead to excess demand and hence STALL. Incorrect current calibration, incorrect speed calibration, underated motor, jammed or excessive load, incorrect feedback scaling, slipping tacho coupling, supply too low for required output, incorrect motor wiring, excessive speed demand input, in fact any reason that prevents the speed loop from achieving what it is being asked to do.

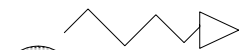

TIMER
Trend indicator

The only way to inhibit the STALL alarm is to prevent the current demand exceeding 105%. To do this the drive must be in TORQUE mode with the external current demand input via terminal 6 10V or below. The STALL alarm may be reset by momentarily shorting T62 (SS) to T61 (+12V)

PHASE LOSS

If any of the auxiliary phases is lost, then this condition will be detected within 20mS and the MAIN CONTACTOR will be de-energised. There is no indicator LAMP.



AUX. TRIP
Off to run

This alarm is provided for external use and is connected via terminal 69. The terminal possesses a 3K3 Ohm pull up resistor to +24V. The alarm will trigger when the resistance to 0V (com). exceeds approximately 2KOhm or the voltage on T69 exceeds 9V. The AUX TRIP input may also be used for main contactor interlock or enable relay logic.



TEMP OK
On to run

This alarm will trigger if the controllers heatsink reaches an excessive temperature. The main contactor will de-energise and the lamp will extinguish. When the heatsink has cooled down to a safe temperature the lamp will come on again. The main contactor will then be able to be energised by an external command. If this alarm is triggered then steps should be taken to improve the ventilation of the unit.



SLAVE
On to run

The SLAVE lamp indicates that the slave relay for the main contactor is energised, and the internal contact across terminals 31 and 32 is closed.

FIELD

The field bridge can be configured to suit various output voltages. It may be supplied separately or from the auxiliary supply fuses. Fuse rating see page 29. The field output current rating is 2.5A DC maximum. (see section 6 page 12).

WARNING. Systems utilising the AV (T59) signal for field weakening must not use armature contactors.

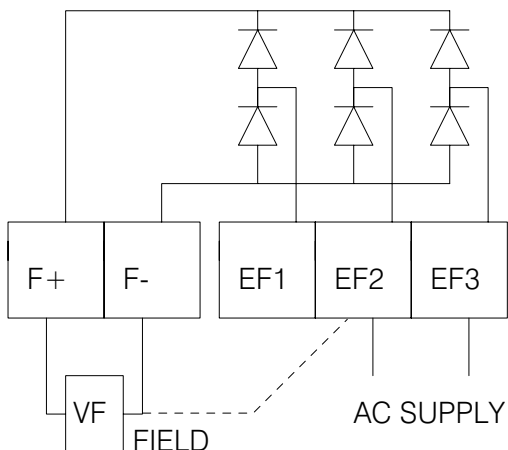

2 phase supply AC	120	208	240	380	415	480
Field voltage DC VF = 0.9 x AC	108	187	216	342	373	432
VF = AC X 0.45	54	94	108	171	187	216

Dotted line shows alternate half wave connection

To make the half wave connection remove the connection from F- and remake it to EF2. DO NOT BREAK THE FIELD CONNECTION UNLESS THE FIELD CURRENT IS ZERO

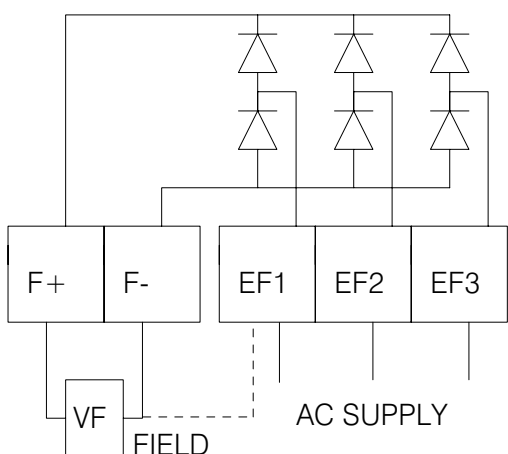

3 phase supply AC	120	208	240	380	415	480
Field voltage DC VF = 1.35 x AC	162	281	324	513	560	648
VF = AC X 0.67	81	140	162	256	280	323

Dotted line shows alternate 2/3 wave connection

To make the 2/3 wave connection remove the connection from F- and remake it to EF1. DO NOT BREAK THE FIELD CONNECTION UNLESS THE FIELD CURRENT IS ZERO

S RAMP

The S RAMP function is an option that allows the shape of the speed demand ramp to be modified.

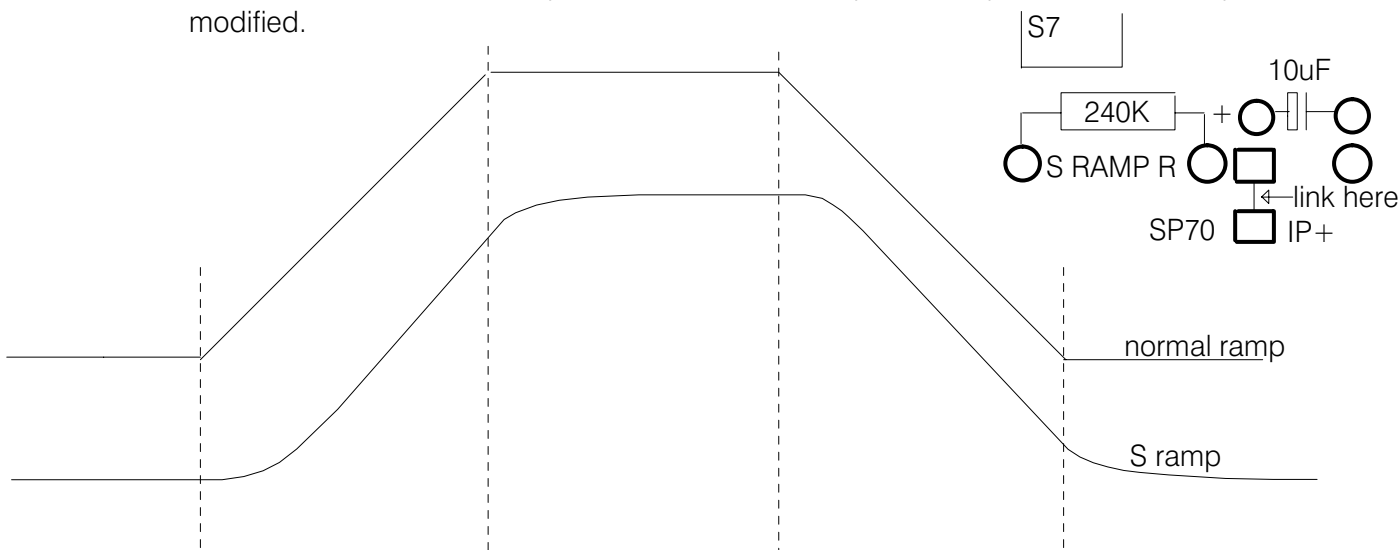

To implement the S RAMP function insert a 240Kohm resistor and a 10uF capacitor in the positions shown, then link the solder pads and turn S7 function switch off. Note this function utilises SP70 (Signal Pad 70), the auxiliary input which appears on terminal 70. This may also be linked to terminal 6 via the speed jumper which will affect the S ramp function. Park the SPEED jumper on one pin to enable the S Ramp function. (note that the length of the S shaped tails is roughly proportional to the capacitor size. Other values may be used if desired. The 10uF cap gives tails of 1 second approximately)

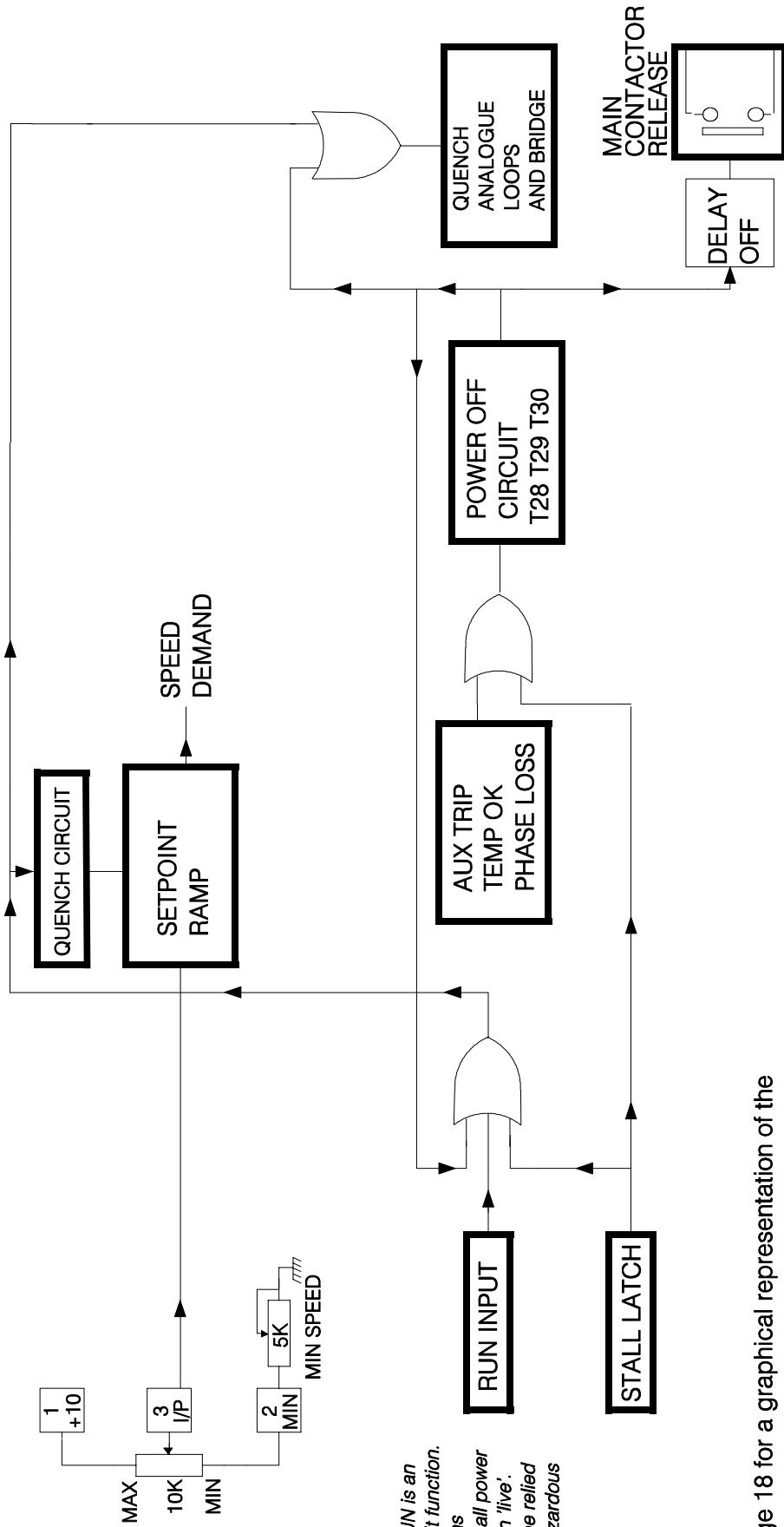

(WARNING. RUN is an electronic inhibit function. The field remains energised, and all power terminals remain 'live'. RUN must not be relied upon during hazardous operations)

Refer to page 18 for a graphical representation of the stopping modes.

OPERATION

List of possible sources of inhibit request.

- 1) Stall timer latch is triggered due to overload FAST ACTION REMOVE POWER
- 2) External run line is opened
- 3) Excessive heatsink temperature FAST ACTION, REMOVE POWER
- 4) Latched alarm FAST ACTION, REMOVE POWER
- 5) Power off request FAST ACTION, REMOVE POWER

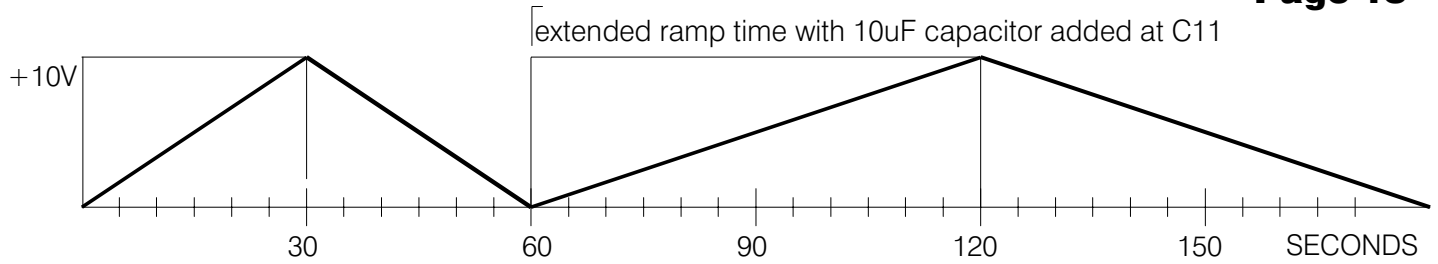

Thin line: Speed demand. Thick line: RAMP output T55. All ramps fully anticlockwise.

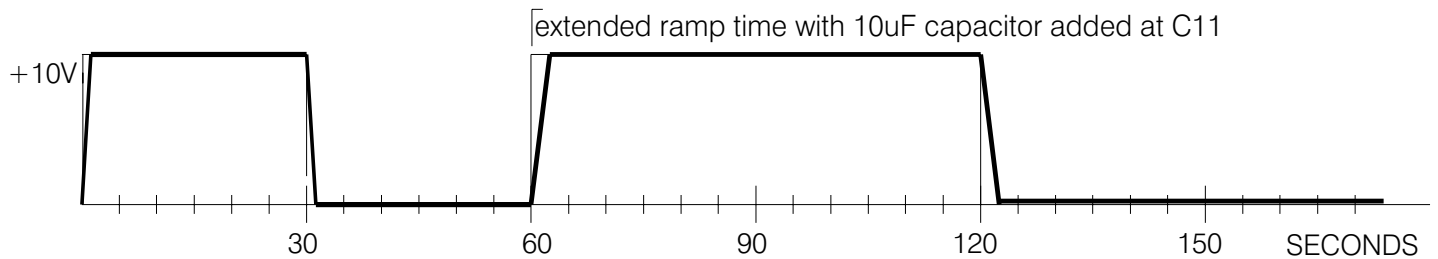

Thin line: Speed demand. Thick line: RAMP output T55. All ramps fully clockwise.

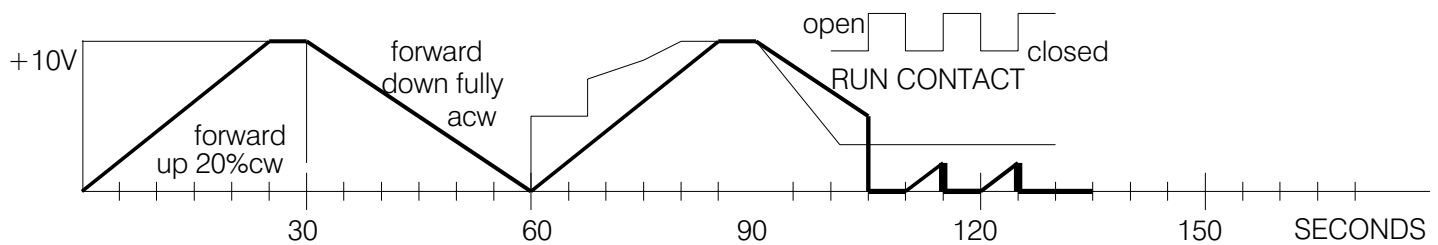

Thin line: Speed demand. eg. from external pot. Thick line: RAMP output T55.

STOPPING MODES

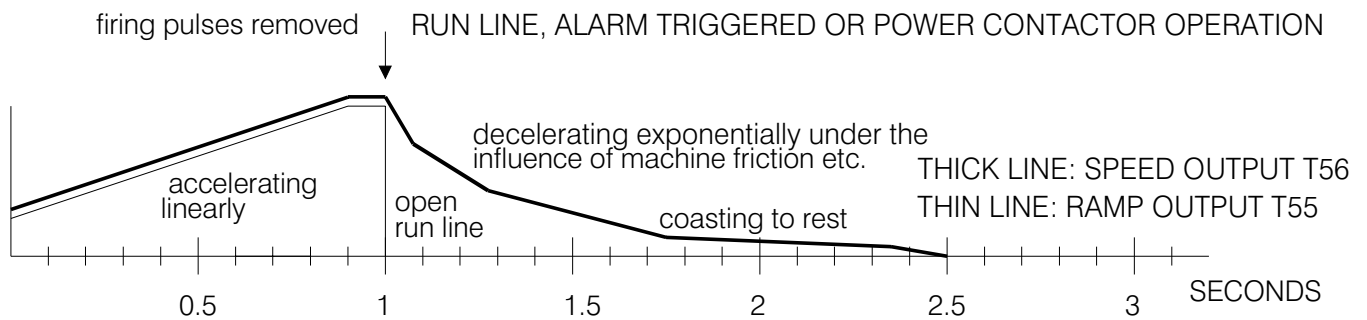

When the run line is opened, the ramp is quenched, and firing pulses removed, the motor coasts to rest.

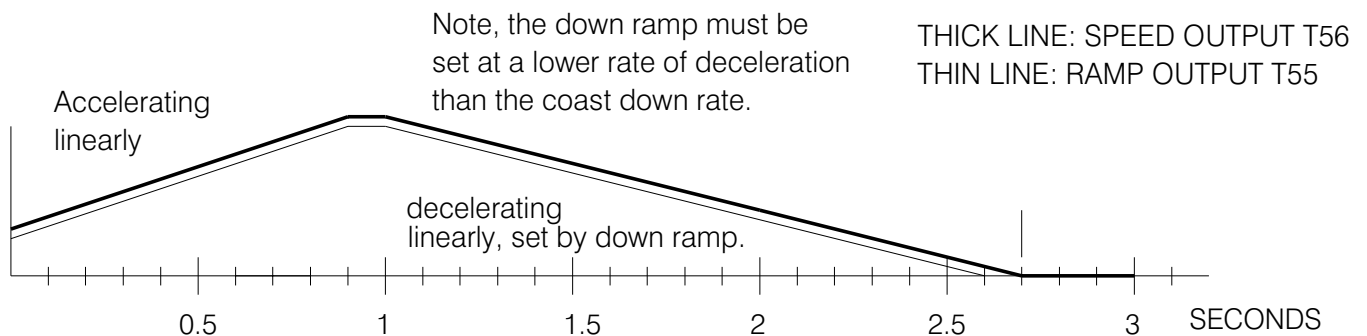

To ramp down under control of the DOWN RAMP preset, open circuit the speed reference to the drive.

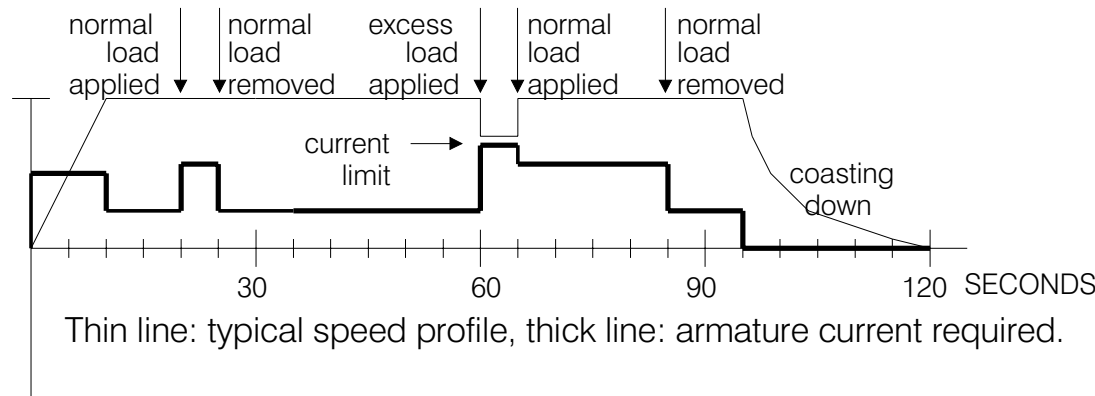
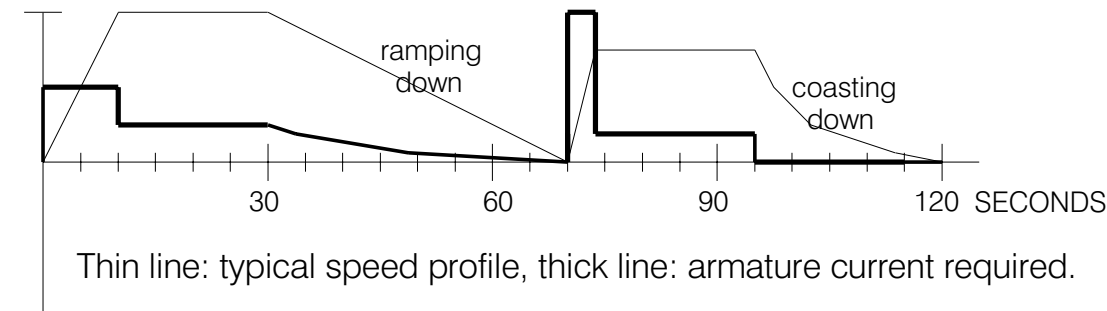

TORQUE FUNCTIONS

Facilities are provided for controlling the torque (current) instead of speed (volts) of the motor. This is achieved by allowing the current demand to be clamped by an external input. NOTE the current demand is provided by the speed loop and hence the speed loop must always be asking for more current than the clamp level. This technique gives automatic overspeed limiting.

TORQUE FUNCTIONS

Signal input Terminal 6. The external signal is scaled to give 100% of the preset limit for +10V. 0% for 0V. The Torque jumper allows the current limit to be programmed by an external signal.

THIS GRAPH SHOWS HOW IN TORQUE CONTROL THE CURRENT IS CLAMPED AT THE DESIRED LEVEL ONLY AS LONG AS THE SPEED DOES NOT TRY TO EXCEED THE LEVEL SET BY THE SPEED DEMAND.

A TYPICAL EXAMPLE OF WHERE THIS MIGHT OCCUR, IS WINDING MATERIAL WITH THE WINDING REEL IN TORQUE CONTROL. IF THE MATERIAL SUDDENLY GOES SLACK, THE REEL WILL TRY TO SPEED UP. THE SPEED LOOP WILL CATCH IT.

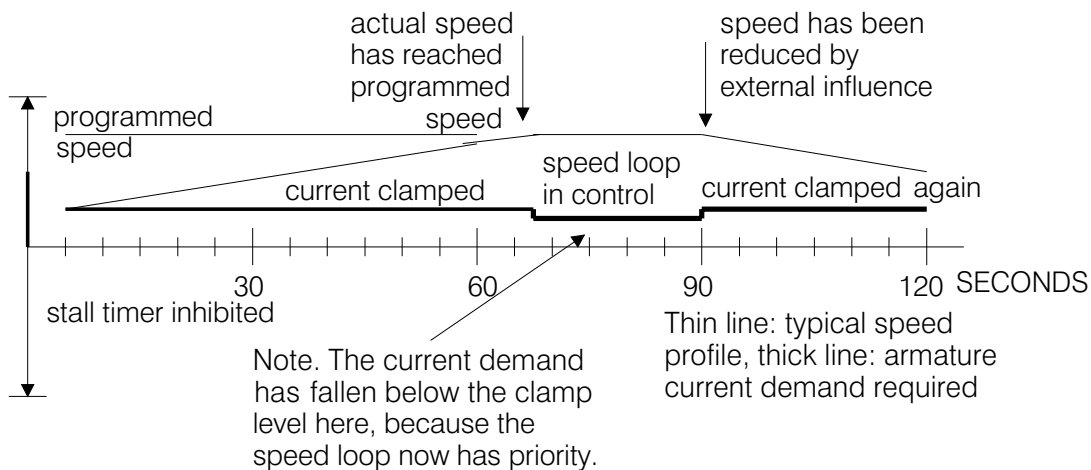

NOTES. The torque input signal is used to clamp the upper limit of the internal current demand signal before it is fed to the MAX. CURRENT presets. If the speed loop does not require current greater than the clamp level, then it will have control.

This is a 2 position jumper which controls the function of terminal 6 (AUX). A schematic is shown below

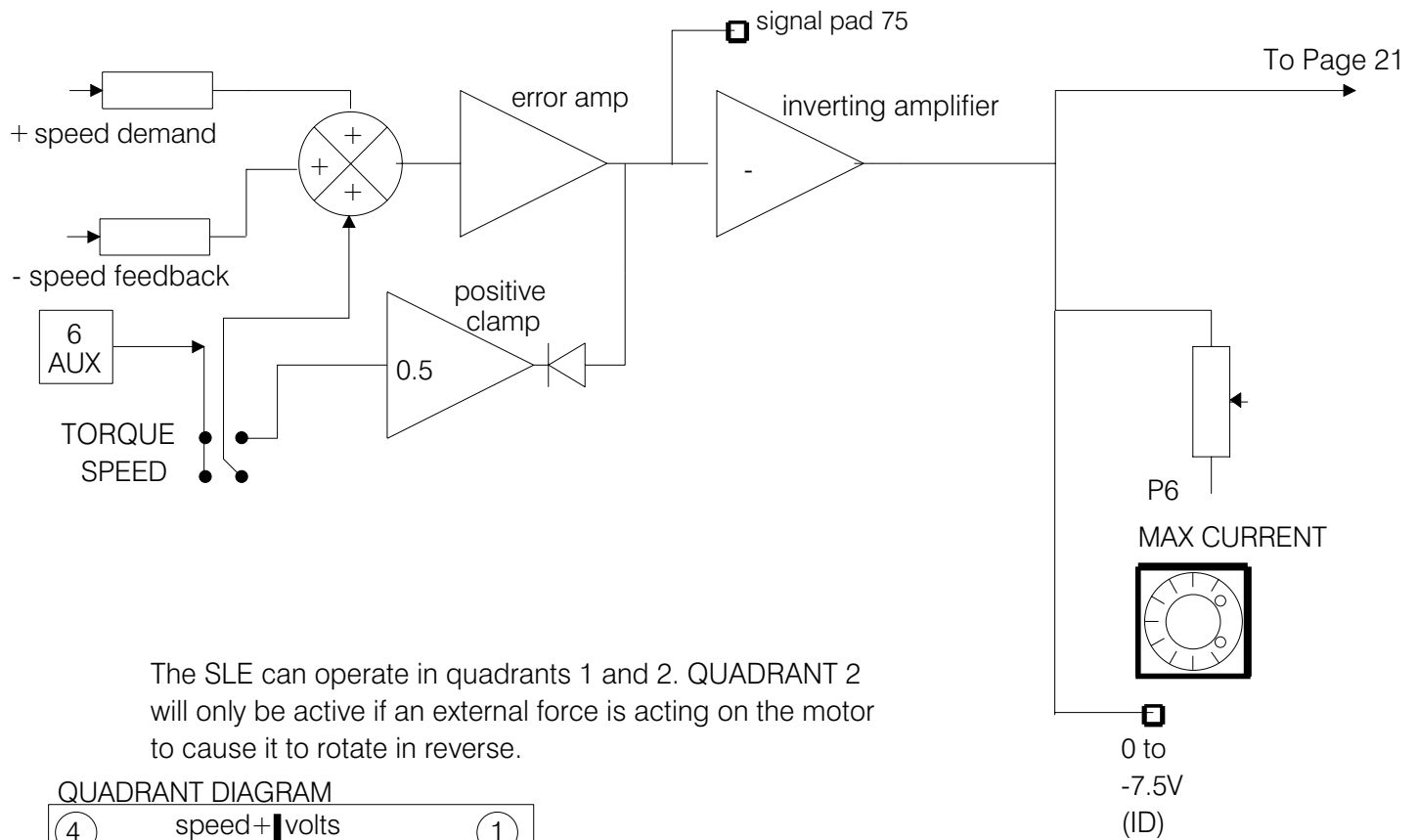

The SLE can operate in quadrants 1 and 2. QUADRANT 2 will only be active if an external force is acting on the motor to cause it to rotate in reverse.

QUADRANT DIAGRAM

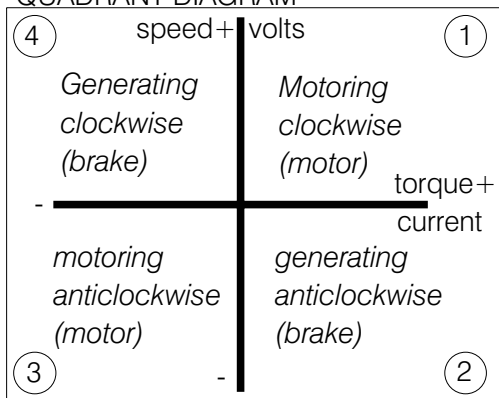

The TORQUE clamp operates in 1 and 2 on the positive current

STALL TIMER

To achieve the desired speed, the outer speed loop provides the current loop with a CURRENT DEMAND signal. The timer itself is inhibited while the current demand signal lies below -5.25V (-5V represents 100%). Whenever the signal traverses into the area between -5.25V and -7.5V the stall timer starts to integrate. The rate of integration is proportional to the magnitude of the signal over 105%.

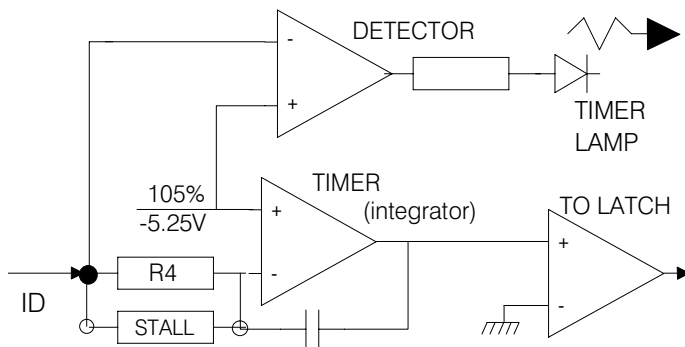
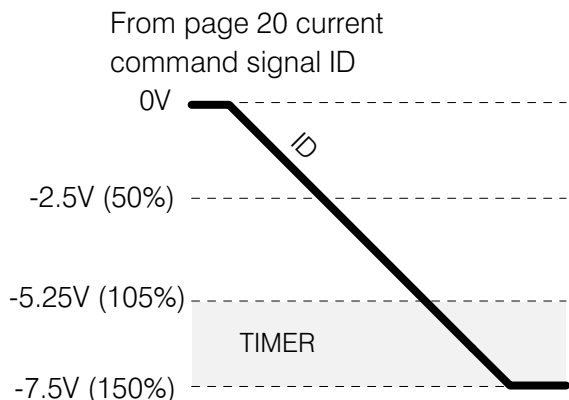

To reduce the stall time add a resistor in the stall position. See layout on page 22. 3M9 = 15secs, 2M2 = 7secs, 1M = 3secs.

SCHEMATIC OF STALL TIMER

The time taken to integrate a 150% level is approximately 30 seconds , 125% for 60 seconds etc. Thus the stall timer allows smaller overloads for longer periods. When the current demand falls below 105% after being in overload, providing the timer has not timed out, then the integrator starts to integrate back down again. This feature provides a historical store of the behaviour of the current demand. If the timer has come close to tripping and then the demand falls below 105%, it will need to spend at least a further 30 seconds at 50% to fully reset the integrator. The effect of this feature is to have the ability to provide complex overload behaviour, and trip only when the time average overload is exceeded.

50% STALL THRESHOLD

FUNCTION: TO ALLOW HIGH PEAK CURRENTS

This changes the level at which the stall timer integration starts to 52.5%. The advantage of this feature is it allows the 150% current to be achieved, but provides protection above 52.5%. The stall time is reduced by half. When using this feature it is important to remember that the maximum current rating of any model is unchanged, and the trip level is reduced.

RESISTOR	THRESHOLD	OVERLOAD	RATIO	PEAK %
LINK	50%	150%	1 : 3	300%
100K	60%	150%	1 : 2.5	250%
220K	70%	150%	1 : 2.1	210%
470K	80%	150%	1 : 1.87	187%
1M	90%	150%	1 : 1.66	166%
OPEN	100%	150%	1 : 1.5	150%

Other threshold levels can be implemented if a resistor is used instead of a link.

This layout may be used to log preset and jumper positions

LAMPS

Anticlockwise Midway Clockwise

on condition stall timer tripped stall timer active

MAX SPEED
 Rotate clockwise to increase speed. Change range with S3 and S4.

MIN SPEED
 Rotate clockwise to increase minimum speed. Also use to adjust 4-20mA loop burden resistor.

JOG SPEED
 Rotate clockwise to increase level of positive jog speed adjustment, and anti-clockwise for negative

UP RAMP
 Rotate clockwise to increase acceleration, note the limit may be determined by the available power

DOWN RAMP
 Rotate clockwise to increase deceleration, note, the limit is determined by the natural coast down rate.

STAB
 Rotate clockwise to increase response. Excessive rotation may cause instability.

IR COMP
 Rotate clockwise to compensate for armature resistance losses. Excessive rotation may cause instability. (do not use with tacho)

MAX CURRENT
 Rotate clockwise to increase current limit.
TORQUE OR SPEED MODE JUMPER. This jumper alters the function of the AUX input on terminal 6. 4-20mA. Link both and terminal 2 is input, 5 return. MIN SPEED to set zero.

link to implement 50% STALL THRESHOLD

TEMP OK indicator shows that the drive heatsink is at a satisfactory temperature

ON **STALL** **TIMER**

70 69 68 67 66 65 64 63 62 61

60 59 58 57 56 55 54 53 52 51

CURRENT **TIMER RL1** **SPEED RANGE** **STALL RL1** **ZERO RL1** **RAMP** **TAC/AV**

ON

S3 off on S3 off on S4 off on S4 off on

30-60V 60-125V 125-250V 250 to 500V

SC COM IP+

S RAMF SP70 IP+

SP81 TO 90

SP71 TO 80

R S

AUX TRIP Terminal 69

MICRO ANALOG PROCESSOR

SIGNAL PADS

ID Current demand signal 0 to -7.5V

STALL

TORQUE **SPEED** **4-20mA** **LOOP** **STALL**

50% **TEMP OK**

DIFF

0.1

1 2 3 4 5 6 7 8 9 10 11 12

POWER CONTACTOR SLAVE

OFF ON LATCH

TACHO

W O W

W O W

COM

0 +

EL1 EL2 EL3

240 OR 480 PAIR

240V 480V 480V 240V

SUPPLY SELECT

240 OR 480 PAIR

240V 480V 480V 240V

SUPPLY SELECT

240 OR 480 PAIR

240V 480V 480V 240V

SUPPLY SELECT

On when internal slave contact energises Terminals 31 and 32

SLAVE

100% ARMATURE CURRENT DEMAND

Rating label

Model label



The relay RL1 on terminals 10/11/12 is shown here in a de-energised state

A+

A-

F+ F- EF1 EF2 EF3

SAFETY WARNING THE SHADED AREA OF THE UNIT IS AT DANGEROUS POTENTIAL. DO NOT TOUCH ANY PART OF THE ELECTRONICS AND PRINTED CIRCUIT BOARD IN THE SHADED AREA. TAKE CARE TO KEEP CLEAR OF THE HIGH POTENTIAL AREA

ALWAYS ENSURE THE COVER IS CORRECTLY SECURED BY THE 4 CLIP POSTS BEFORE APPLYING POWER TO THE UNIT

COVER OUTLINE SHOWN BY DOTTED LINE

ALWAYS USE INSULATED ADJUSTMENT TOOLS WHEN CHANGING USER PRESETS

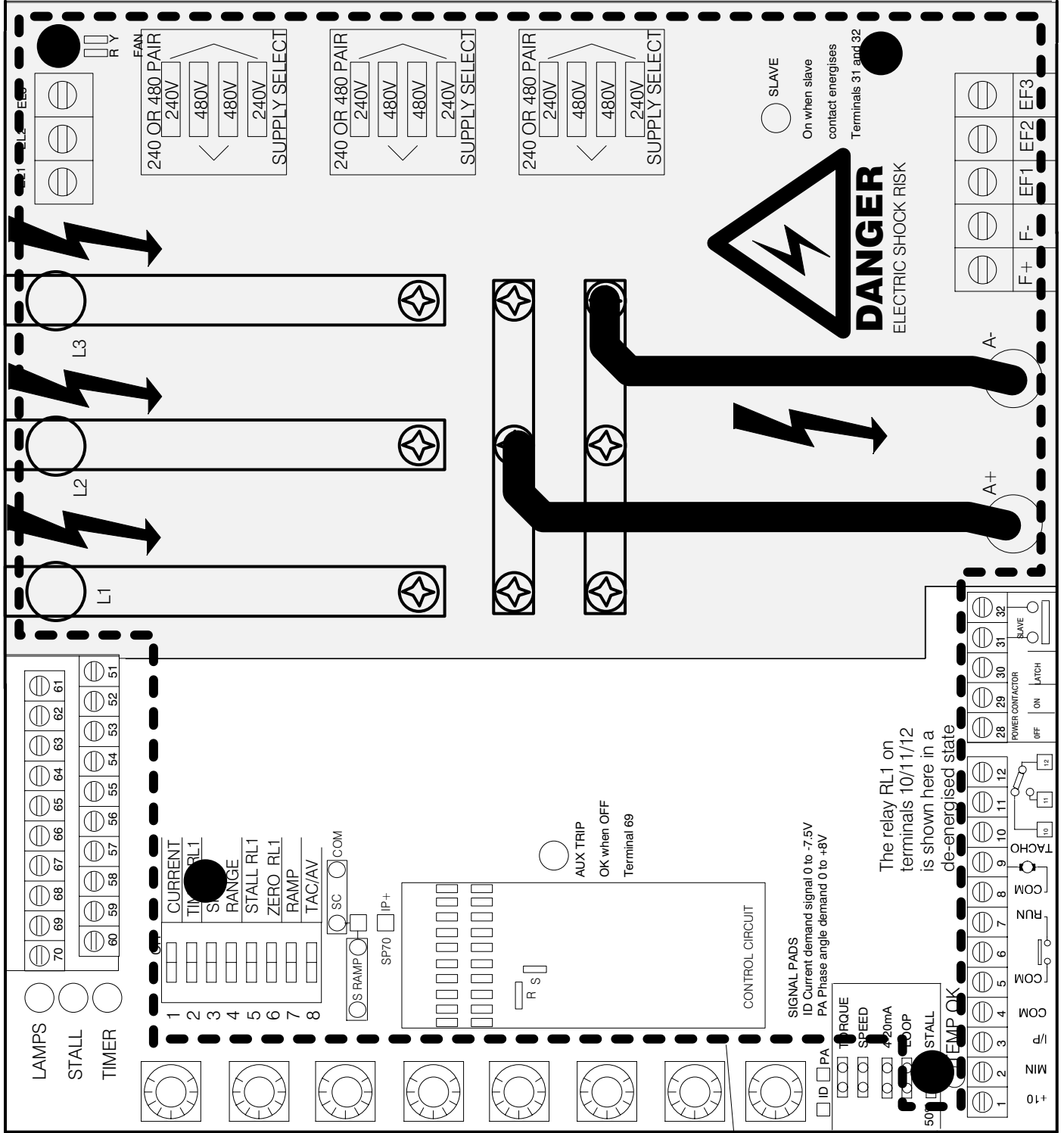

The relay RL1 on terminals 10/11/12 is shown here in a de-energised state

If the problem is not covered by this chart, repeat the set up procedure and try to determine at which step the problem is highlighted.

Symptom	possible reason	page	possible remedy	page
1 main contactor will not energise	1 alarm tripped	15	1 find alarm cause	15
2 no alarms but still no main contactor	2 power on/off not properly configured	28	2 check system and wiring of T28/29/30	28
3 slave contact lamp comes on but no main contactor	3 wiring or contactor coil supply problem	3	3 coil supply fuse or wrong supply volts	

Symptom	possible reason	page	possible remedy	page
1 speed changes when ancillaries energised	1 interference coupled onto tach feedback		1 suppress noise or screen/filter tach	
2 incorrect speed and stall timer off	2 speed calibration not correct	22/27 28	2 check feedback source full scale	22/27 28
3 incorrect speed and speed feedback cal. is correct	3 speed demand is incorrect	27/28	3 trace all speed I/P sources to total setpoint O/P. T57	27/28

Symptom	possible reason	page	possible remedy	page
1 speed too low, stall timer trips	1 insufficient motor torque for load	19/20 21/28	1 check current cal. of drive and motor	22 13
2 same as above but current cal. correct	2 field voltage is too low	16	2 check field voltage	16
3 speed too high and stall timer trips	3 excessive speed demand due to feedback cal.	22/27 28	3 check feedback source full scale	22/27 28

Symptom	possible reason	page	possible remedy	page
1 intermittent stall trip after some months	1 original current setting marginal		1 re-check current calibration	
2 temp trip triggered	2 overheated drive unit		2 improve airflow to unit	
3 aux. trip triggered, thermistor on T69	3 overheated motor		3 increased cooling for motor.	4/15

For further information on the cause of problems, refer to the block diagram on page 28. This is surrounded by boxes from 1 to 24, which contain keynote comments relating to each section of the drive unit. OBSERVE SAFETY

IMPORTANT OPERATING CONSIDERATIONS

This is a summary of the essential parameters that should be checked prior to allowing power to the motor. You must be able to put a tick against every section. Failure to comply with these requirements may cause incorrect functioning or damage to the drive and/or installation and will invalidate any warranty.

POWER ENGINEERING

- 1) All external fuses must be of the correct rating and type. The I t rating must be less than the rating specified in the rating table. This includes main and auxiliary fuses.
- 2) Check the 3 phase auxiliary supply voltage is compatible with the drive voltage rating set up. (dual range voltage selectors on power board)
- 3) Check the 3 phase auxiliary supply phasing on EL1/2/3 equates to the phasing of the main stack supply on L1/2/3.
- 4) The drive and 3 phase supply current and voltage ratings, should be compatible with the motor and load requirements. (both armature and field, current and voltage).
- 5) The cables and termination should be rated to carry the rated current with no more than a 25C temperature rise, and all terminations should be tight.
- 6) The main contactor must be operated by the slave contact on terminal 31 and 32, and the correct operation of the slave verified prior to applying power to the motor .
- 7) The wiring should be checked for short circuit faults. AC power to ground, signal and control. DC power to ground, signal and control. Signal to control and ground. Disconnect the drive for wiring tests using a megger.
- 8) The engineering standards employed must comply with any local, national or international codes in force. Safety requirements take priority.
- 9) A substantial protective earth connection in accordance with relevant codes should be made to the terminal provided.
- 10) A protective earth connection must be made to the control COMMON (T5) to ensure that the installation complies with protective class 1 requirements.

tick when checked
✓

CHECKED	<input checked="" type="checkbox"/>
CHECKED	<input type="checkbox"/>
CHECKED	<input type="checkbox"/>
CHECKED	<input type="checkbox"/>
CHECKED	<input type="checkbox"/>
CHECKED	<input type="checkbox"/>
CHECKED	<input type="checkbox"/>
CHECKED	<input type="checkbox"/>
CHECKED	<input type="checkbox"/>

MECHANICAL ENGINEERING

- 1) The motor and load if fitted must be free to rotate without causing damage or injury, even in the event of incorrect rotation direction, or loss of control.
- 2) The emergency stopping and safety procedure, including local and remote actuators must be checked prior to applying power to the motor.
- 3) The installation must be clean and free of debris such as swarf, clippings, tools etc. The enclosure must be adequately ventilated with clean dry filtered air.

CHECKED	<input type="checkbox"/>
CHECKED	<input type="checkbox"/>
CHECKED	<input type="checkbox"/>

CONTROL ENGINEERING COMMISSIONING PROCEDURES

- 1) The speed and/or torque references should be traced through to the current demand stage. See page 11 and 12
- 2) The drive should be set up to run in armature voltage feedback mode initially to enable the tacho polarity and amplitude (if fitted) to be found.
- 3) For systems with multiple control elements and or complex interactive loop components, initially run the drive in a basic stand alone arrangement to verify performance
- 4) For systems employing torque control it is recommended to set up in basic speed mode first in order to establish correct speed loop functioning and calibration. Note:- With the torque/speed jumper in torque mode the drive will not run without a torque demand on terminal 6.
- 5) When pre-testing systems without a motor being available it is possible to use 2 mains light bulbs in series as a dummy load for the armature in AVF mode, or the field. This will allow the essential static operation to be verified, and approximate scaling to be accomplished.

Apart from relays, the unit is completely static and requires little routine maintenance. Periodic cleaning should be done with a vacuum cleaner and small soft paint brush. Check all connections for tightness and discoloration which might indicate localised heat.

In the event that the unit must be dis-assembled, only qualified personnel familiar with power engineering should be employed.

The unit is constructed with the minimum of mechanical parts. To dis-assemble follow the sequence outlined below.

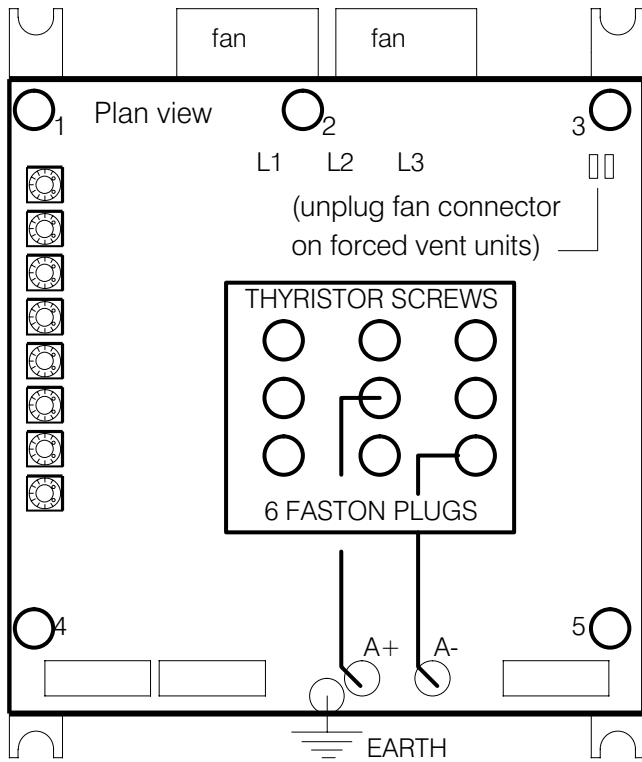

- 1) First remove side cheeks. Loosen 2 hex screws with allen key at both sides. Slide side cheeks off taking care not to lose retaining nuts. To remove fan board on vented units undo 3 M4 fixing screws, release fan connector plug.
- 2) To release the power card, first unscrew both armature leads from thyristors to improve access and then disconnect 6 faston plugs from thyristors. These may be fairly tight, try not to damage red and yellow wires. Then remove remaining thyristor screws.
- 3) Remove plastic screws 1/2/3/4/5 and lift off power card, and recover 5 supporting pillars. Unscrew temp sensor for total removal. Assemble in reverse order taking care to observe correct torque (3.1 Nm, 0.31kpm, 2.3 lbf +/ -20%) when tightening thyristors. Make sure interconnection plugs are properly mated.

UG101803 ISS 8

MAIN FUSES

The main external supply fuses must be semi-conductor fuses of the correct rating. Use of any other type may not afford adequate protection and may result in damage to the unit. Product warranty will be invalidated unless the correct type and rating of fuse is used. See rating table for INPUT FUSE. (See Page 29)

CHECKING FOR DAMAGED THYRISTORS

Using an Ohmeter in the 20 MOhm range, check for open circuit condition between A+ and L1/L2/L3 and A- and L1/L2/L3. (6 readings in all) If any reading is less than 20 MOhm then suspect a damaged thyristor. When taking readings allow a few seconds for the snubber circuit to charge up to the meter excitation voltage..

Change the range on the meter to 200 Ohms and measure the gate to cathode resistance of each thyristor. (Between the red and yellow leads on the gate connections). Any reading outside the range 5 to 35 Ohms indicates a damaged thyristor.

When thyristors are damaged it is sometimes possible that the associated gate firing components may also be damaged. This is why it is recommended that units be returned to the supplier for professional attention. A unit that has been returned for service will automatically be fully tested to specification on all parameters, and the expert knowledge base available will usually be able to reveal the cause of failure and suggest action for future prevention of the problem.

SPARES

Recommended minimum spares
 A complete set of fuses
 2 Thyristors MCC 72-14io1

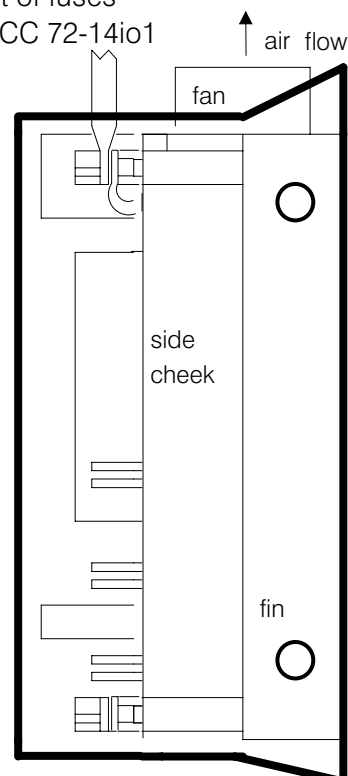

All models have auxiliary signal terminals, marked 51 to 70, on the upper edge of the card. NOTE the signal terminal numbering system is common to other SPRINT ELECTRIC drive units. Control terminal torque T51 - T70 7 lb - in. or 0.8 N - m

T51 -24 volt rail. unregulated, unprotected, may vary between -36V and -18V depending on loading and supply. This rail is primarily provided to supply external signal relays used in conjunction with T52 T53 T60. Output capability 25mA. Do not overload or short this rail.

T52 ST Stall relay driver. PNP open collector output. -40V max voltage when off. 25mA max current when on. Note a flyback diode for the relay coil is included in the drive circuitry.

T53 ZS Zero speed relay driver. PNP open collector output. -40V max voltage when off, 25mA max current when on. Note a flyback diode for the relay coil is included in the drive circuitry.

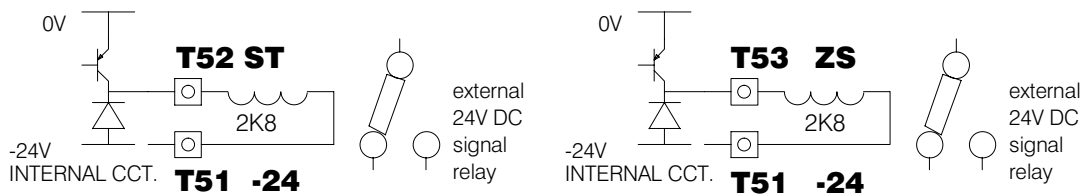

T54 IO 0 to +5V represents 0 to 100% current . 1K series buffer resistor. Maximum output 7.5V for 150% demand.

T55 RO Ramp output. 0 to +10V represents 0 to 100%. 1K series buffer resistor. Short circuit protected.

T56 SO Speed output. Typically 7.5V full scale. Adjustment of MAX SPEED preset will alter the full scale reading from 4V (ACW) to 9V (CW). 0V to full scale represents 0-100%. 1KOhms series buffer resistor.

T57 DO Demand output. 0 to -10V represents 0 to +100% speed demand. This is the final summation of all the speed demand inputs. 1K series buffer resistor.

T58 COM Common. 0V for drive electronics.

T59 AVO Armature voltage output. 0 to -5V represents 0 to +500V armature voltage. 1KOhms series resistor.

T60 TIM TIMER relay driver. PNP open collector output. -40V max. voltage when off, 25mA max. current when on. A flyback diode is included. This driver is de-energised when the stall timer starts to integrate (current demand exceeds 105%).

T61 +12 regulated rail. 10mA capability, short circuit protected. This rail provides power to the drive electronics, the drive will not function while this rail is shorted. If it is used for external circuitry please ensure that it is buffered from possible interference by inserting a series resistor as close as possible to T61. A value between 10 and 100 Ohms should be adequate.

T62 SS STOP/START this input can be used to latch or unlatch the stall circuit. It may be necessary to de-couple this with a 0.1uF capacitor to COM. Momentary close to -12V T63 to latch, close to +12V T61 to unlatch.

T63 -12 regulated rail. 10mA capability, short circuit protected to 0V. This rail provides power to the drive electronics, The drive will not function while this rail is shorted. If it is used for external circuitry please ensure that it is buffered from possible interference by inserting a series resistor as close as possible to T63. A value between 10 and 100 Ohms should be adequate.

T64 JOP alternate speed reference output. -12V to +12V, 10K series resistor. Note this output may be shorted to COM (0V) if desired. Also the JOG PRESET span is mainly between +/-2.5V to make this a useful zero speed offset signal when input into T65 or T66.

T65 -IP ramped aux inverting input -10V represents 100%. 100K input impedance. Note: for + inputs (- demand), the internal ramp clamps at -5%. This input is a true bipolar summing input which inverts the incoming reference.

T66 IP ramped auxiliary input 10V represents 100%. 50K input impedance true bipolar non inverting summing input.

T67 +24 volt rail. Unregulated, unprotected. may vary between 36V and 18V depending on loading and supply. Output capability 25mA. Do not overload or short this rail. T68 COM common. 0V for drive electronics.

T69 AUX. TRIP. Input enable for main contactor slave. It must be connected to COM (T68) to enable the POWER ON/OFF circuit. It has a 3K3 pull up resistor to +24V, and a 9V operating threshold. It may be used with thermistors or relay logic or tied to COM. The AUX. TRIP lamp illuminates when the input exceeds 9V or If it opens. The lamp will come on and the main contactor will drop out and unlatch.

T70 IP Direct speed input. 0 to +/-10V for 0 to +/-100% demand. This input bypasses the setpoint ramp circuit. It is connected to the speed jumper pin. It is an alternative to Terminal 6. Input impedance 470KOhms. True bipolar non inverting direct summing input.

WARNING. TAKE CARE NOT TO TOUCH ANY HIGH POTENTIAL PARTS ON THE UNIT WHILST PROBING THESE TERMINALS

IMPORTANT SAFETY NOTES

READ AND UNDERSTAND THIS MANUAL BEFORE
APPLYING POWER TO THE SLE MOTOR DRIVE UNIT

The SLE motor drive controller is an open chassis component for use in a suitable enclosure

Drives and process control systems are a very important part of creating better quality and value in the goods for our society, but they must be designed, installed and used with great care to ensure everyone's SAFETY.

Remember that the equipment you will be using incorporates...

High voltage electrical equipment

Powerful rotating machinery with large stored energy

Heavy components

... and your process may involve ...

Hazardous materials

Expensive equipment and facilities

Interactive components

Always use qualified personnel to design, construct and operate your systems and keep SAFETY as your primary concern.

Thorough personnel training is an important aid to SAFETY and productivity.

SAFETY awareness not only reduces the risk of accidents and injuries in your plant, but has a direct impact on improving product quality and costs.

If you have any doubts about the SAFETY of your system or process, consult an expert immediately. Do not proceed without doing so.

HEALTH AND SAFETY AT WORK

Electrical devices can constitute a safety hazard. It is the responsibility of the user to ensure the compliance of the installation with any acts or bylaws in force. Only skilled personnel should install and maintain this equipment after reading and understanding this instruction manual. If in doubt refer to the supplier



Note. The contents of this manual are believed accurate at the time of printing. The manufacturers, however, reserve the right to change the content and product specification without notice. No liability is accepted for omissions or errors. No liability is accepted for the installation or fitness for purpose or application of the SLE motor drive unit.

- 1) CORRECT OPERATION OF MAIN CONTACTOR
- 2) CORRECT SCALING OF SPEED AND CURRENT
- 3) ARMATURE WIRING FIELD WIRING
- 4) SPEED DEMAND OK, CURRENT DEMAND OK
- 5) RUN LINE, POWER ON/OFF
- 6) SAFETY PRECAUTIONS !

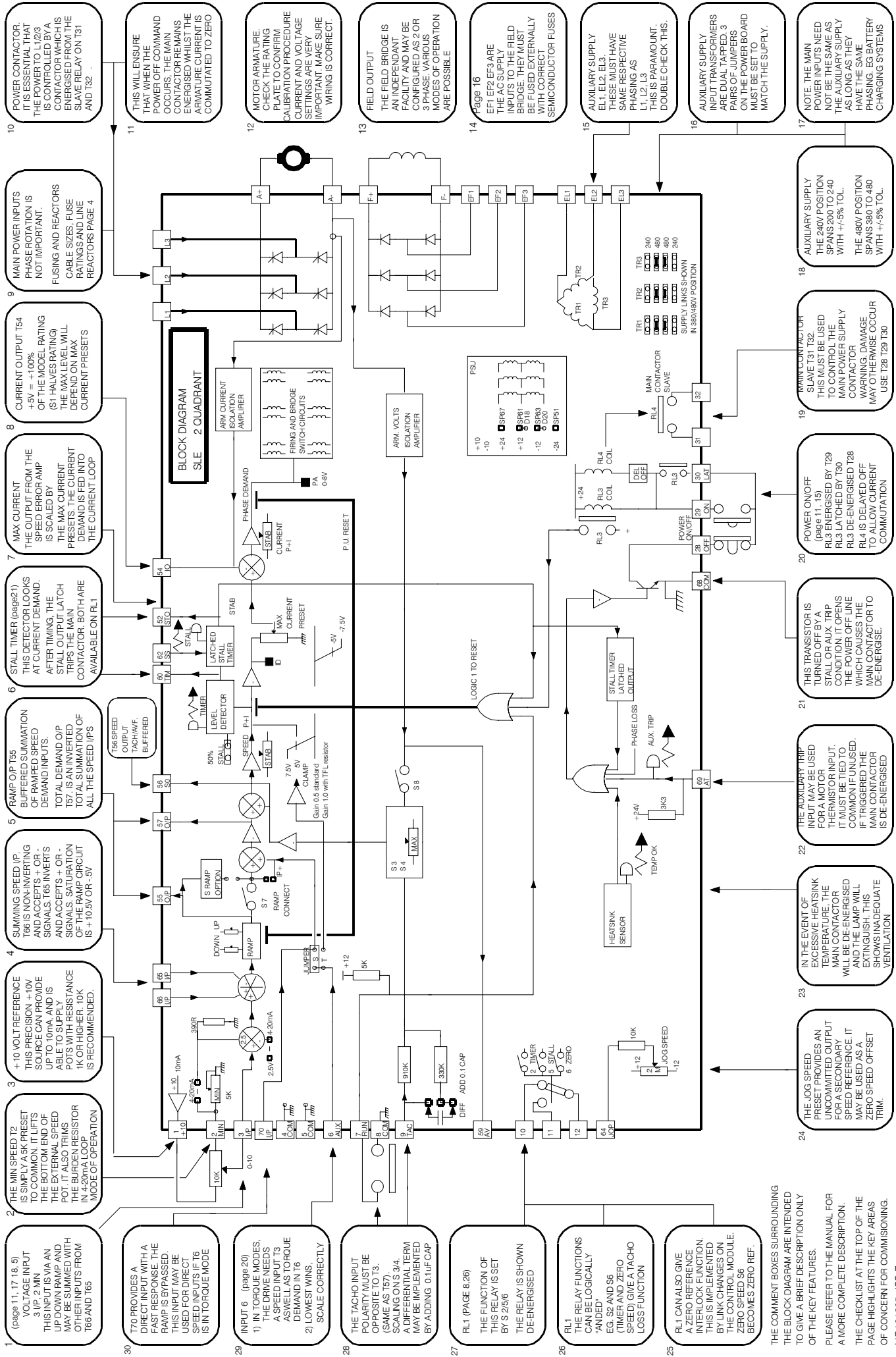

10 POWER CONTACTOR. IT IS ESSENTIAL THAT THE POWER TO L1/2/3 IS CONTROLLED BY A CONTACTOR WHICH IS ENERGISED FROM THE SLAVE RELAY ON T31 AND T32.

9 MAIN POWER INPUTS PHASE ROTATION IS NOT IMPORTANT. FUSING AND REACTORS CABLE SIZES, FUSE RATINGS AND LINE RATINGS ARE GIVEN ON REACTORS PAGE 4

8 CURRENT OUTPUT T64 +5V = +100% OF THE MODEL RATING (S1 HALVES RATING) THE MAX LEVEL WILL DEPEND ON MAX CURRENT PRESETS

7 MAX CURRENT THE OUTPUT FROM THE SPEED ERROR AMP IS SCALED BY THE MAX CURRENT PRESETS. THE CURRENT DEMAND IS FED INTO THE CURRENT LOOP

6 STALL TIMER (page 21) THIS DETECTOR LOOKS AT CURRENT DEMAND. AFTER TIMING, THE STALL OUTPUT LATCH TRIPS THE MAIN CONTACTOR. BOTH ARE AVAILABLE ON RL1

5 RAMP/O/P T65 BUFFERED SUMMATION OF RAMPED SPEED DEMAND INPUTS. TOTAL DEMAND O/P T65 IS AN INVERTED SIGNAL. SATURATION OF THE RAMP CIRCUIT IS +10.5V OR -5V

4 +10 VOLT REFERENCE THIS PRECISION +10V SOURCE CAN PROVIDE UP TO 10mA, AND IS ABLE TO SUPPLY POTS WITH RESISTANCE 1K OR HIGHER. 10K IS RECOMMENDED.

3 THE MIN SPEED T2 IS SIMPLY A PRESET POSITION. EITHER THE COMMON END OR THE EXTENSION SPEED POT. IT ALSO TRIPS THE BURDEN RESISTOR IN 4-20mA LOOP MODE OF OPERATION

2 T70 PROVIDES A DIRECT INPUT WITH A FAST RESPONSE. THE RAMP IS BYPASSED. THIS INPUT MAY BE USED FOR DIRECT SPEED INPUTS IF T6 IS IN TORQUE MODE

11 THIS WILL ENSURE THAT WHEN THE POWER OFF COMMAND OCCURS, THE MAIN CONTACTOR REMAINS ENERGISED WHILST THE ARMATURE CURRENT IS COMMUTATED TO ZERO

12 MOTOR ARMATURE. CHECK THE RATING. CALIBRATION PROCEDURE CURRENT AND VOLTAGE SETTINGS ARE VERY IMPORTANT. MAKE SURE WIRING IS CORRECT.

13 FIELD OUTPUT THE FIELD BRIDGE IS AN INDEPENDANT FACILITY AND MAY BE CONFIGURED AS 2 OR 3 PHASE VARIOUS MODES OF OPERATION ARE POSSIBLE

14 EF1 EF2 EF3 ARE THE AC SUPPLY INPUTS TO THE FIELD BRIDGE. THEY MUST BE FUSED EXTERNALLY WITH CORRECT SEMICONDUCTOR FUSES

15 AUXILIARY SUPPLY EL1, EL2, EL3. THESE MUST HAVE SAME RESPECTIVE PHASING AS L1, L2, L3. THIS IS PARAMOUNT. DOUBLE CHECK THIS.

16 AUXILIARY SUPPLY INPUT TRANSFORMERS ARE DUAL TAPPED. 3 PAIRS OF TAPERS ON THE POWER BOARD MUST BE SET TO MATCH THE SUPPLY.

17 NOTE THE MAIN POWER INPUTS NEED TO BE THE SAME AS THE MAIN SUPPLY AS LONG AS THEY HAVE THE SAME PHASING. EG BATTERY CHARGING SYSTEMS

18 AUXILIARY SUPPLY THE 240V POSITION SPANS 200 TO 240 WITH +/-5% TOL. THE 480V POSITION SPANS 360 TO 480 WITH +/-5% TOL.

19 MAIN CONTACTOR SLAVE T31 T32. THIS MUST BE USED TO CONTROL THE MAIN POWER SUPPLY CONTACTOR. WARNING. DAMAGE MAY OTHERWISE OCCUR USE T28 T29 T30

20 POWER ON/OFF (PAGE 18) RL3 ENERGISED BY T29. RL3 LATCHED BY T30. RL4 IS DELAYED OFF TO ALLOW CURRENT COMMUTATION

21 THIS TRANSISTOR IS DRIVEN OFF T19. STALL OR AUX TRIP CONDITION OPENS THE POWER OFF LINE WHICH CAUSES THE MAIN CONTACTOR TO DE-ENERGISE.

22 THE AUXILIARY TRIP INPUT MAY BE USED FOR A MOTOR THERMISTOR INPUT. IT MUST BE TIED TO COMMON IF UNUSED. AND THE LAMP WILL EXTINGUISH. THIS SHOWS INADEQUATE VENTILATION

23 IN THE EVENT OF EXCESSIVE HEAT SINK TEMPERATURE, THE MAIN CONTACTOR WILL BE DE-ENERGISED AND THE LAMP WILL EXTINGUISH. THIS SHOWS INADEQUATE VENTILATION

24 THE JOG SPEED PRESET PROVIDES AN OUTPUT FOR SPEED REFERENCE. IT MAY BE USED AS ZERO SPEED OFFSET TRIM.

25 RL1 CAN ALSO GIVE A ZERO REFERENCE INTERLOCK FUNCTION. THIS IS IMPLEMENTED BY LINK CHANGES ON THE CONTROL MODULE. ZERO SPEED S6 BECOMES ZERO REF.

26 THE RELAY FUNCTIONS CAN BE LOGICALLY AND'ED. EG. S2 AND S6 (TIMER AND ZERO SPEED) GIVE A TACHO LOSS FUNCTION

27 RL1 (PAGE 8, 26) THE FUNCTION OF THIS RELAY IS SET BY S 2/5/6. THE RELAY IS SHOWN DE-ENERGISED

28 THE TACHO INPUT POLARITY MUST BE OPPOSITE TO T3. (SAME AS T57). SCALING ON S 3/4. A DIFFERENTIAL TERM MAY BE IMPLEMENTED BY ADDING 0.1UF CAP

29 INPUT 6 (PAGE 20) 1) IN TORQUE MODES, THE DRIVE NEEDS A SPEED INPUT T3 AS WELL AS TORQUE DEMAND IN T6 2) LOWEST WINS. SCALE CORRECTLY

30 T70 PROVIDES A DIRECT INPUT WITH A FAST RESPONSE. THE RAMP IS BYPASSED. THIS INPUT MAY BE USED FOR DIRECT SPEED INPUTS IF T6 IS IN TORQUE MODE

31 BLOCK DIAGRAM SLE 2 QUADRANT

32 ARM CURRENT SENSING AMPLIFIER

33 FIRING AND BRIDGE SWITCH-CIRCUITS

34 ARM VOLTS ISOLATION AMPLIFIER

35 PSU

36 MAIN CONTACTOR

37 AUXILIARY CONTACTOR

38 SUPPLY LINKS SHOWN IN 380V/480V POSITION

THE COMMENT BOXES SURROUNDING THE BLOCK DIAGRAM ARE INTENDED TO GIVE A BRIEF DESCRIPTION ONLY OF THE KEY FEATURES. PLEASE REFER TO THE MANUAL FOR A MORE COMPLETE DESCRIPTION. THE CHECKLIST AT THE TOP OF THE PAGE HIGHLIGHTS THE KEY AREAS OF CONCERN FOR COMMISSIONING.

AC SUPPLY INPUT SEMICONDUCTOR FUSE TABLE FOR SLE DRIVES.

UL recognised fuses must be used in systems complying with UL codes.

MODEL	MAX I ² t OF FUSE	AC I/P AMPS	DC O/P AMPS	LITTLEFUSE		BUSS		(European)		IR American Style		IR BS88		FERRAZ		NOT UL UP TO 500V AC SUPPLY
				UP TO 250V AC SUPPLY	UP TO 500V AC SUPPLY	UP TO 250V AC SUPPLY	UP TO 500V AC SUPPLY	UP TO 250V AC SUPPLY	UP TO 500V AC SUPPLY	UP TO 250V AC SUPPLY	UP TO 500V AC SUPPLY	UP TO 250V AC SUPPLY	UP TO 500V AC SUPPLY	UP TO 250V AC SUPPLY	UP TO 500V AC SUPPLY	
SLE 14	600	27	34	L25S 35	L50S 35	FWX - 35A	FWH - 35A	170L1013	XL25X30	XL50F035	L350-32	661RF00 35	URE 32 N 81984	6,600 CP URD 22-58/32 Z 94828		
SLE 24	5000	46	58	L25S 60	L50S 60	FWX - 60A	FWH - 60A	170M1566	XL25X50	XL50F060	L350-63	661RF00 63	URGS 60 W 76655	6,600 CP URD 22-58/63 T 94823		
SLE 34	5000	66	82	L25S 80	L50S 80	FWX - 80A	FWH - 80A	170M1566	XL25X70	XL50F080	L350-80	661RF00 80	URGS 80 Z 85559	6,600 CP URD 22-58/80 A 94829		
SLE 44	11850	85	106	L25S 100	L50S 100	FWX - 100A	FWH - 100A	170M1567	XL25X70	XL50F100	L350-100	661RF00 100	URZ 100 Y 85558	6,600 CP URD 22-58/100 Y 94827		
AUX FUSE	50	3	2.5	L25S 3	L60S 3	FWX-3A	FWH-3A	FWH 5A14F	XL25X3	XL50F003	A350-3	B1000F3	A 060 URD 003 T131	6,600 CP URD 003 T131		

IN GENERAL THE AC SUPPLY CURRENT PER PHASE IS 0.8 TIMES THE DC OUTPUT CURRENT, AND THE FUSE RATING SHOULD BE APPROX. 1.25 TIMES THE INPUT CURRENT.

THE FUSES SPECIFIED IN THIS TABLE HAVE BEEN RATED TO INCLUDE THE 150% OVERLOAD CAPABILITY AND OPERATE UP TO 50C AMBIENT AT THE MAXIMUM DRIVE RATING. TO SELECT A FUSE AT OTHER RATINGS FOR EXAMPLE WHEN USING A MOTOR RATED AT A LOWER POWER THAN THE DRIVE UNIT OR OPERATING AT A REDUCED MAXIMUM CURRENT LIMIT SETTING. SELECT A FUSE WITH A CURRENT RATING CLOSEST TO THE ARMATURE CURRENT AND WITH AN I²t RATING LESS THAN THE MAXIMUM SHOWN IN THE TABLE.

European stock fuses and fuseholders

To optimise stock availability some fuses have higher than necessary current ratings but will still provide protection because the correct I²t rating is the prime factor.

Drive	Current	volts	AC fuse type	approx. dissipation for 3 main fuses at 100%	Main fuses and holders with covers		Auxiliary fuses and holders with covers	
					FUSE	HOLDER	FUSE	HOLDER
SLE14	34A	480	BUSS 170M1564	15 W	FUSE HOLDER 1 POLE 14 X 51 mm	SPRINT CH00740A CP102053	SPRINT CH00608A 6 X 32 CP102071	
SLE24 SLE34	58A 82A	480	BUSS 170M1566	35 W 50 W	FUSE HOLDER 1 POLE 00	SPRINT CH00880A CP102054	SPRINT CH00608A 6 X 32 CP102071	
SLE44	106A	480	BUSS 170M1567	70 W	FUSE HOLDER 1 POLE 00	SPRINT CH008100 CP102054	SPRINT CH00608A 6 X 32 CP102071	

LINE REACTOR DIMENSIONS

Note. Only use CSA certified line reactors for installations complying with CSA codes. These units are not CSA certified. Refer to supplier for full ratings of CSA certified alternatives.

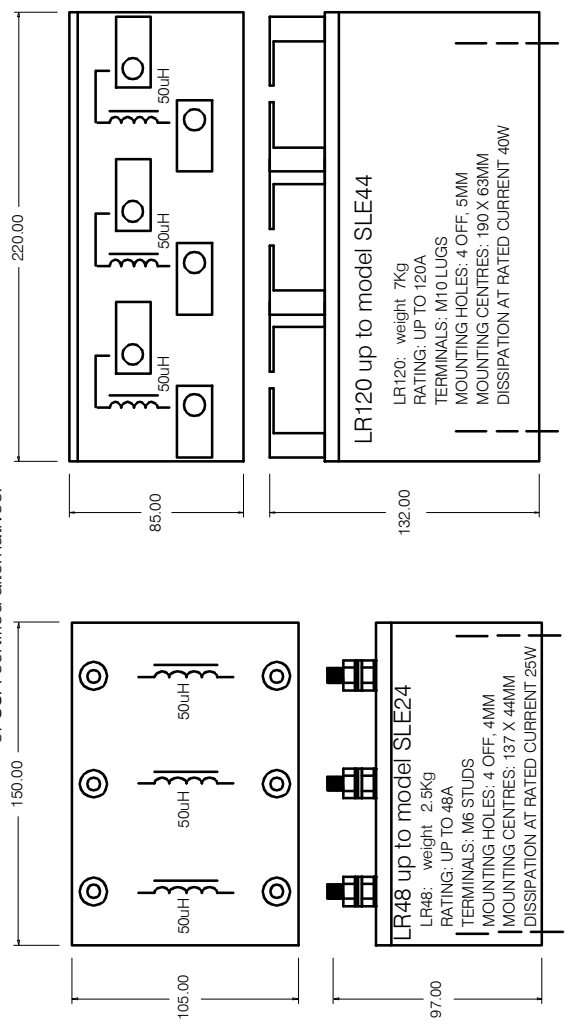

These application notes are strictly for assistance in the general implementation of Sprint products, and are provided for general guidance in system applications. It is entirely the users responsibility to ensure that any system is suitable for the application in question and all due care for is taken with regard to overall safety of the installation. Sprint Electric does not accept any liability in respect of the application.

Section 6

Application diagrams for model SLE

Page	Drg.	Application
1	1	Armature voltage feedback
	2	Tacho feedback
	3	Dynamic braking
	4	Torque control
2	1	Digital panel meters showing speed and current
	2	Utilising the down ramp when stopping
	3	Connection of auxiliary signal relays
	4	Using relay drivers for lamps
3	1	Interfacing with a PLC
	2	Control via open collector PLC outputs
	3	Remote setpoint, local min speed
	4	Local or remote speed demand selected by switch
4	1	Winding application using the 430 winder card
5	1	Master/slave speed follower
	2	Load sharing
6	1	Master setpoint to multiple drives using buffer card.
7	1	Linking drives together, one trips, all trip
	2	Power on interlock
	3	Motor thermistor
	4	Contactor in armature circuit
	5	Power on with maintained contact
8	1	Zero reference interlock
9	1	Reversing system
10	1	Simple dancing arm circuits
11	1	Jog speed summed with main reference
	2	Jog speed selected by switch
	3	Jogging on main contactor with main reference
	4	Jogging on main contactor with jog speed reference
12		Motor field circuits
	1	3 phase half wave field and economy mode
	2	2 phase field supply with delayed turn off
	3	Field energised by main contactor
13	1	MICRO ANALOG PROCESSOR
		Signal pad listing
14	1	Control circuit diagram
15	1	Power circuit diagram
16	1	Circuit board component layout
17	1	Local transformer power supplies Power supply condition
18	1	EMC installation guidelines
19	1	General 3 phase D. C. drives applications
20	1	General 3 phase D. C. drives applications

1) BASIC CONNECTION. ARMATURE VOLTAGE FEEDBACK

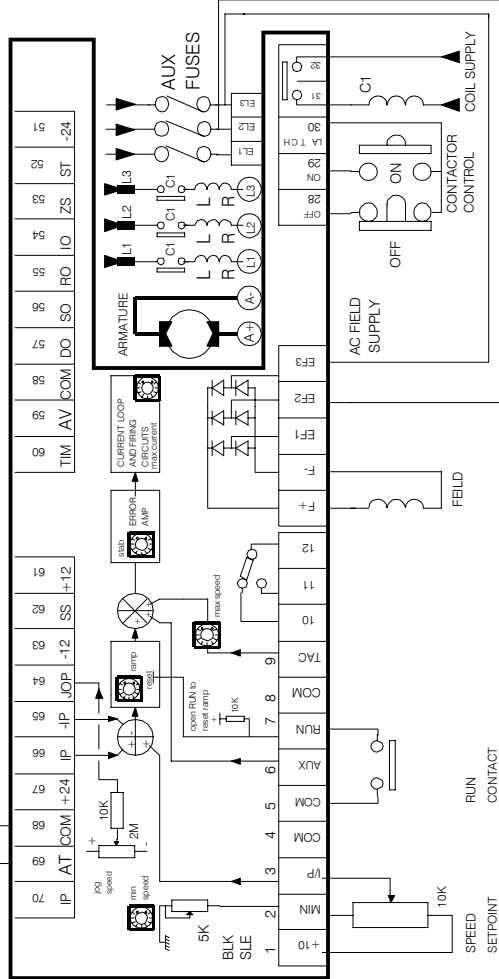

2) BASIC CONNECTION. TACHO FEEDBACK

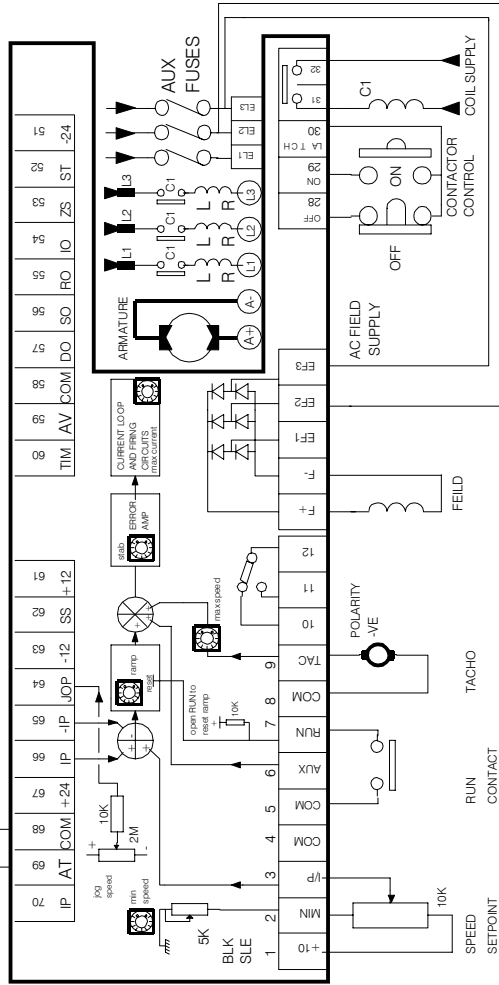

3) BASIC CONNECTION. DYNAMIC BRAKING

C1 normally open. C2 normally closed. The relays operate together. The peak braking current should not exceed 3 times the nominal armature current. The resistor must be able to dissipate the waste heat.

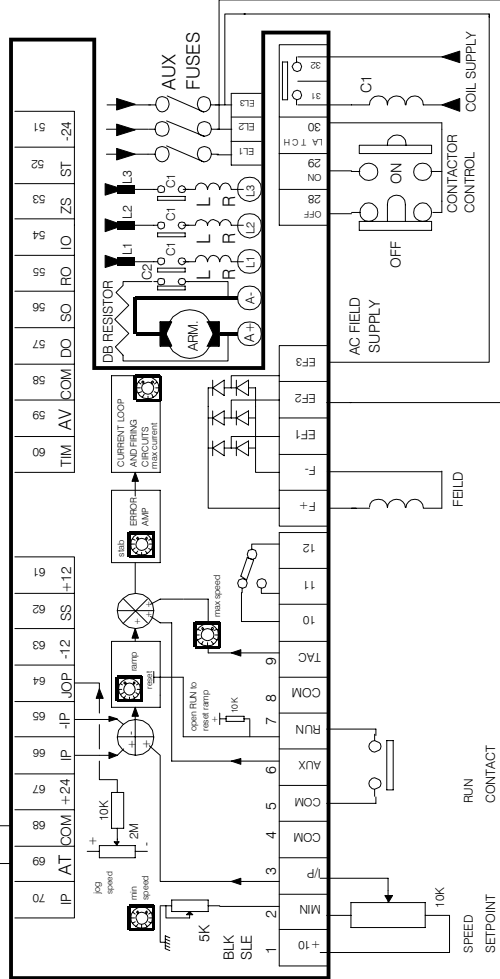

4) TORQUE CONTROL, OVERSPEED LIMITING BY SEPERATE SPEED SETPOINT

If the speed exceeds the level programmed by the speed setpoint, then the current demand comes out of limit and the speed loop takes control.

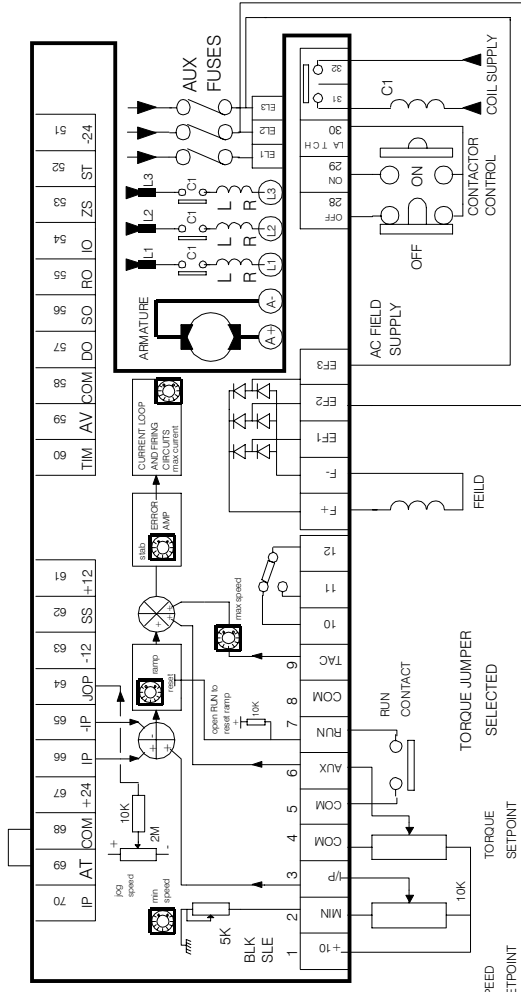

1) DIGITAL PANEL METERS TYPE 355 USED TO SHOW SPEED AND CURRENT

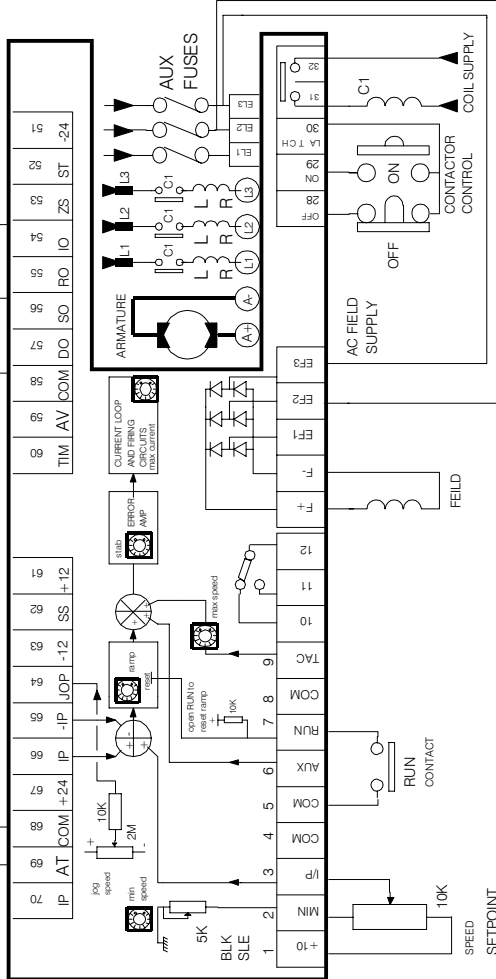

2) OPENING THE RUN CONTACT CAUSES THE DRIVE TO COAST TO REST AND RESETS THE SETPOINT RAMP. OPENING SW1 CAUSES THE SETPOINT RAMP OUTPUT TO GO TO ZERO AT THE RATE SET ON THE DOWN RAMP PRESET. THE MOTOR WILL FOLLOW THE DOWN RAMP PROVIDING THE COAST DOWN RATE IS FASTER.

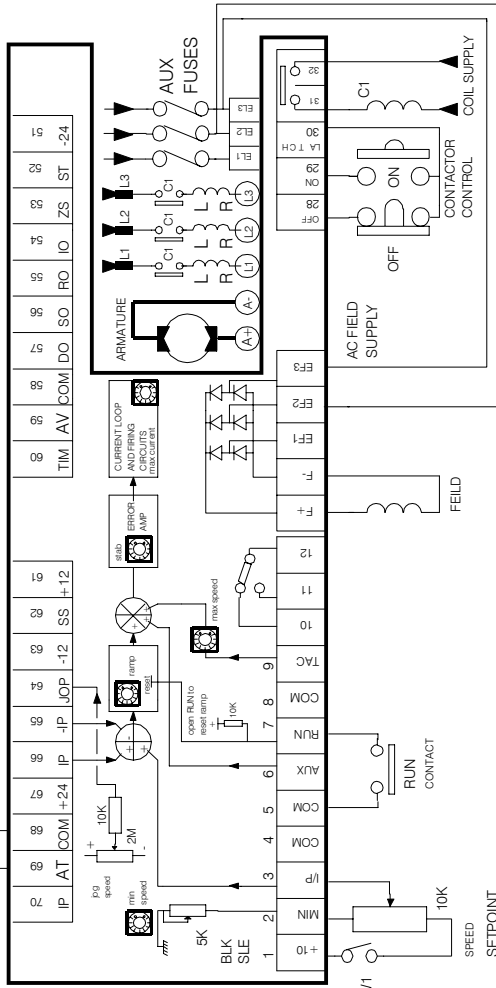

3) CONNECTION OF AUXILIARY SIGNAL RELAY, minimum coil resistance 1k. STALL, ZERO and TIMER functions available on terminals 52/53 and 60. They are also switch selectable functions for the on board relay

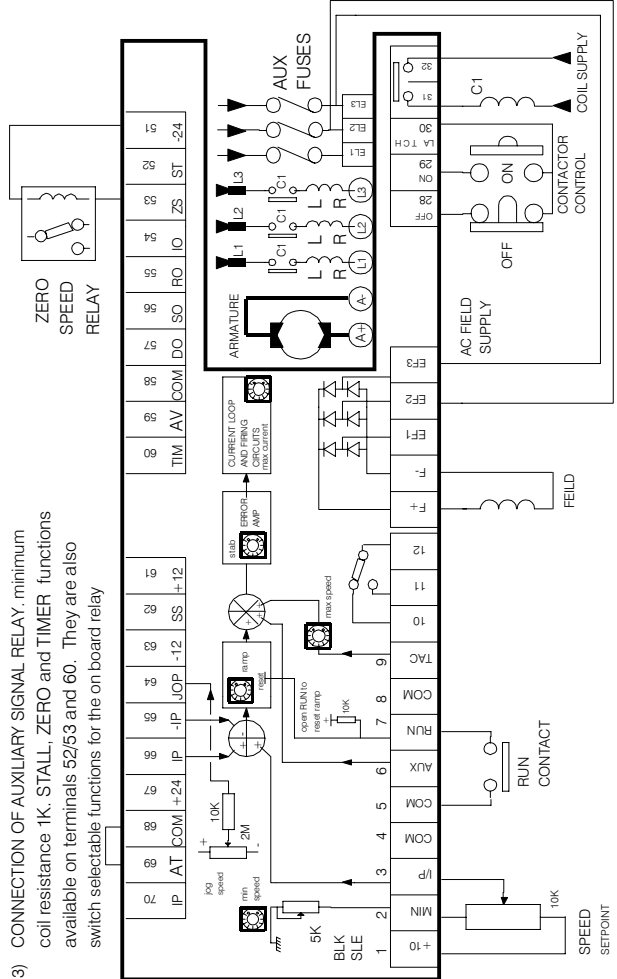

4) USING RELAY DRIVERS FOR LAMPS. The relay drivers may also drive various types of indicators. Shown here are 3 types. The lamps must be 24V/25mA types. Max. total 25mA.

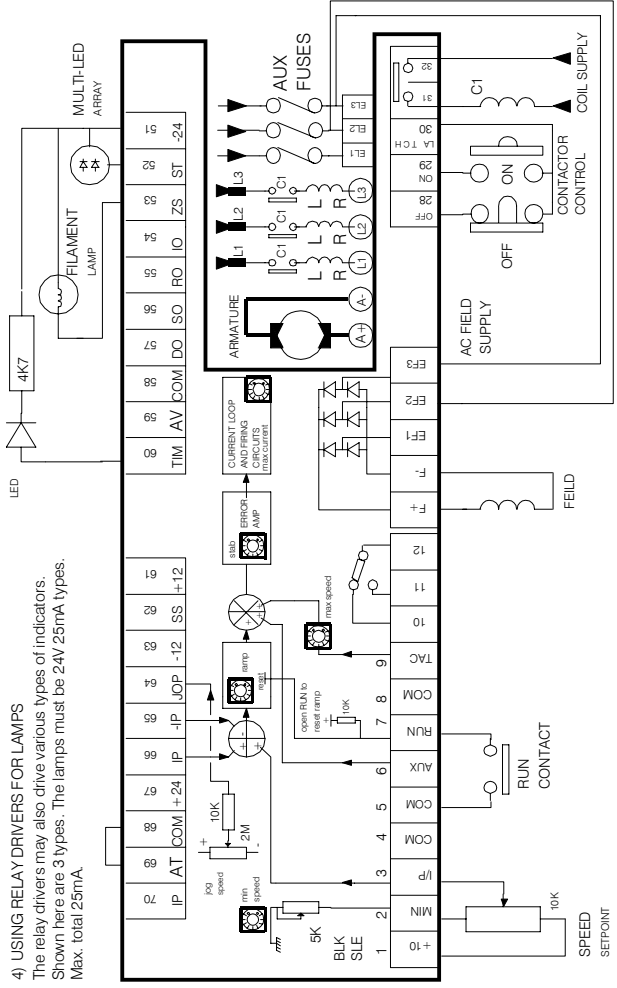

1) INTERFACING WITH A PLC

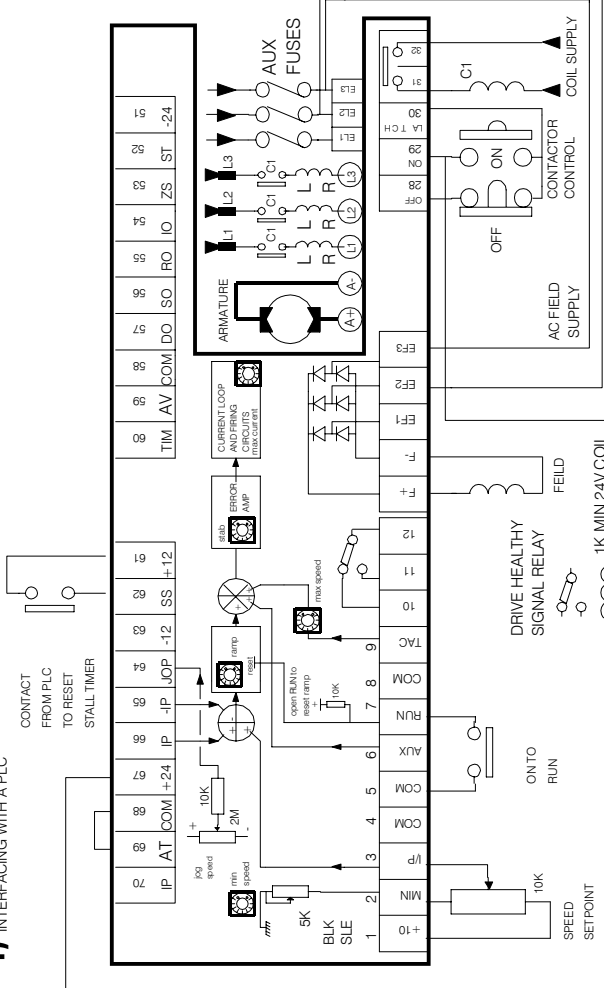

2) CONTROL VIA OPEN COLLECTOR PLC OUTPUTS.

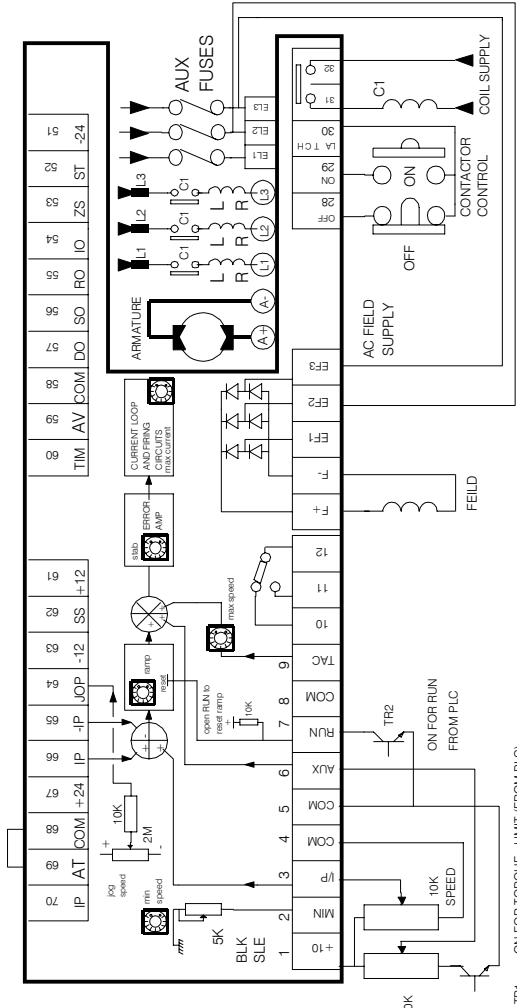

3) THE DRIVE SPEED IS SET BY A REMOTE 0 TO +10 VOLT SIGNAL. THE DRIVE ZERO IS LOCALLY TRIMMED BY SUMMING THE JOG OUTPUT REFERENCE INTO T66. THE MAXIMUM SPEED WILL BE THE SUM OF THE REMOTE AND ZERO SIGNAL. THE TOTAL IS LIMITED TO 10.5VOLTS INTERNALLY

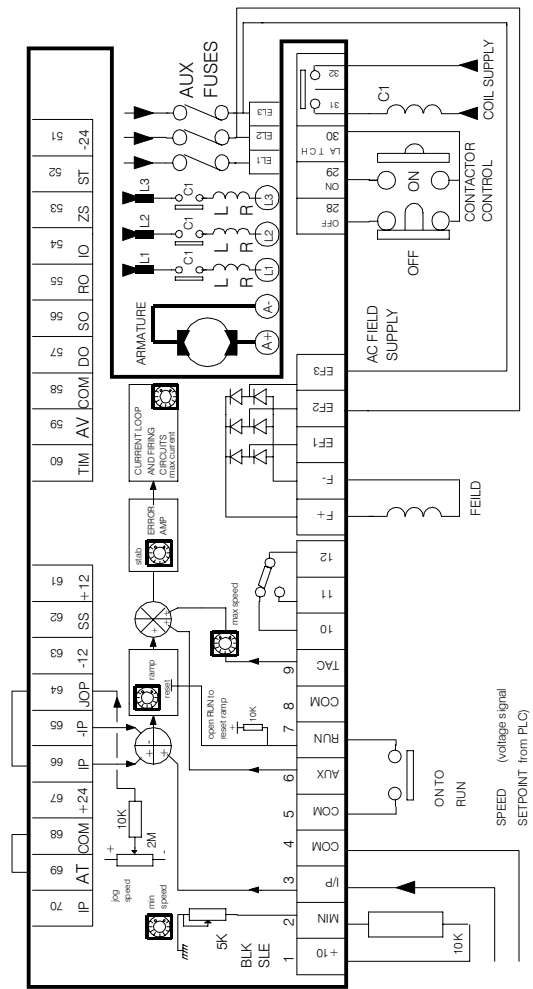

4) LOCAL OR REMOTE SPEED DEMAND SELECTED BY SWITCH. THE DRIVE WILL RAMP BETWEEN THE SETPOINTS WHEN SWITCHED.

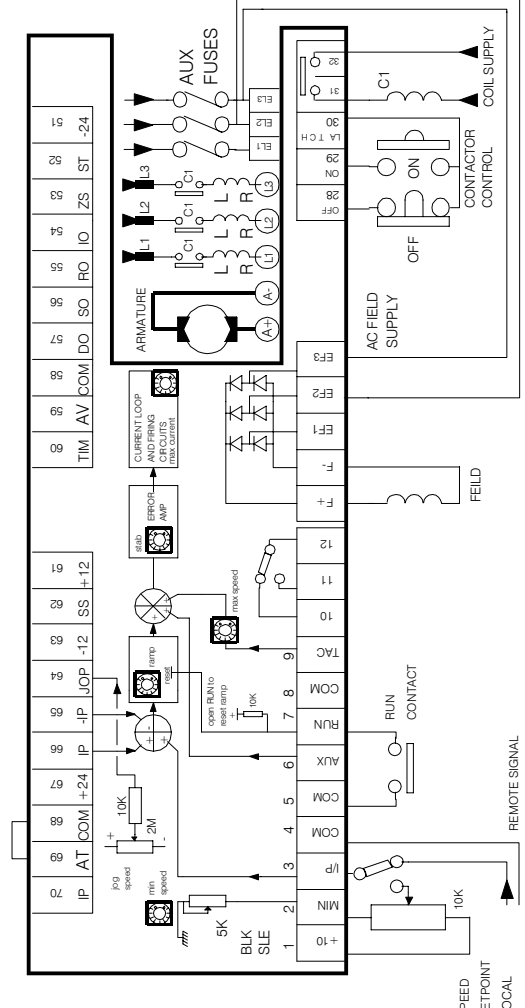

WEB DRIVE IN SPEED MODE

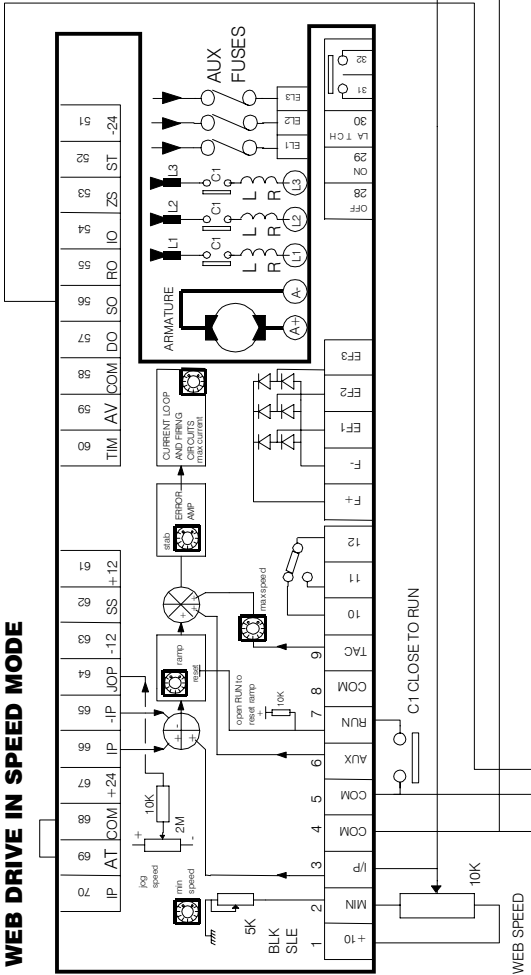

REEL DRIVE IN TORQUE MODE

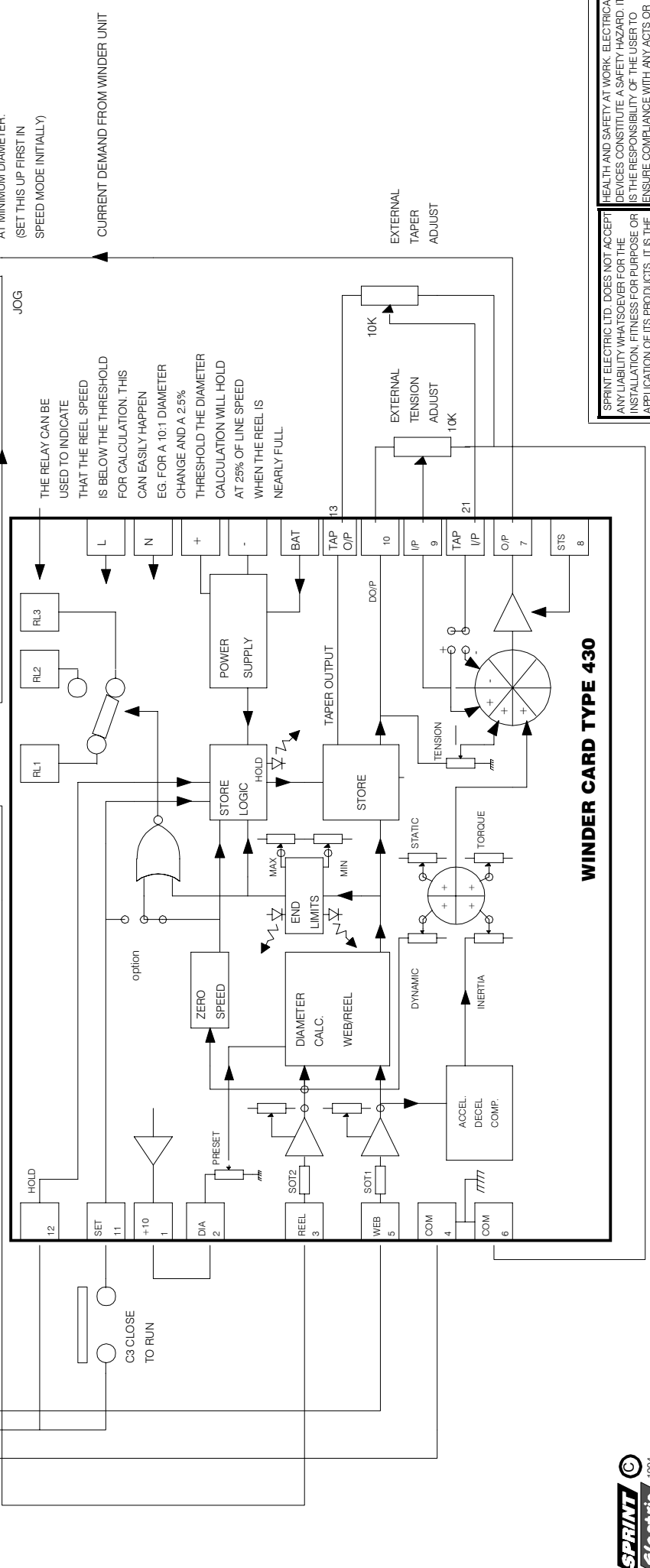
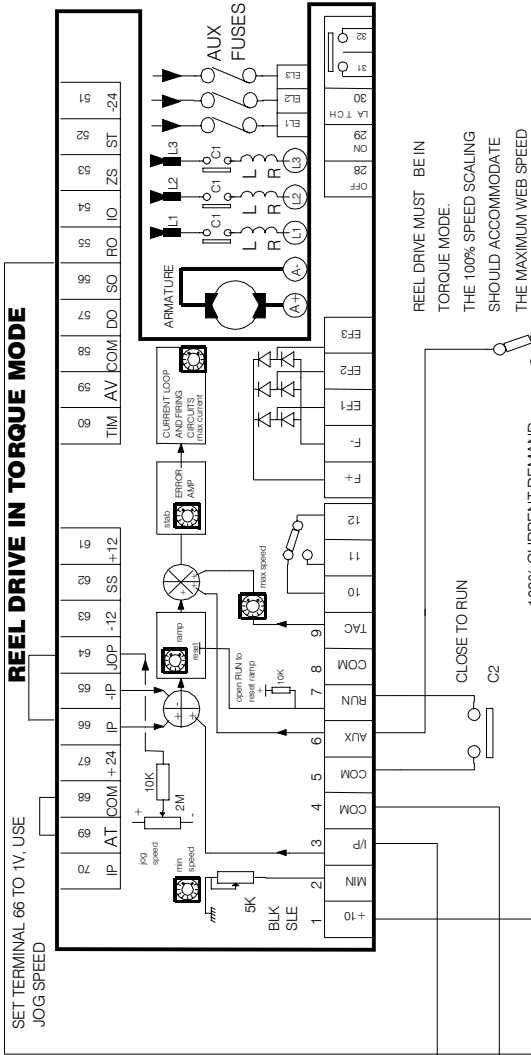

REEL DRIVE MUST BE IN TORQUE MODE. THE 100% SPEED SCALING SHOULD ACCOMMODATE THE MAXIMUM WEB SPEED AT MINIMUM DIAMETER. (SET THIS UP FIRST IN SPEED MODE INITIALLY)

THE RELAY CAN BE USED TO INDICATE THAT THE REEL SPEED IS BELOW THE THRESHOLD FOR CALCULATION. THIS CAN EASILY HAPPEN CHANGE AND A 2.5% THRESHOLD THE DIAMETER CALCULATION WILL HOLD AT 25% OF LINE SPEED WHEN THE REEL IS NEARLY FULL

WEB SPEED
C1 CLOSE TO RUN
C2 CLOSE TO RUN
100% CURRENT DEMAND
JOG
CURRENT DEMAND FROM WINDER UNIT

EXTERNAL TAPER ADJUST

EXTERNAL TENSION ADJUST

WINDER CARD TYPE 430

WINDER APPLICATION. MODEL SLE

SPRINT ELECTRIC LTD. DOES NOT ACCEPT ANY LIABILITY WHATSOEVER FOR THE INSTALLATION, FITNESS FOR PURPOSE OR APPLICATION OF ITS PRODUCTS. IT IS THE USER'S RESPONSIBILITY TO ENSURE THE BYLAWS IN FORCE. ONLY SKILLED PERSONS SHOULD BE ALLOWED TO INSTALL AND MAINTAIN THIS EQUIPMENT.

1) MASTER DRIVE WITH SLAVE FOLLOWING IN SPEED MODE

THE SPEED DEMAND FOR THE SLAVE CAN BE SELECTED TO BE THE RAMP OUTPUT FROM THE MASTER. THE DRIVES ARE SHOWN USING ONLY ONE MASTER POWER ON PUSHBUTTON AND INDIVIDUAL POWER OFF PUSHBUTTONS.

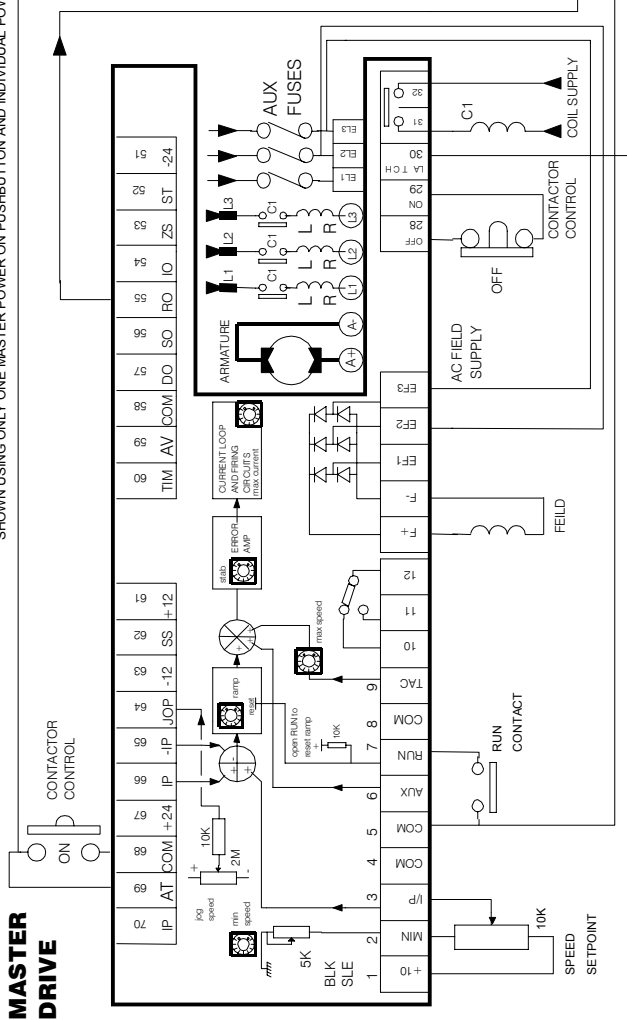

SLAVE FOLLOWER OR A LOCAL POT.

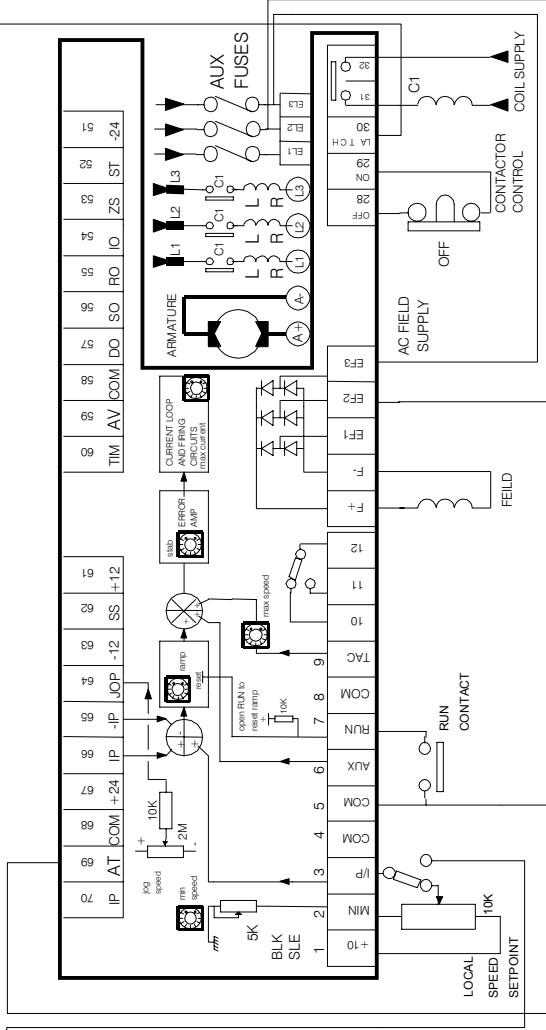

2) LOAD SHARING. THE CURRENT SIGNAL FROM THE MASTER PROVIDES A TORQUE DEMAND INPUT TO THE SLAVE.

Make speed scaling of both drives matched then adjust JOG SPEED preset to give -1V on terminal 65.

Insert a resistor value < 1Kohm in the TFL position on the slave to rescale the 100% torque demand level to 5V. The slave must be in TORQUE mode.

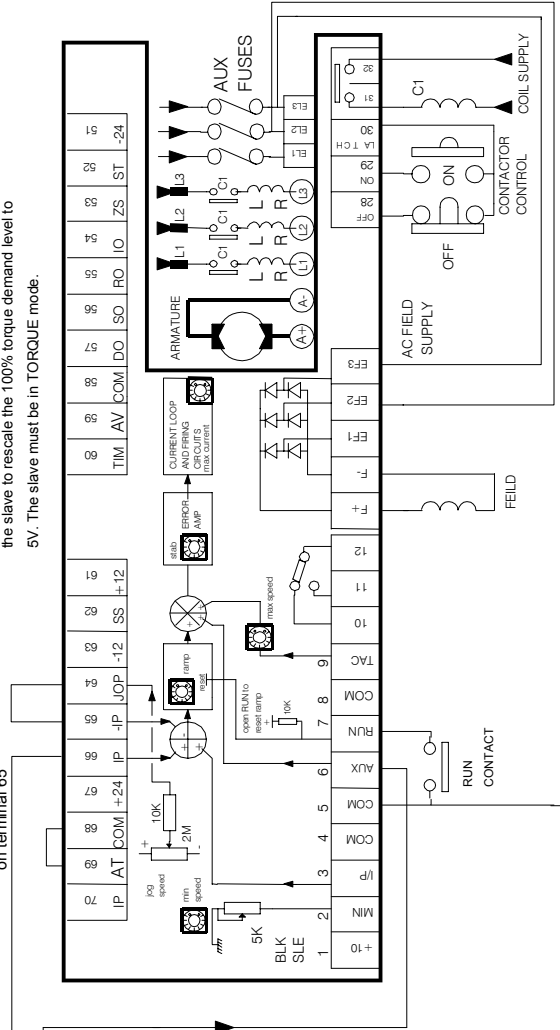
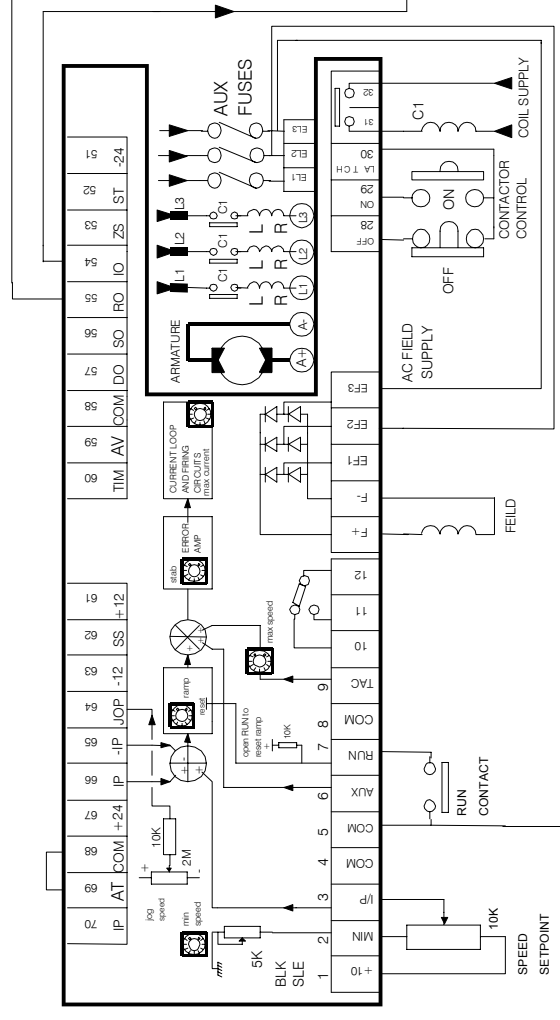

1 METHOD FOR ENABLING POWER ON FOR MULTIPLE DRIVES WITH ONE SET OF POWER OFF / POWER OFF PUSHBUTTONS. INITIALLY THE DRIVES WILL BE IN THE AUX. TRIP CONDITION. THE POWER ON BUTTON ENABLES DRIVE 'A' WHICH LATCHES THROUGH ITS POWER OFF BUTTON CAUSING TERMINAL 30 TO GO LOW. THIS SEQUENCE RIPPLES ROUND THE RING WITH DRIVE 'D' LATCHING 'A'. EACH DRIVE MAY HAVE ITS OWN POWER OFF BUTTON WHICH TURNS OFF THE WHOLE RING. THE PROPAGATION DELAY IS ABOUT 25ms PER DRIVE.

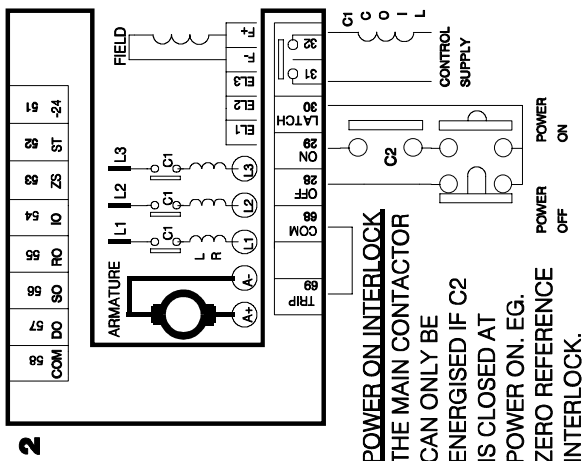
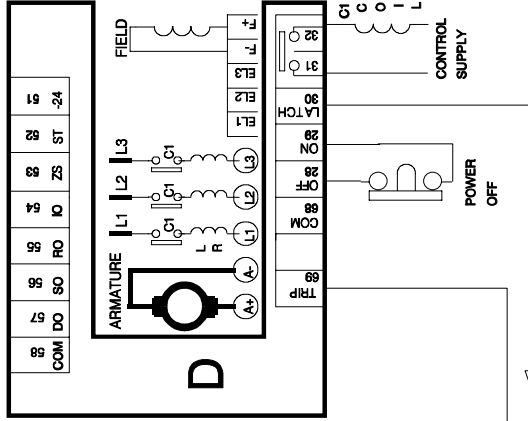
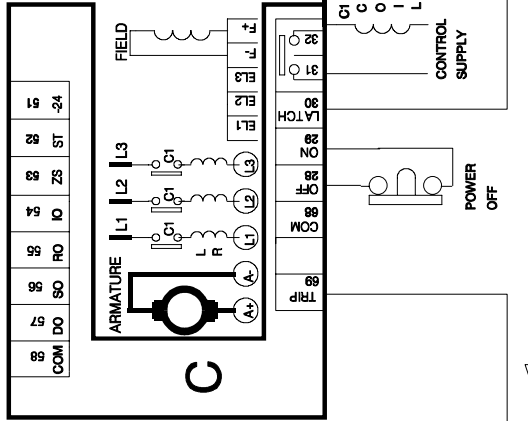
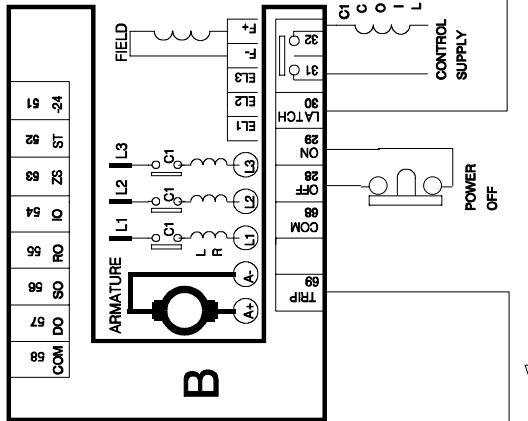
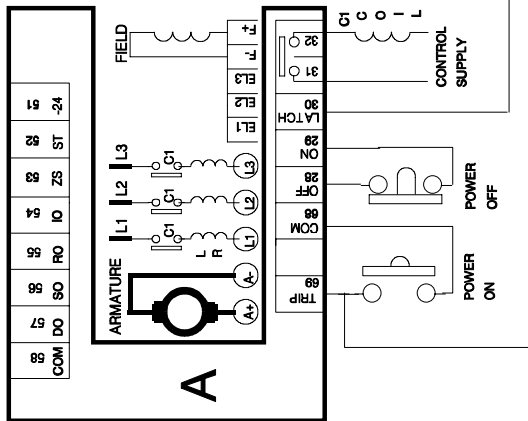

POWER ON INTERLOCK
THE MAIN CONTACTOR CAN ONLY BE ENERGISED IF C2 IS CLOSED AT POWER ON. EG. ZERO REFERENCE INTERLOCK.

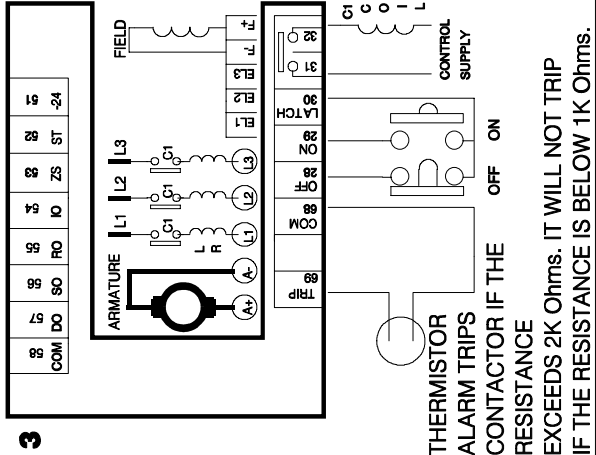

THERMISTOR ALARM TRIPS CONTACTOR IF THE RESISTANCE EXCEEDS 2K Ohms. IT WILL NOT TRIP IF THE RESISTANCE IS BELOW 1K Ohms.

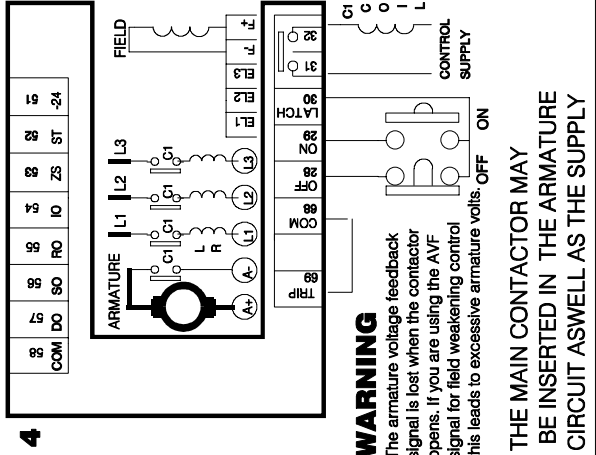

WARNING
The armature voltage feedback signal is lost when the contactor opens. If you are using the AVF signal for field weakening control this leads to excessive armature volts.

THE MAIN CONTACTOR MAY BE INSERTED IN THE ARMATURE CIRCUIT AS WELL AS THE SUPPLY

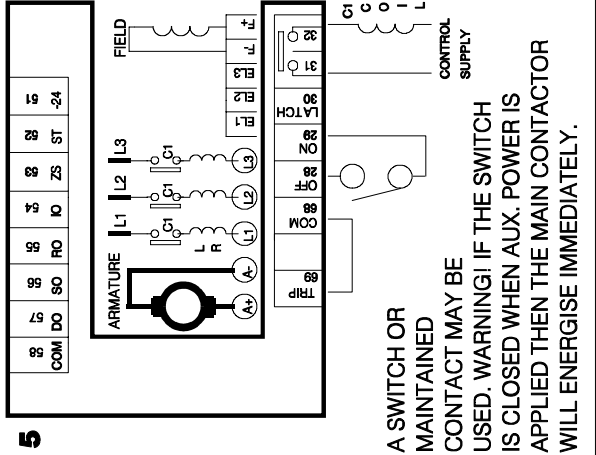

A SWITCH OR MAINTAINED CONTACT MAY BE USED. WARNING! IF THE SWITCH IS CLOSED WHEN AUX. POWER IS APPLIED THEN THE MAIN CONTACTOR WILL ENERGISE IMMEDIATELY.

- 1) Linking Drives together, one trips, all trip.
- 2) Power On interlock.
- 3) Thermistor

- 4) Contactor in Armature circuit.
- 5) Power On with maintained contact.

SPRINT ELECTRIC LTD. DOES NOT ACCEPT ANY LIABILITY WHATSOEVER FOR THE INSTALLATION FITNESS FOR PURPOSE OR APPLICATION OF ITS PRODUCTS. IT IS THE USER'S RESPONSIBILITY TO ENSURE THE UNIT IS CORRECTLY USED AND INSTALLED.

HEALTH AND SAFETY AT WORK ELECTRICAL DEVICES CONSTITUTE A SAFETY HAZARD. IT IS THE RESPONSIBILITY OF THE USER TO ENSURE COMPLIANCE WITH ANY ACTS OR BYLAWS IN FORCE. ONLY SKILLED PERSONS SHOULD INSTALL THIS EQUIPMENT.

ZERO REFERENCE INTERLOCK

A common requirement to prevent drive enable on turn on if the setpoint reference is not at zero. Provision has been made on the MICRO ANALOG PROCESSOR to have this feature selectable.

The SLE is provided with a zero speed function. A link on the PROCESSOR is remade and the zero speed detector becomes a zero reference detector.

A layout of the MICRO ANALOG PROCESSOR is shown below. (Located on the left hand side of the unit).

To implement the zero reference function the S link must be opened and the R link made. The links are made by solder bridges. Take great care not to damage the tracks when removing the solder.

The R link is normally open

The S link is normally made for the speed function.

Once the link has been altered it can be tested by selecting the zero speed relay function (SW1.6) and then applying a setpoint to terminal 3. The relay output should change state at 0.5V. The relay will be energised for voltages > than 0.5V.

71	RCO	-IP	81
72	TCI	OFS	82
73	IO	IP3	83
74	RUN	RIA	84
75	TDO	RST	85
76	DO	RO	86
77	DIP	SO	87
78	+10	COM	88
79	-24	+12	89
80	+24	-12	90

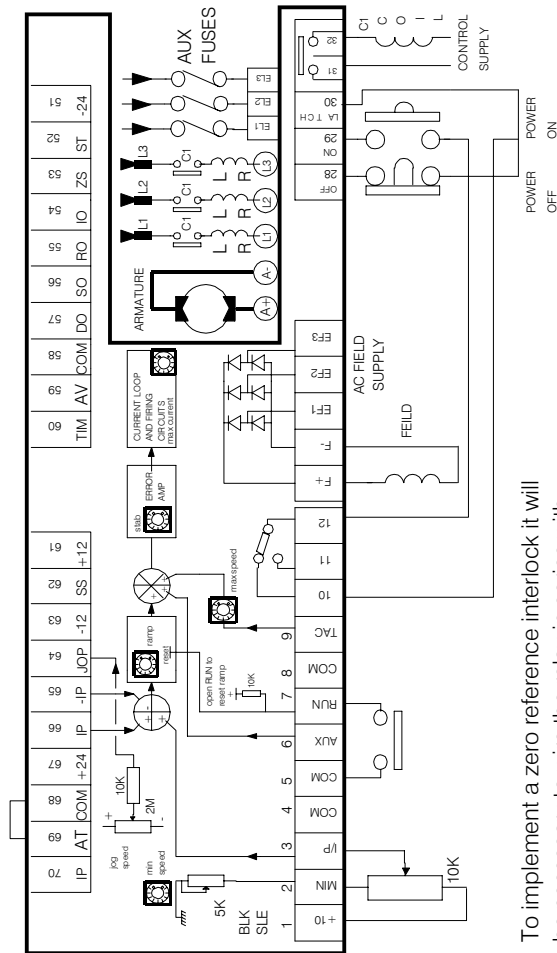

To implement a zero reference interlock it will be necessary to wire the relay in series with the POWER ON pushbutton as shown.

If this function is implemented by the user, please add a label to indicate the change.

**MODEL SLE
ARMATURE REVERSING WITH
ZERO SPEED INTERLOCK AND
DYNAMIC BRAKING**

Provision has been made on the MICRO ANALOG PROCESSOR to enable precision rectification of the speed feedback signal. A link on the PROCESSOR is desoldered and the tacho amplifier will accept positive or negative tacho feedback signals.

If the armature voltage feedback mode is required then no changes need to be made.

If tacho feedback mode is required and the link broken, then it is normally acceptable to revert to armature voltage feedback without remarking the link.

Please identify any changes with an appropriate label.

A layout of the MICRO ANALOG PROCESSOR is shown below. (Located on the left hand side of the unit).

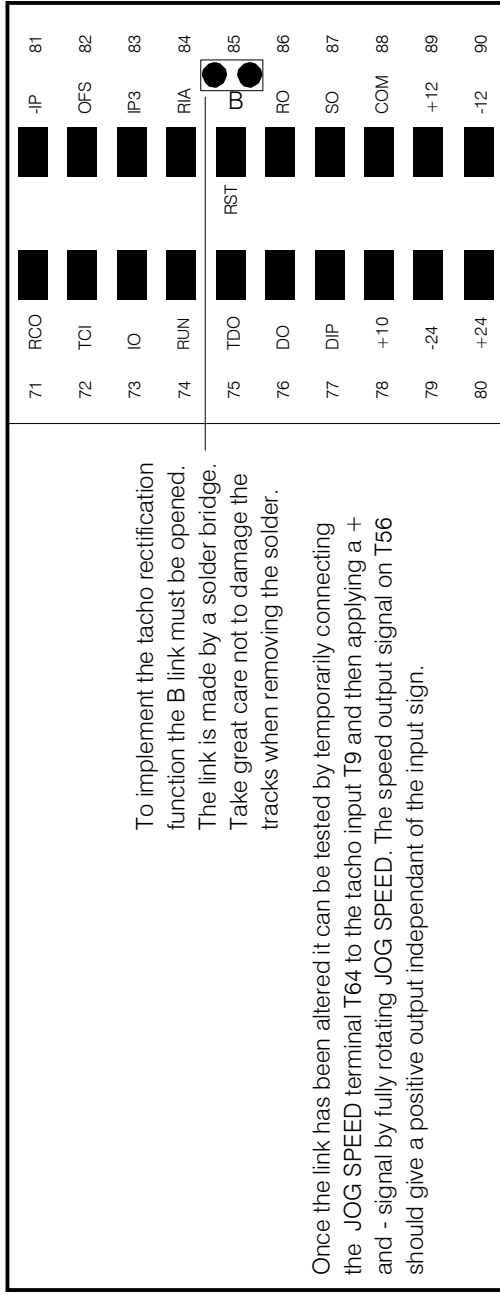

To implement the tacho rectification function the B link must be opened. The link is made by a solder bridge. Take great care not to damage the tracks when removing the solder.

Once the link has been altered it can be tested by temporarily connecting the JOG SPEED terminal T64 to the tacho input T9 and then applying a + and - signal by fully rotating JOG SPEED. The speed output signal on T56 should give a positive output independent of the input sign.

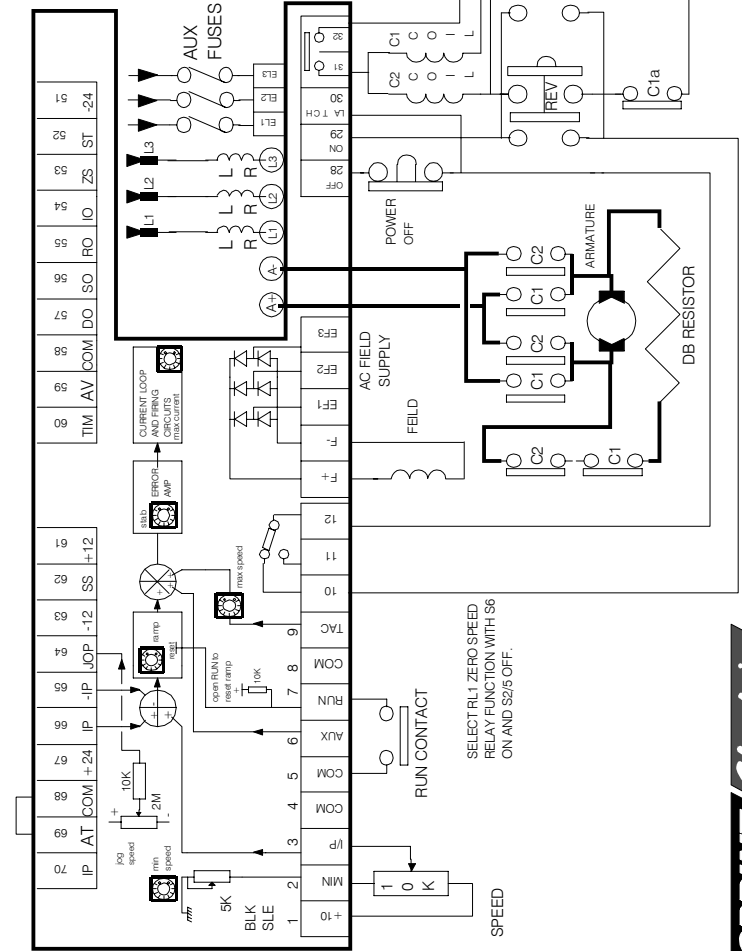

MODE OF OPERATION

- 1) C1 and C2 are initially de-energised
- 2) When FWD is selected, the aux FWD contact and the zero speed relay enable the drive slave and contact on T31/32 to latch on, energising the C1 coil via aux C2a.
- 3) The C1 coil latches itself on via C1b and the motor rotates forward with the DB resistor off. The REV function is disabled via aux C1a
- 4) When power off is selected, the drive slave contact on T31/32 opens, C1 de-energises and the DB resistor is connected across the armature.
- 5) The REV function cannot be selected until the zero speed relay de-energises at a speed <5% a similar fashion.
- 6) The sequence is repeated for REVERSE in a similar fashion.
- 7) If AV feedback is used it may be necessary to put a 47K 5W resistor across A+ - A- to ensure the correct operation of the internal zero detector.

**SPRINT ELECTRIC STOCK
A HIGH POWER DYNAMIC
BRAKING RESISTOR ASSEMBLY.**
Please refer to supplier

SPRINT ELECTRIC LTD. DOES NOT ACCEPT ANY LIABILITY WHATSOEVER FOR THE INSTALLATION, FITNESS FOR PURPOSE OR APPLICATION OF ITS PRODUCTS. IT IS THE USER'S RESPONSIBILITY TO ENSURE THE PRODUCTS ARE USED IN ACCORDANCE WITH THE INSTRUCTIONS AND SAFETY INFORMATION PROVIDED WITH THE EQUIPMENT.

HEALTH AND SAFETY AT WORK. ELECTRICAL DEVICES CONSTITUTE A SAFETY HAZARD. IT IS THE RESPONSIBILITY OF THE USER TO ENSURE COMPLIANCE WITH ANY ACTS OR REGULATIONS IN FORCE. ONLY SKILLED PERSONS SHOULD INSTALL THIS EQUIPMENT.



APPLICATION UTILISING DANCING ARM
 THE CONTROL SYSTEM IS DESIGNED TO GIVE PROPORTIONAL CLOSED LOOP CONTROL OF THE POSITION OF THE DANCING ARM
 THE POSITIVE SETPOINT RAMP OUTPUT AND THE NEGATIVE SETPOINT OUTPUT ARE APPLIED ACROSS THE SENSOR POT. THIS GIVES A SENSOR POT STRENGTH PROPORTIONAL TO LINE SPEED.

THE CENTRE ZERO POT AND BALLAST RESISTOR ALLOW ADJUSTMENT OF THE NULL POSITION BY +/-50% OF THE SENSOR POT TRAVEL. THEY CAN BE OMITTED IF THIS FUNCTION IS NOT WANTED
 THE GAIN POT ALLOWS ADJUSTMENT OF THE SENSOR POT SIGNAL STRENGTH BY 50% TO ALLOW STABILITY ADJUSTMENT AND/OR GAIN CONTROL. HIGHER GAIN GIVES TIGHTER CONTROL BUT LESS STABILITY.

IF THE ARM STARTS TO RISE THE DRIVE RECEIVES A +VE SIGNAL INTO THE INVERTING I/P, THIS GIVES A SPEED REDUCTION, WHICH CAUSES THE ARM TO RETURN TO THE NULL POSITION. A DROPPING ARM GIVES A SPEED INCREASE.

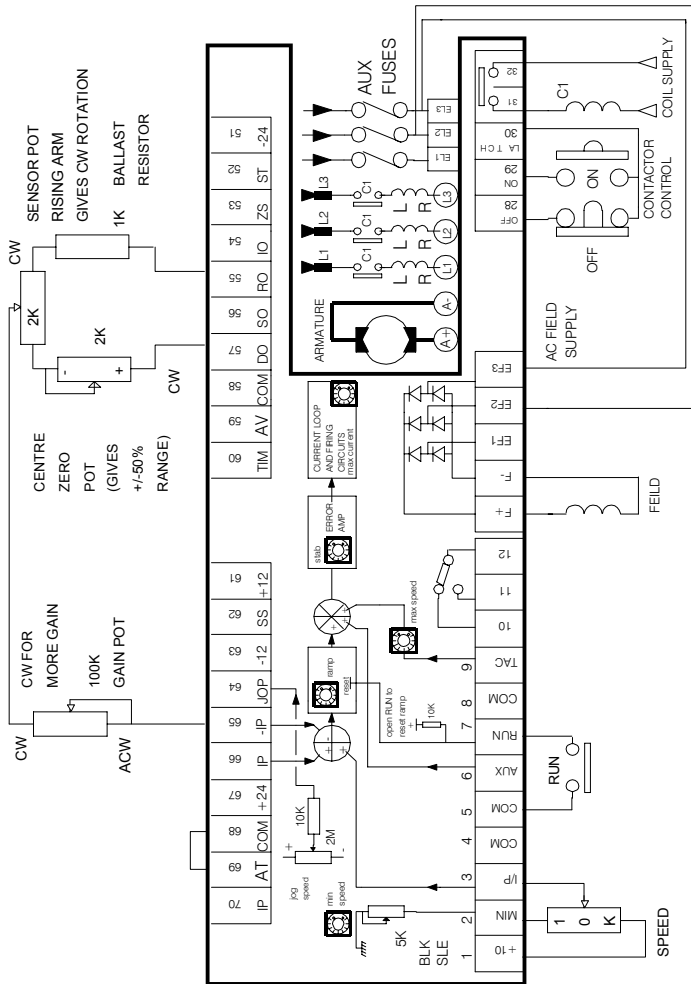
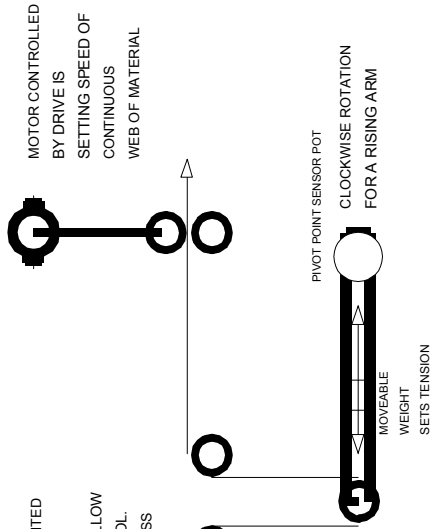

APPLICATION WHERE DANCING ARM POSITION IS CONTROLLED BY INPUT SPEED CHANGE.

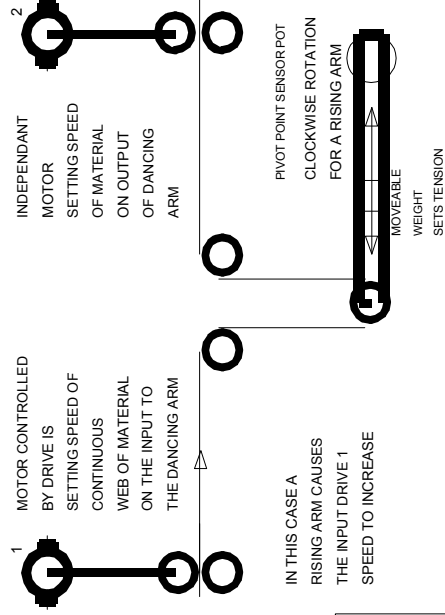

1 MOTOR CONTROLLED BY DRIVE IS SETTING SPEED OF CONTINUOUS WEB OF MATERIAL ON THE INPUT TO THE DANCING ARM

IN THIS CASE A RISING ARM CAUSES THE INPUT DRIVE 1 SPEED TO INCREASE

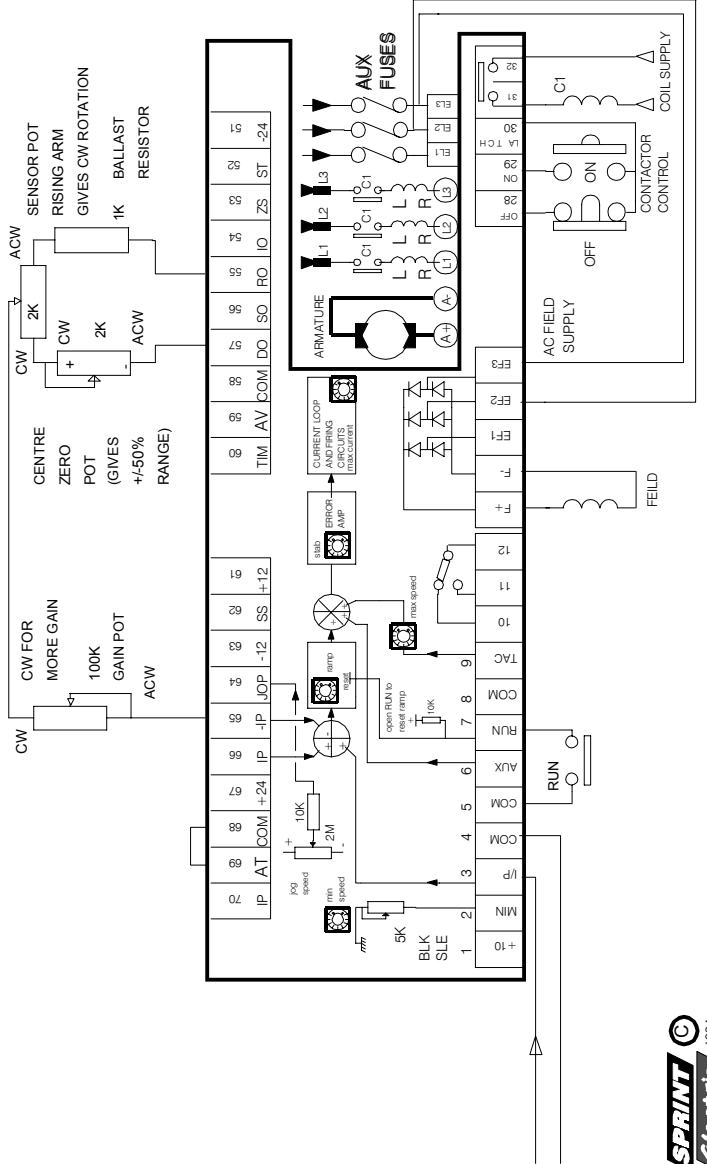

0 TO +10V SPEED REF. SIGNAL
 TAKEN FROM THE OUTPUT DRIVE 2. (EG. SCALED TACH SIGNAL OR RAMP O/P SIGNAL)

HEALTH AND SAFETY AT WORK. ELECTRICAL DEVICES CONSTITUTE A SAFETY HAZARD. IT IS THE RESPONSIBILITY OF THE USER TO ENSURE COMPLIANCE WITH ANY ACTS OR BYLAWS IN FORCE. ONLY SKILLED PERSONS SHOULD BE PERMITTED TO USE ELECTRICAL DEVICES.

1)

IF MOMENTARILY PRESSED, THE JOG BUTTON WILL RELEASE THE JOG SPEED REFERENCE WHICH WILL BE SUMMED WITH THE MAIN SPEED REFERENCE.

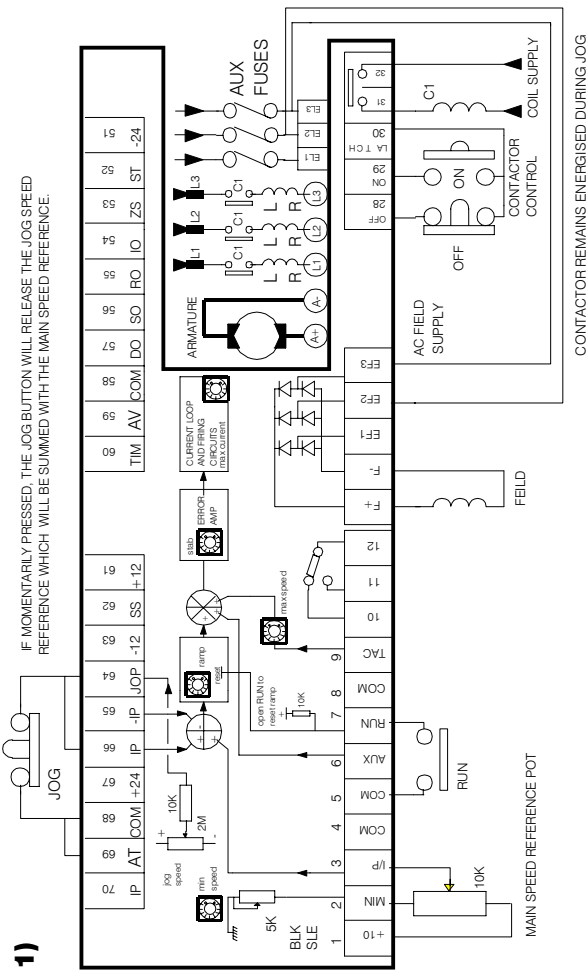

CONTACTOR REMAINS ENERGISED DURING JOG

3)

JOGGING ON MAIN CONTACTOR

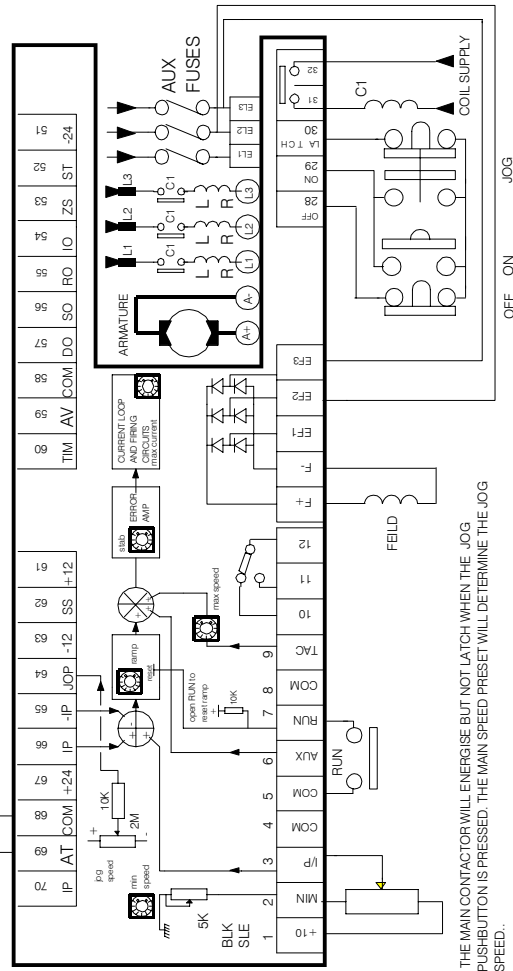

THE MAIN CONTACTOR WILL ENERGISE BUT NOT LATCH WHEN THE JOG PUSHBUTTON IS PRESSED. THE MAIN SPEED PRESET WILL DETERMINE THE JOG SPEED.

OFF ON JOG

2)

IF MOMENTARILY PRESSED, THE JOG BUTTON WILL RELEASE THE JOG SPEED REFERENCE WHICH WILL BE INPUT TO THE DRIVE IF THE JOG SWITCH HAS BEEN SET TO THE JOG POSITION. THE MAIN SPEED REFERENCE WILL BE INOPERATIVE.

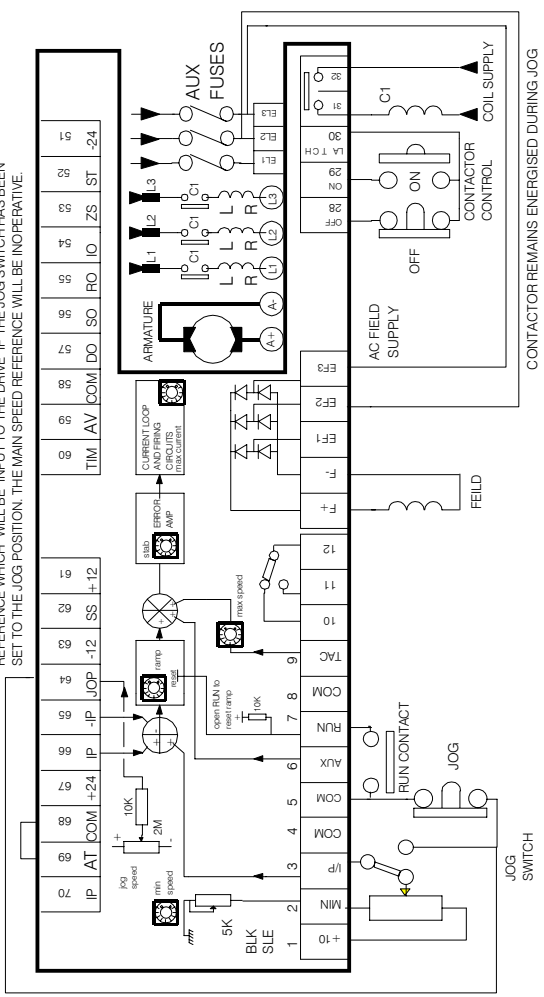

CONTACTOR REMAINS ENERGISED DURING JOG

4)

JOGGING ON MAIN CONTACTOR WITH AUTOMATIC JOG SPEED SELECTION BY EXTERNAL RELAY

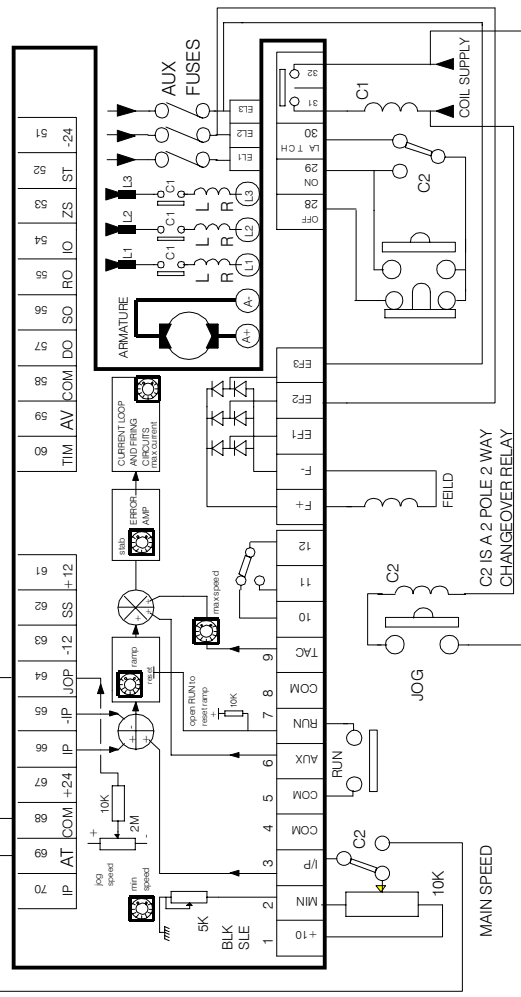

WHEN JOG IS PRESSED THE CONTACTOR IS ENERGISED BUT NOT LATCHED, AND THE SPEED REFERENCE IS PROVIDED BY THE JOG SPEED PRESET

MAIN SPEED

JOG

C2 IS A 2 POLE 2 WAY CHANGEOVER RELAY

1) JOG SPEED SUMMED WITH MAIN REFERENCE

2) JOG SPEED SELECTED BY SWITCH

3) JOGGING ON MAIN CONTACTOR WITH MAIN REFERENCE

4) JOGGING ON MAIN CONTACTOR WITH JOG SPEED REFERENCE



SPRINT ELECTRIC LTD. DOES NOT ACCEPT ANY LIABILITY WHATSOEVER FOR THE INSTALLATION, FITNESS FOR PURPOSE OR APPLICATION OF ITS PRODUCTS. IT IS THE USER'S RESPONSIBILITY TO ENSURE THE HEALTH AND SAFETY AT WORK. ELECTRICAL DEVICES CONSTITUTE A SAFETY HAZARD. IT IS THE RESPONSIBILITY OF THE USER TO ENSURE COMPLIANCE WITH ANY ACTS OR BY-LAWS IN FORCE. ONLY SKILLED PERSONS SHOULD INSTALL THIS EQUIPMENT.



The field bridge can be configured to suit various output voltages. It may be supplied separately or from the auxiliary supply fuses. Fuse rating see page 29. The field output current rating is 2.5A DC maximum.

FIELD

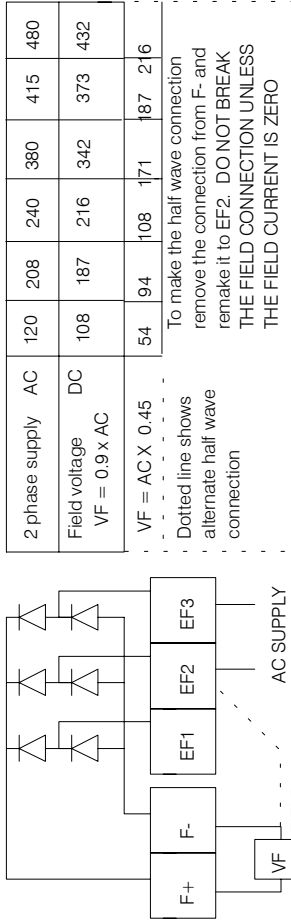

2 phase supply	AC	120	208	240	380	415	480
Field voltage	DC	108	187	216	342	373	432
	VF = 0.9 x AC						
	VF = AC X 0.45	54	94	108	171	187	216

To make the half wave connection remove the connection from F- and remake it to EF2. **DO NOT BREAK THE FIELD CONNECTION UNLESS THE FIELD CURRENT IS ZERO**

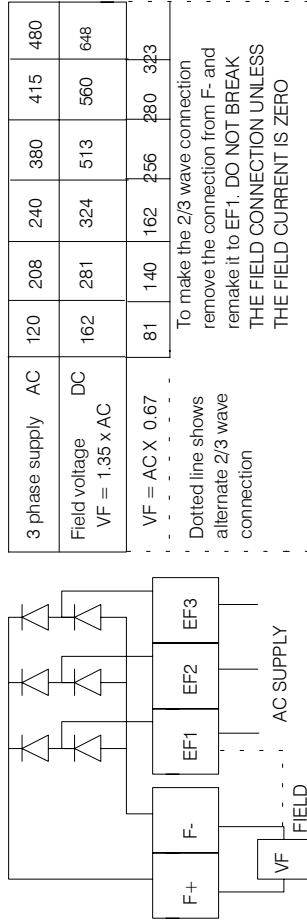

3 phase supply	AC	120	208	240	380	415	480
Field voltage	DC	162	281	324	513	560	648
	VF = 1.35 x AC						
	VF = AC X 0.67	81	140	162	256	280	343

To make the 2/3 wave connection remove the connection from F- and remake it to EF1. **DO NOT BREAK THE FIELD CONNECTION UNLESS THE FIELD CURRENT IS ZERO**

3) FIELD ENERGISED BY MAIN CONTACTOR

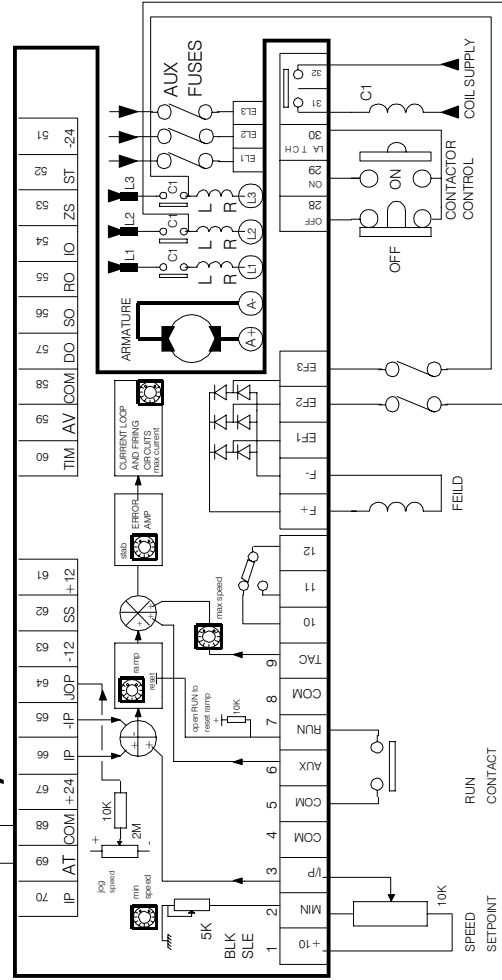

HEALTH AND SAFETY AT WORK ELECTRICAL DEVICES CONSTITUTE A SAFETY HAZARD. IT IS THE RESPONSIBILITY OF THE USER TO ENSURE COMPLIANCE WITH ANY ACTS OR BYLAWS IN FORCE. ONLY SKILLED PERSONS SHOULD BE PERMITTED TO WORK ON THESE DEVICES.

1) 3 PHASE HALF WAVE FIELD SUPPLY, ENERGISED BY MAIN CONTACTOR
2 PHASE HALF WAVE WHEN MAIN CONTACTOR DE-ENERGISED. (ECONOMY)

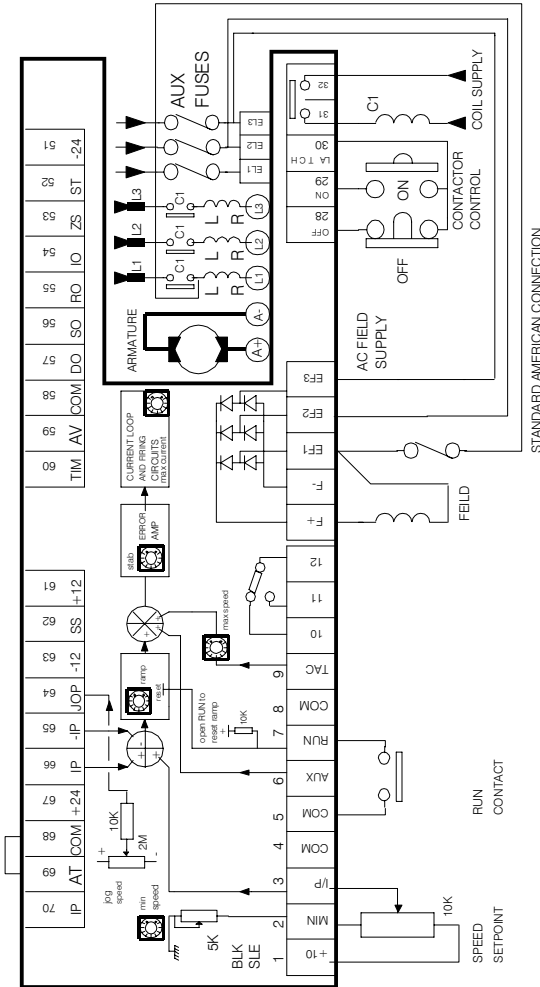

2) 2 PHASE FIELD SUPPLY USING DELAYED TURN OFF RELAY

SYSTEMS THE FIELD MUST REMAIN ENERGISED UNTIL THE MOTOR STOPS. MAKE C2 A DELAYED OFF TYPE CONTACTOR.

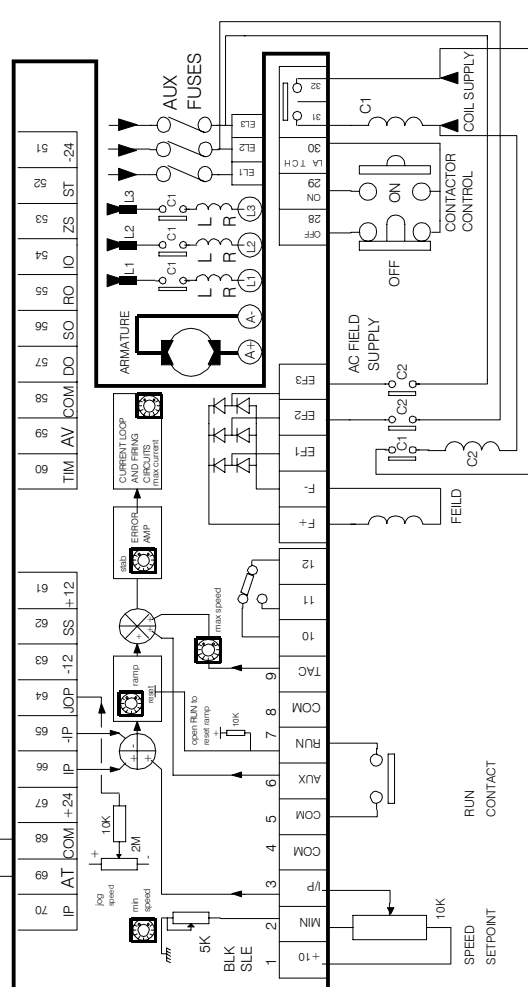

MODEL SLE 1) 3 PHASE HALF WAVE FIELD AND ECONOMY MODE
2) 2 PHASE FIELD SUPPLY WITH DELAYED TURN OFF
3) FIELD ENERGISED BY MAIN CONTACTOR

MODEL SLE SIGNAL PADS

Provision has been made on the MICRO ANALOG PROCESSOR to enable monitoring of some useful signals.

A layout of the MICRO ANALOG PROCESSOR is shown below. (Located on the left hand side of the unit).

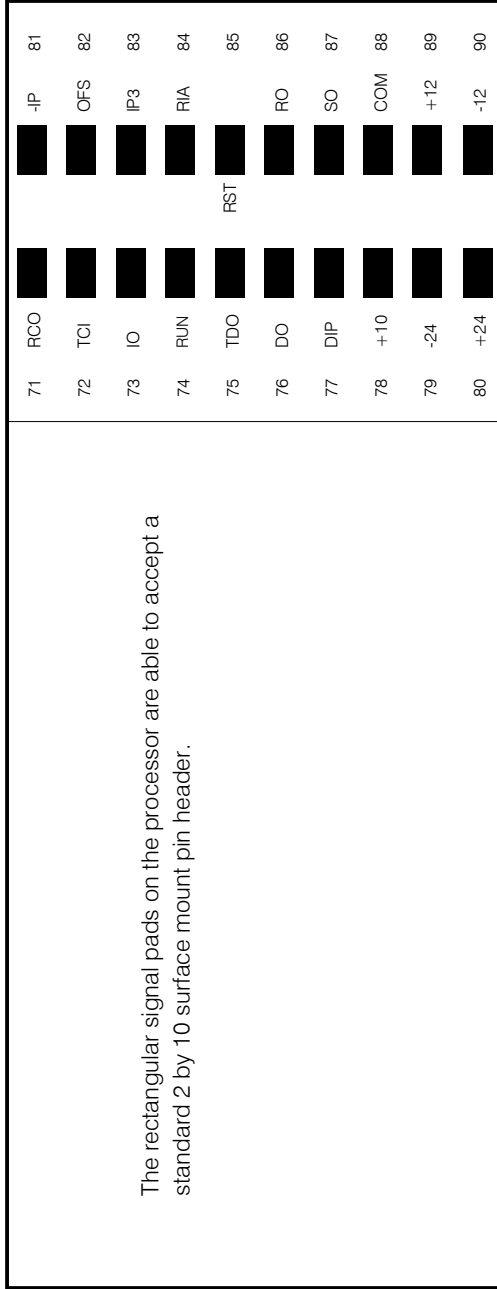

- Ramp Control Output.** This signal indicates the setpoint ramp status and is -11V when ramping up and 0V when the ramp has finished
- Torque Command Input.** This signal pad is connected to terminal 6 and shows the level of the auxiliary reference 0 to +/-10V
- Current Output.** This signal is connected to terminal 54 and shows the magnitude of the armature current. 0 to +5V for 0-100% current.
- Run.** Shows the status of the RUN signal within the drive. 0 to +11.5V when the RUN terminal 7 is open or main contactor disabled, 0V to run
- Torque Demand Output.** 0 to +7.5V represents 0 to 150% torque demand (armature current). +5V represents 100%.
- Demand Output.** 0 to -10V represents 0 to +100% speed demand. This signal is also on terminal 57.
- Direct speed Input.** This signal is also on terminal 70, and terminal 6 if the drive is in speed mode. 0 to +10V represents 0 to 100% speed.
- +10V.** ultra stable speed reference voltage. Also on terminal 1. Absolute value 10V +/-5%. Output capability 10mA maximum.
- 24V.** Unregulated -24V power supply. May vary between -18V and -32V depending on unit supply voltage and loading. 25mA max, T51
- +24V.** Unregulated +24V power supply. May vary between +18V and +32V depending on unit supply voltage and loading. 25mA max, T67
- Inverting ramped speed input.** Also on terminal 65. 0 to -10V represents 0 to +100% ramped speed demand. True bi-polar arithmetic summing.
- Offset speed input.** 0 to +10V represents 0 to -25% speed demand. This input is used for the 4-20mA signal loop offset function.
- Input terminal 3.** This signal is the main speed demand signal normally input via terminal 3. 0 to +10V for 0 to +100% speed demand.
- Ramp input Auxiliary.** Non-inverting speed input also on terminal 66. 0 to +10V for 0 to +100% speed demand. True bi-polar arithmetic summing.
- Ramp sum total.** This signal is the summation of all the speed ramp inputs. 0 to +5V represents 0 to +100% speed demand prior to ramping.
- Ramp Output.** This signal is the ramped version of the signal on 85. 0 to +10V represents 0 to 100% speed demand. It is also on terminal 55.
- Speed output.** This signal represents the scaled speed feedback signal, either tacho or armature volts. Full scale output is proportional to MAX SPEED preset rotation (4V ACW-9V CW). Also on terminal 56. Common. Electronic 0V
- +12V regulated rail.** 10mA maximum available. Tolerance 5%.
- +12V regulated rail.** 10mA maximum available. Tolerance 5%.

DRG No HF101748 ISS 8

TOL X +0.4 X.X +0.2 X.XX +0.1 HOLES < 7DIA +0.02 +0.07 ALL DIMENSIONS IN MM UNLESS OTHERWISE STATED.

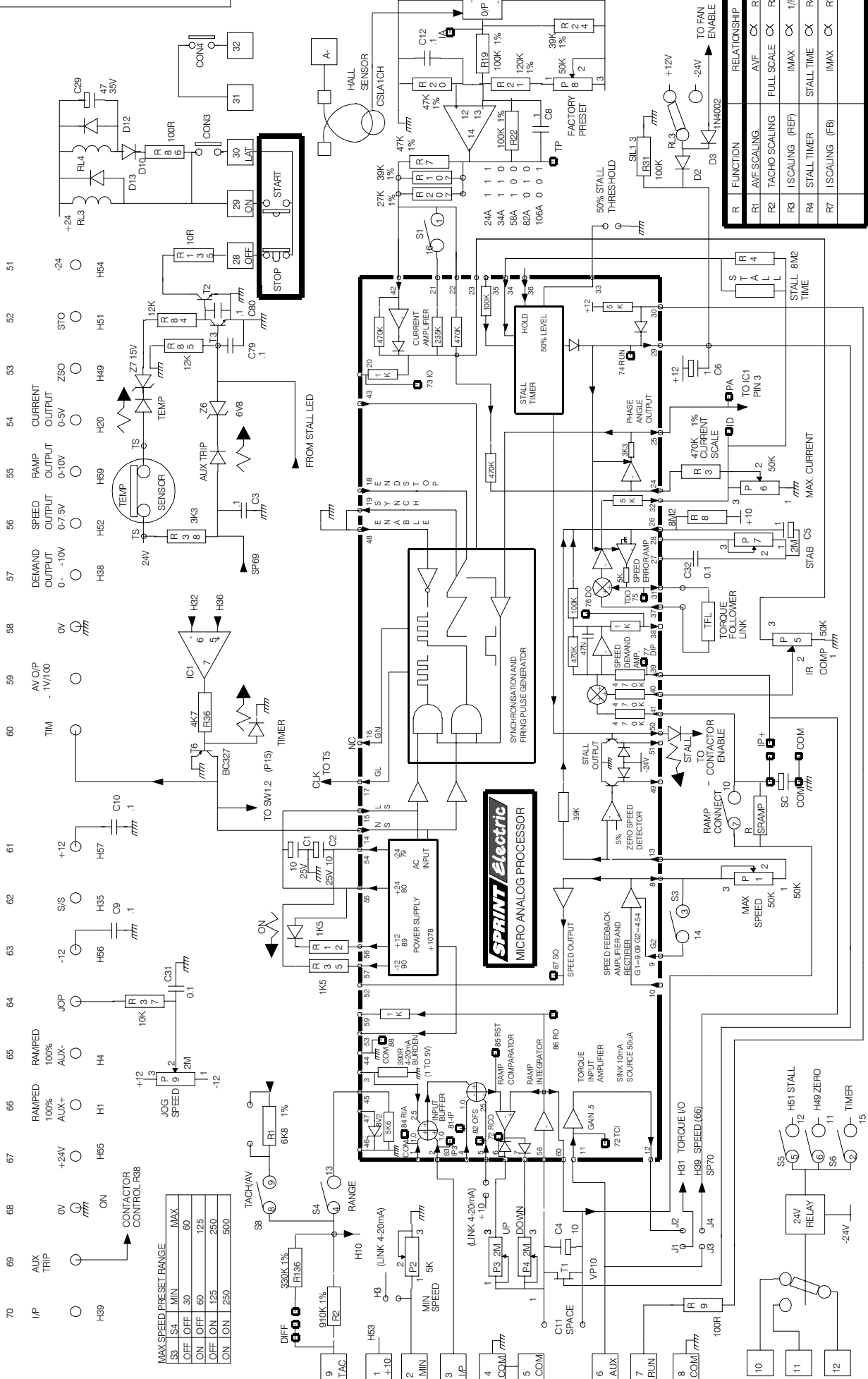

R	FUNCTION	RELATIONSHIP
R1	AVF SCALING	AVF CX R1
R2	TACHO SCALING	FULL SCALE CX R2
R3	I SCALING (REF)	IMAX CX 1/R3
R4	STALL TIMER	STALL TIME CX R4
R7	I SCALING (FB)	IMAX CX R7

- 51 STOP
- 52 STO
- 53 ZSO
- 54 H51
- 55 H54
- 56 H52
- 57 H59
- 58 H88
- 59 H82
- 60 H36
- 61 H57
- 62 H85
- 63 H56
- 64 H31
- 65 H4
- 66 H1
- 67 H5
- 68 H89
- 69 H89
- 70 H89
- 71 H89
- 72 H89
- 73 H89
- 74 H89
- 75 H89
- 76 H89
- 77 H89
- 78 H89
- 79 H89
- 80 H89
- 81 H89
- 82 H89
- 83 H89
- 84 H89
- 85 H89
- 86 H89
- 87 H89
- 88 H89
- 89 H89
- 90 H89
- 91 H89
- 92 H89
- 93 H89
- 94 H89
- 95 H89
- 96 H89
- 97 H89
- 98 H89
- 99 H89
- 100 H89

MAX SPEED PRESET RANGE	MIN	MAX
S3	30	60
OFF	60	125
ON	125	250
OFF	250	500
ON	250	500

ISS	DESCRIPTION	APPD	DATE	TITLE	CHECKED	APPROVED	DATE
R 39	C32	P 9	D 25	T 6	EJP	EJP	3/94
SPRINT ELECTRIC LTD RUDFORD IND EST FORD, ARUNDEL WEST SUSSEX BN18 0BE TEL (01903) 730000 FAX (01903) 730893							
SLE CONTROL CCT. DIA (POWER HF101747)							
DRAWN EJP							
DATE 3/94							
DRG No HF101748 cct. dia file ug101822 manual file							
ISS 9							



UNLESS SHOWN OTHERWISE ALL RESISTORS 1% 4W
ELECTROLYTICS MIN 50V CAPS NOTATED IN U/P

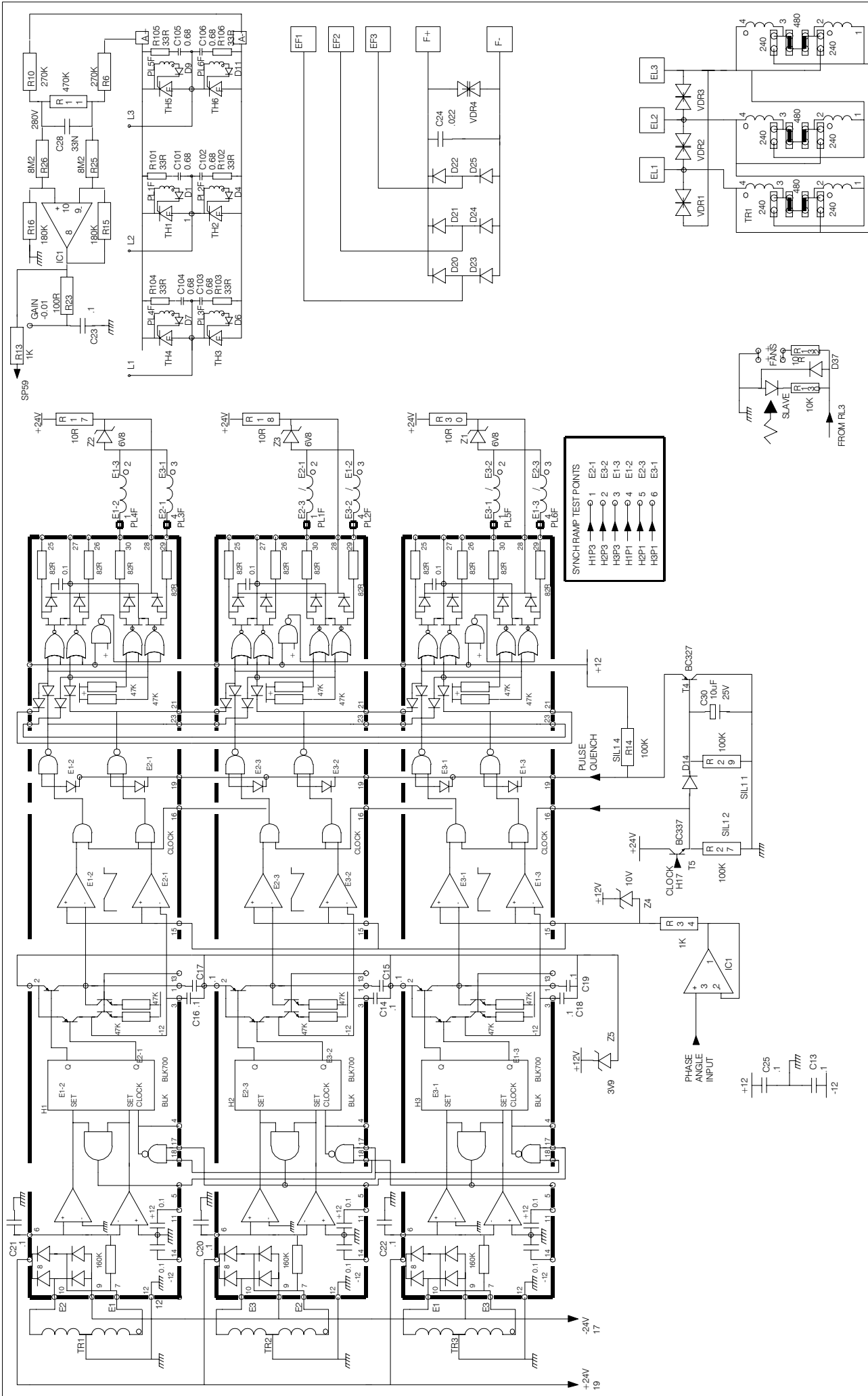

ISS	DESCRIPTION	APPD	DATE	TITLE	HIGH POWER	DATE	
SHT. 2 OF 2	CCT DIA.	EJP		3 PHASE POWER CCT.	SLE	3/94	
				(CONTROL HF101748)			
				SPRINT Electric 1994			
				DRG No	HF-101747 cct dia file.	ISS 8	
				CHECKED	EJP	APPROVED	A
				DRAWN	EJP		

CIRCUIT BOARD COMPONENT LAYOUT

LAYER 16 SILK SCREEN ISS 2
AD 101749

198.39 mm

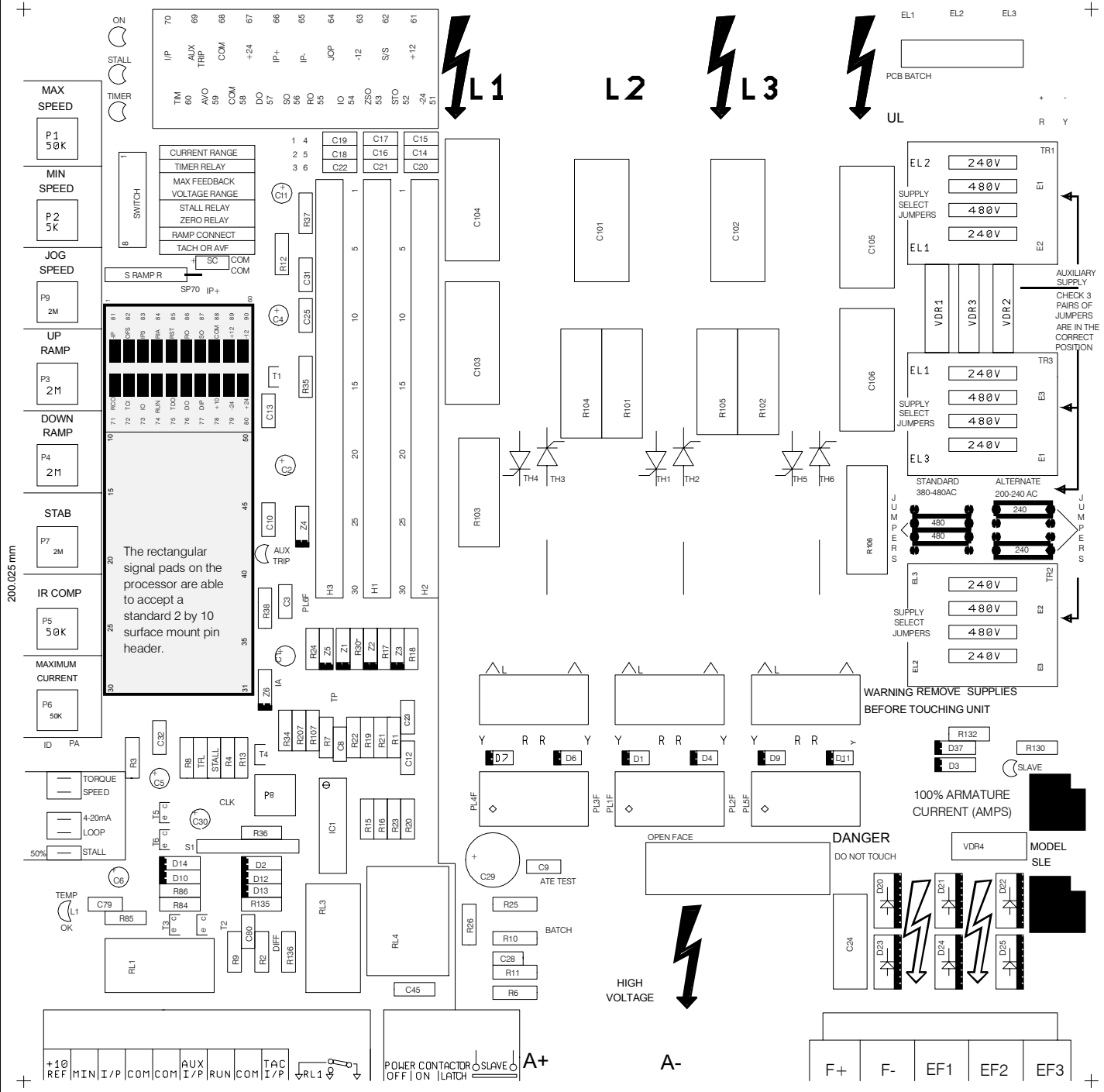

SPRINT ELECTRIC LTD. DOES NOT ACCEPT ANY LIABILITY WHATSOEVER FOR THE INSTALLATION, FITNESS FOR PURPOSE OR APPLICATION OF ITS PRODUCTS. IT IS THE USERS RESPONSIBILITY TO ENSURE THE UNIT IS CORRECTLY USED AND INSTALLED.

HEALTH AND SAFETY AT WORK. ELECTRICAL DEVICES CONSTITUTE A SAFETY HAZARD. IT IS THE RESPONSIBILITY OF THE USER TO ENSURE COMPLIANCE WITH ANY ACTS OR BYLAWS IN FORCE. ONLY SKILLED PERSONS SHOULD INSTALL THIS EQUIPMENT.

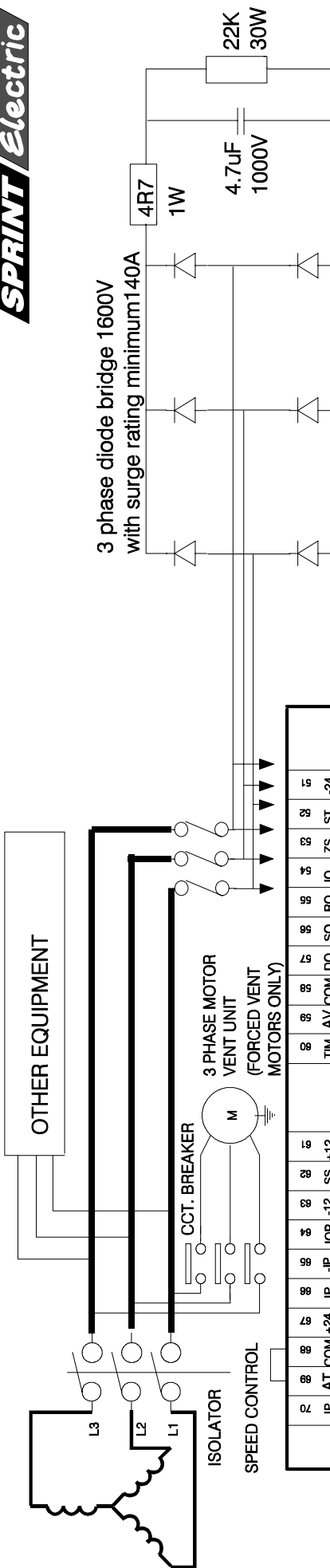

When the drive is being supplied from a local transformer, the commutation process in the thyristor bridge will cause high voltage overshoots to occur on the incoming supply. This is due to the inductance of the transformer and the lack of any other substantial load to absorb the high energy spikes.

The high energy spikes may cause damage to other equipment, the drive auxiliary inputs, the blower motor or unwanted thyristor triggering. To prevent this it is necessary to fit a supply conditioning BUCKET circuit to the drive supply.

The BUCKET circuit will soak up the spikes and prevent damage.

As a general rule a BUCKET circuit will be required with local transformer supplies unless the consumption of current by other non-inductive loads connected to the same transformer exceeds the drive current at any time.

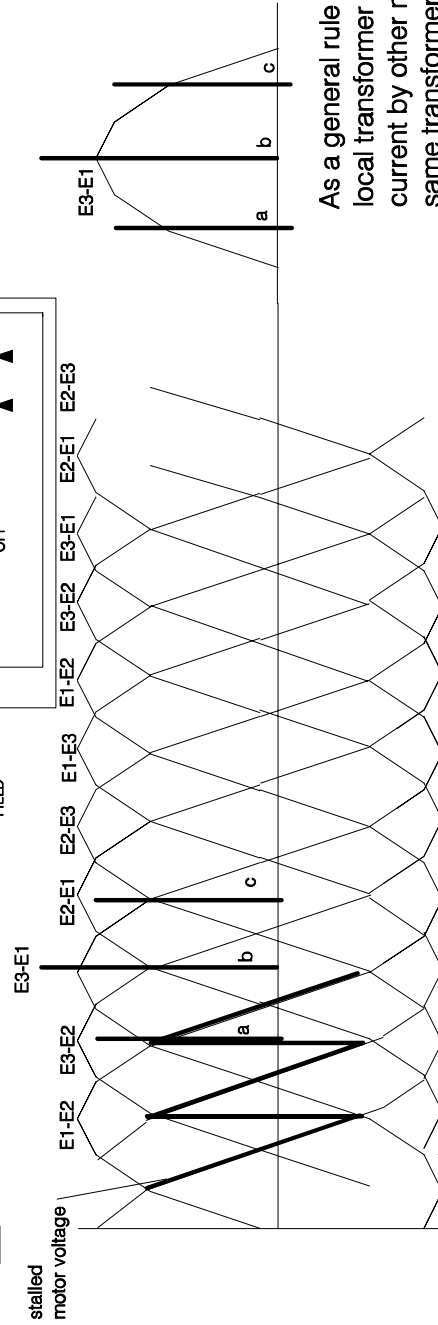

load voltage is zero for duration of commutation because E1-E3 are at zero

commutating from E1-E2 to E3-E2, E3-E1 are shorted due to notch (a) in E3-E1 is caused by E3 being shorted to E2 notch (b) in E3-E1 is caused by E3 being shorted to E1 notch (c) in E3-E1 is caused by E1 being shorted to E2

SPRINT ELECTRIC LTD. DOES NOT ACCEPT ANY LIABILITY WHATSOEVER FOR THE APPLICATION OF ITS PRODUCTS. IT IS THE USER'S RESPONSIBILITY TO ENSURE THE UNIT IS CORRECTLY USED AND INSTALLED.

HEALTH AND SAFETY AT WORK. ELECTRICAL DEVICES CONSTITUTE A SAFETY HAZARD. IT IS THE RESPONSIBILITY OF THE USER TO ENSURE COMPLIANCE WITH ANY ACTS OR BYLAWS IN FORCE. ONLY SKILLED PERSONS SHOULD INSTALL THIS EQUIPMENT.

Special consideration must be given to installations in member states of the European Union regarding noise suppression and immunity. According to IEC 1800-3 (EN6800-3) the drive units are classified as complex components only for professional assemblers, with no CE marking for EMC. The drive manufacturer is responsible for the provision of installation guidelines. The resulting EMC behaviour is the responsibility of the manufacturer of the system or installation. The units are subject to the LOW VOLTAGE DIRECTIVE 73/23/EEC and are CE marked accordingly. CE

Following the procedures outlined below will normally be required for the drive system to comply with the European regulations, some systems may require different measures. Installers must have a level of technical competence to correctly install. Although the drive unit itself is not subject to the EMC directive, considerable development work has been undertaken to ensure that the noise emissions and immunity are optimised.

★ EN6800-3 specifies 2 alternative operating environments. These are the domestic (1st environment) and industrial (2nd environment). There are no limits specified for conducted or radiated emissions in the industrial environment, hence it is usual for the filter to be omitted in industrial systems.

Definition of an industrial environment. All establishments other than those directly connected to a low-voltage power supply network which supplies buildings used for domestic purposes.

DRIVE INSTALLATION REQUIREMENTS FOR EMC COMPLIANCE

Keep parallel runs of power and control cables at least 0.3m apart. Crossovers must be at right angles

The AC supply filter must have a good earth connection to the enclosure back plane. Take care with painted metal to ensure good conductivity.

The metal enclosure will be the RF ground. The AC filter, drive earth and motor cable screen should connect directly to the metal of the cabinet for best performance

Linear control signal cables must be screened with the screen earthed at the drive end only. Minimise the length of screen stripped back and connect it to an analogue earth point

Keep sensitive components at least 0.3m from the drive and power supply cables

The AC input filter has earth leakage currents. Earth RCD devices may need to be set at 5% of rated current

The motor cable must be screened or armoured with 360 degree screen terminations to earth at each end. The cable must have an internal earth cable and the screen must extend into the enclosure and motor terminal box to form a Faraday cage without gaps

The AC connections from the filter to the drive must be less than 0.3m or if longer correctly screened

Do not run filtered and unfiltered AC supply cables together

Control signals must be filtered or suppressed eg control relay coils and current carrying contacts. The drive module has built in filters on signal outputs

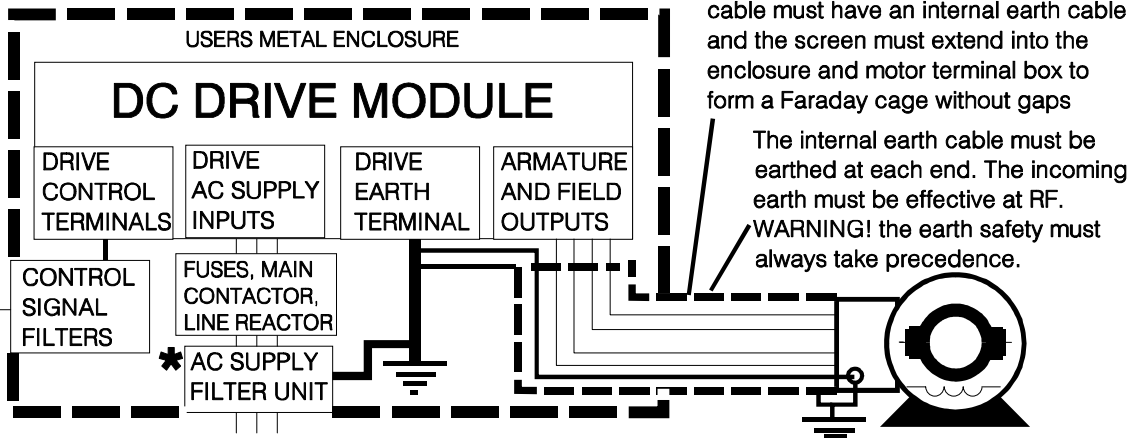

IMPORTANT SAFETY WARNINGS



The AC supply filters must not be used on supplies that are un-balanced or float with respect to earth

The drive and AC filter must only be used with a permanent earth connection. No plugs/sockets are allowed in the AC supply

The AC supply filter contains high voltage capacitors and should not be touched for a period of 20 seconds after the removal of the AC supply

MULTIPLE DRIVES WITH ONE FILTER AND EARTHING METHODS

The drive units are designed to function normally on unfiltered AC supplies shared with other thyristor DC drives. (not AC drives). The filter is rated for total load.

3 PHASE AC FROM MAIN FILTER UNIT

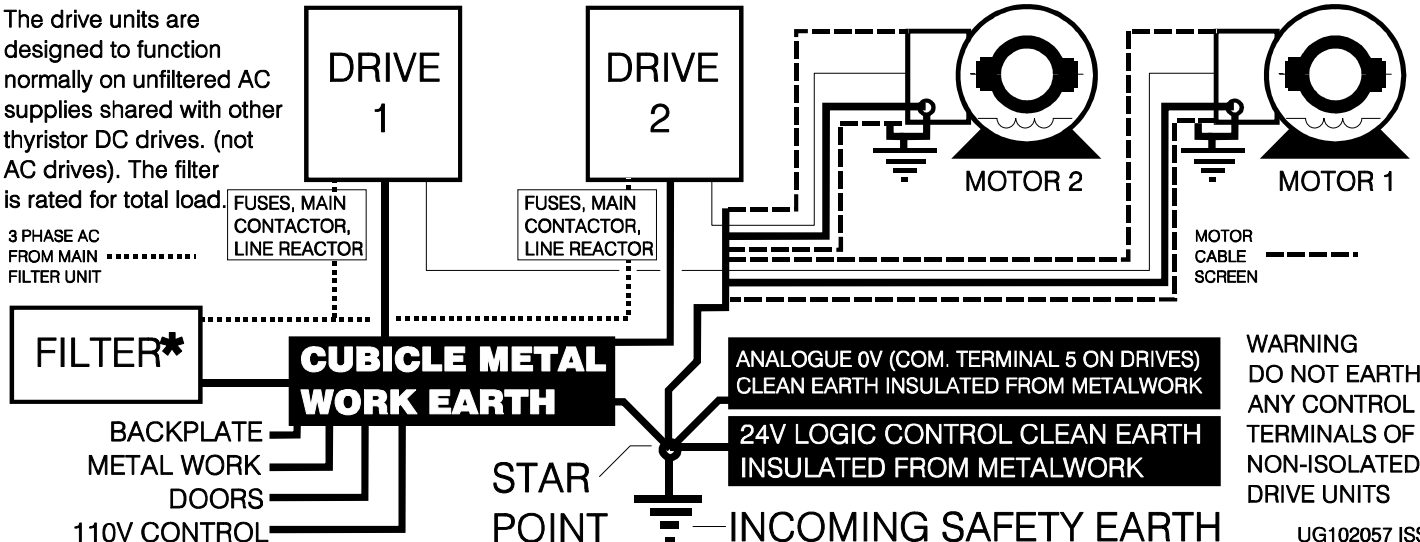

WARNING DO NOT EARTH ANY CONTROL TERMINALS OF NON-ISOLATED DRIVE UNITS

General 3 phase D.C. Drives Applications.

Larger DC motors normally 11KW and above require the use of 3 phase DC converters. Whilst there are many control comparisons with the 1 phase drives, the 3 phase converter has additional features which are useable in more sophisticated drive applications.

1. Field Weakening. (this function is not available on the SLE model)

An additional feature on the Sprint SL/SLX range of drives is auto field weakening. This built in device proportionately reduces the field flux, whilst maintaining the armature flux constant to give an increased speed output. Most DC motors have some inherent field weakening range which can be used to good effect on certain applications, as shown later. The output characteristic of the drive/ motor combination is as shown, and gives a flat top constant KW characteristic to the motor. Field ranges in excess of 3:1 can be achieved at the smaller KW sizes (say up to 30KW) but reduces as the DC motor gets larger.

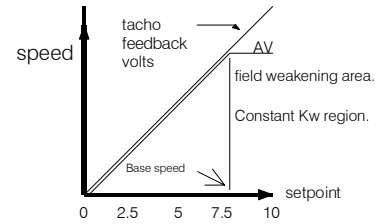

2. Load Sharing

Where an application demands close control between a number of drives, but any one drive must not be allowed to overhaul the rest, Sprint drives are configurable for load sharing. Each drive is given an equal torque demand, so any change in load demand is shared equally between drives. The simplest form of this is a nip, containing product, where each roll is driven. If both drives were independent, it is likely one of the drives would start to drive the other, to a point where one drive was idling and the other was taking twice the load. There can be several configurations of mechanical systems that involve load sharing, but they invariably have a product web of some type (metal, paper, textile) joining them together in the process line. The drive configuration is described in the Sprint application manual.

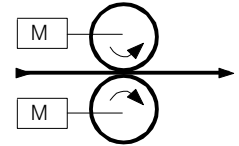

3. Master/Slave Applications.

Where a process involves multiple drive sections that require speed following, all Sprint 3 phase drives are configurable for master/slave operation. A number of follower drives can be controlled from single master drive so that an increase or decrease in the master speed produces a proportionate increase or decrease in the speeds of the following drives. Most multi drive process lines have some form of master/slave operation to allow the operator a single pot control for the machine (see Figure 3)

Caution!

If the process line has follower drives that require increases in speed relative to the master, say metal forming or wire drawing, the relative increase must be accounted for in the mechanical system, as the master drive will only give out a maximum speed signal to the followers i.e. if the last drive on the system is 20% faster than the master, an increased output speed on the motor must be selected to accommodate this. The drive configuration is described in the Sprint application manual.

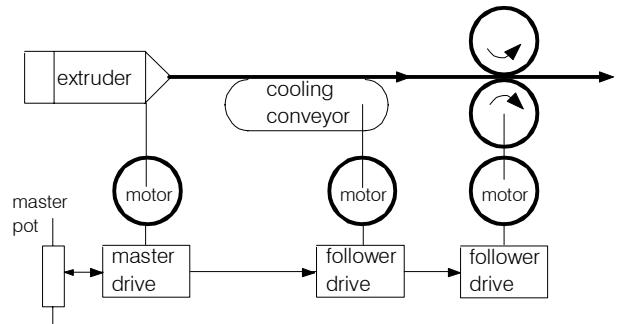

4. Winder Applications.

For coiling applications using any materials, there are a number of fundamental principles which apply.

- a) The power (KW) requirement is the same at any diameter to maintain a constant tension in the product.
 - b) When selecting a suitable motor for winding applications, the maximum torque output is at maximum reel diameter, the maximum speed is at minimum diameter.
 - c) The operating speed range of the drive motor combination is not just the reel build up, but is additional to the line speed.
- Constant tension in the reel is normally desired to prevent the core from overtightening and/or crushing.

To determine the motor power, we need the maximum torque applied, and the maximum speed of the motor shaft.

The maximum torque is at the O/D of the reel., ie:

$$\begin{aligned} \text{Torque} &= \text{Tension (n)} \times \text{Radius (m)} \\ &= 200n \times 0.32\text{m} &= 64nm. \end{aligned}$$

The maximum speed is at the I/D of the reel.

$$\begin{aligned} \text{And } N_{\text{max}} &= \frac{\text{Max line speed (m/min)}}{\text{Core circumference (m)}} \\ &= \frac{100\text{M/min}}{2 \times \pi \times 0.32} &= 500\text{RPM} \end{aligned}$$

$$\begin{aligned} \text{Required motor KW} &= \frac{T(\text{nm}) \times n (\text{rpm})}{9549} \\ &= \frac{64nm \times 500\text{RPM}}{9549} &= 3.35\text{KW}. \end{aligned}$$

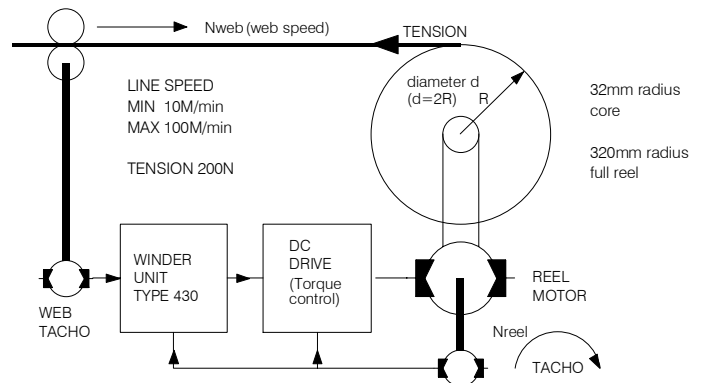

This would be the selected motor KW to give max torque and maximum speed for the conditions above. Acceleration torque must be added to the above to provide a complete picture. With the reel at maximum diameter, additional motor power is required to accelerate the reel and maintain tension during acceleration.

It should also be noted that if the line was running at minimum speed, and the reel was near maximum, the actual motor shaft speed would be:

$$N \text{ RPM} = \frac{10\text{m/min}}{2 \times \pi \times 0.32} = 5 \text{ RPM (at maximum torque)}$$

The motor/drive combination should therefore be capable of a speed range of 5-500RPM i.e. 100:1, and for this reason most coilers require a very wide speed range. This speed range (100:1) is normal with Sprint 3 phase drive and motors fitted with tachogenerators, but please check the motor is capable of the speed range. Sprint have available a winder card which takes a line speed ref and compares it with the drive motor speed to give automatic control of motor torque (and thus of tension) as the reel builds up. Other features available on the winder card are:

Inertia Compensation A large heavy reel may require additional torque during acceleration to prevent the reel "lagging" behind the line - a pre-settable compensation function is provided to help prevent this.

Static Compensation: Frictional losses in the mechanical system will subtract from the torque applied by the motor. An offset is provided for this.

Dynamic Compensation: Other effects such as "windage" i.e. rotating losses can be compensated for.

Taper Current Control: Certain applications require the tension to be "backed off" as the reel diameter increases, useful when winding say paper onto soft cardboard cores to prevent core crushing. The taper setting is variable and set as required. See the Sprint winder card manual.

5. Regenerative Drives. (This function is not available on the SLE model)

The Sprint SLX range of drives offer a fully regenerative package suitable for controlled electronic braking and reversing. Whilst much is often made about AC drives and energy saving, the 4 quadrant DC drive is the most energy efficient drive. AC inverters usually have some form of braking resistor, effectively burning away the energy on the stopping cycle. Regenerative DC drives return their braking energy to the mains supply, where it can be drawn on by connected plant. As the conversion efficiency of the drive is approximately 99%, very little is wasted. This feature can be used to positive effect for haulage type systems, and can be a major selling feature. The regenerative DC drive is a highly flexible drive that can be applied to even the most arduous applications. High speed braking and reversing make it suitable for machine tool spindle drives, test rigs of all descriptions, winding applications where the reel is likely to be overhauled, out of balance loads, high speed textile machinery. It is also the case that where normal braking and some reverse facility is required, the installed cost of a 4 quadrant drive is likely to be less than fitting dynamic brake and reversing contactors, with single ended drives.

6. Standard And Non Standard Voltages.

All Sprint 3 phase drives are designed to operate with supply voltages of 190-250V or 380-500V, depending on the positions of the on-board supply voltage jumper links. The maximum output voltages from the drive will then be 1.1 x supply voltage for the armature and 0.9 x supply voltage for the field.

Occasionally motor voltages occur at values much lower than the available supply voltage. Although the average drive output can be limited to lower voltages by the on board presets, it is not recommended that this be done. For example, with a 415V supply the output may still contain 600V peaks, which when presented to a 110V DC motor, say, could break down the motor insulation. It is better to provide a low voltage AC supply to match the motor rating.

This can be done by feeding the main supply terminals at low voltage (e.g. 100V) from a suitable transformer, while still feeding the auxilliary supply direct from the mains (e.g. 415V). Circuits describing this are shown in the applications manual. The cost of the transformer is offset by the fact that no line reactor is required in this configuration.

7. Industry Applications For 3 Phase Drives.Plastics.

Extruders Usually non regenerative, simple drives. Almost all request a zero reference interlock, which is a link to the zero speed relay to prevent re-starting at speed after a stop condition.

Blown Film Extrusion head as above.

Rubber Extruders - As plastic extruders.

Mixers - Non regenerative, simple drives, but with an exception. Most mixers operate under a duty cycle, say as follows:
Cycle 1 - 200% full load torque - 15 secs, Cycle 2 - 90% full load torque - 30 secs. Cycle 3 - 40% full load torque - 45 secs. If we were to size the drive/motor for 100% torque it would trip on the first cycle. The RMS value of the duty must be considered.

Machine Tools

Spindle Drives. Mainly regenerative, usually controlled through a CNC system. Motors must be well protected against coolant and dirt. Most use field weakening for constant KW.

Feed drives Mainly regenerative, mostly in the single phase range.

Metals.

Rolling Mill Mainly regenerative due to reversing duty. Usually large KW arduous duty.

Slitting and Coil Winding Machines mainly regenerative, both slitters and coil winders. Slitting systems usually simple drives, coil winders can be complex.

Metal Forming M/c Mainly non regenerative, one converter driving the whole machine

Wire Drawing Usually multi drive systems, each section increasing in speed. Mainly regenerative, with increase motor speed controlled by field controller. Rewind is usually a bobbin, not DC controlled.

Cable production Combination of extruder and cable handling. Haul off is regenerative, along with rewind stands.

Bunchers and Strandors Generally regenerative in medium systems along with take up stand.

Paper and Board

Paper Production Usually large high cost control systems for complete paper machines. Mix of drives from large - small KW.

Board Production Mix of regenerative and non regenerative drives. Cutters usually regenerative medium sized systems.

Printing Presses. Almost invariably regenerative, and may require digital locking for print control, can be complex systems.

ReReelers and Slitters. Regenerative drives requiring accurate control of motor torque.

Test Rigs. Usually high response complex systems requiring fully regenerative drives, and utilising many of the drives control functions, torque, speed outputs etc.

Textiles.

Spinning Frames Usually regenerative drives for braking control. Drives systems fairly simple but modern computer control making the interface more complex. Non reversing.

Carding Machines. Can be non regenerative on simple card applications. Non reversing.

Sprint Electric Limited
Arundel, UK

Tel. + 44 (0)1903 730000
Fax. + 44 (0)1903 730893
Email. info@sprint-electric.com

www.sprint-electric.com