



SL Series

THREE PHASE

DC MOTOR CONTROLLER

2Q

WORLD CLASS IN DESIGN · WORLD BEATING IN FUNCTION

IMPORTANT SAFETY NOTES

READ AND UNDERSTAND THIS MANUAL BEFORE
APPLYING POWER TO THE SL MOTOR DRIVE UNIT

The SL motor drive controller is an open chassis component for use in a suitable enclosure

Drives and process control systems are a very important part of creating better quality and value in the goods for our society, but they must be designed, installed and used with great care to ensure everyone's SAFETY.

Remember that the equipment you will be using incorporates...

High voltage electrical equipment

Powerful rotating machinery with large stored energy

Heavy components

... and your process may involve ...

Hazardous materials

Expensive equipment and facilities

Interactive components

Always use qualified personnel to design, construct and operate your systems and keep SAFETY as your primary concern.

Thorough personnel training is an important aid to SAFETY and productivity.

SAFETY awareness not only reduces the risk of accidents and injuries in your plant, but has a direct impact on improving product quality and costs.

If you have any doubts about the SAFETY of your system or process, consult an expert immediately. Do not proceed without doing so.

HEALTH AND SAFETY AT WORK

Electrical devices can constitute a safety hazard. It is the responsibility of the user to ensure the compliance of the installation with any acts or bylaws in force. Only skilled personnel should install and maintain this equipment after reading and understanding this instruction manual. If in doubt refer to the supplier



Note. The contents of this manual are believed accurate at the time of printing. The manufacturers, however, reserve the right to change the content and product specification without notice. No liability is accepted for omissions or errors. No liability is accepted for the installation or fitness for purpose or application of the SL motor drive unit.

SECTION 1 BASIC INFORMATION

- 1.1 General description
- 1.2 Specification
- 1.3 Main terminal listing
- 1.4 Auxiliary terminal listing
- 1.5 Customer presets
- 1.6 Block diagram
- 1.7 Basic application
- 1.8 Important operating considerations

SECTION 2 SET UP PROCEDURE

- 2.1 Visual checklist
- 2.2 Function switches
- 2.3 Jumpers, links, S ramp
- 2.4 Initial power up
- 2.5 Stop start and demand
- 2.6 Powering motor
- 2.7 Running checks
- 2.8 Stability adjustment

SECTION 3 SUPPLEMENTARY DATA

- 3.1 Alarms
- 3.2 Field voltage display
- 3.3 Inhibit block diagram
- 3.4 Setpoint ramp graphs
- 3.5 Torque functions
- 3.6 Torque control
- 3.7 Stall timer
- 3.8 Field control
- 3.9 Field control and diagnostic
- 3.10 Fault finding chart
- 3.11 Fault finding
- 3.12 Speed scaling worked example
- 3.13 Rating table
- 3.14 Fuse table
- 3.15 Dimensions up to SL145 and venting
- 3.16 Dimensions SL185/225/265 and venting
- 3.17 Line Reactor dimensions
- 3.18 Maintenance
- 3.19 Applications notes
- 3.20 Applications notes

TYPICAL APPLICATIONS (wiring diagrams) section 5		10	Simple dancing arm
1	Basic connections	11	Jog applications
2	Basic connections	12	Jog and crawl applications
3	Basic connections	13	MICRO ANALOG PROCESSOR
4	Winder application	14	Stopping applications
5	Speed following. Load sharing	15	Stopping applications
6	Master setpoint multi drive	16	Low voltage applications
7	Main contactor applications	17	local transformer supplies
8	Zero reference interlock	18	EMC installation guidelines
9	Reversing		

Index

GENERAL DESCRIPTION

The units employ closed loop control of both armature current and feedback voltage to give precise control of the motor torque and speed.

The motor and drive are protected by a stall timer which automatically removes power after 30 seconds if the required speed cannot be achieved. The drives will provide up to 150% of the preset maximum current for up to 30 seconds allowing high short term torques during acceleration or other changes in load. Independent control of either the current or speed loops by external inputs allows torque or speed control applications with overspeed or overcurrent protection. The demand signal may be derived from a potentiometer, 0-10V signal or 4-20mA loop. The speed feedback signal may be selected to be the ARMATURE VOLTAGE or a shaft mounted TACHOMETER.

The drive consists of 2 high accuracy feedback control loops.

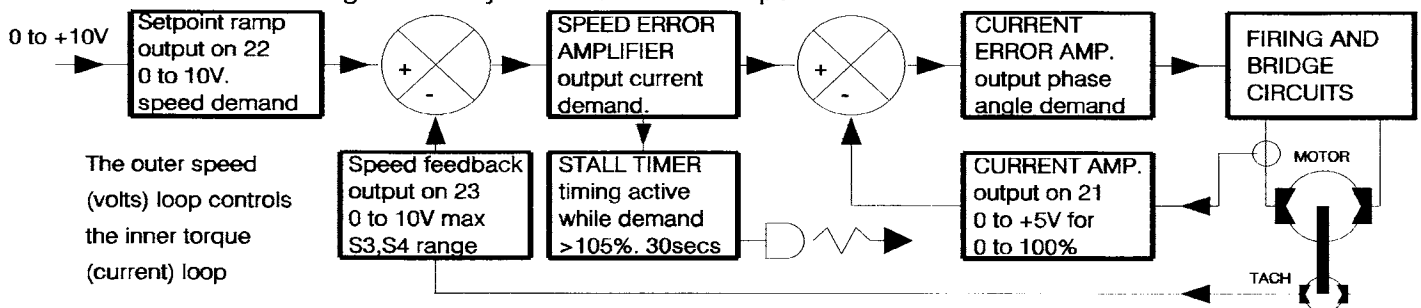

A fully regulated field bridge is provided. This may be switched to provide constant field current for accurate armature voltage feedback, or automatic field weakening for extended speed range.

There is also an extra cost option for increased output field current on all models.

ELECTRICAL SPECIFICATION

SUPPLY VOLTAGE low tap high tap
 3 phase 50/60Hz 200/240 380/480 +/- 5%
 separate in phase supply to stack
 SL185-265 need 50VA 110V 50/60Hz ac fan supply

ARMATURE VOLTS Max. 1.1 times AC supply
 AC supply 240 380 415 480
 AV DC max 265 420 460 530

FIELD Maximum output volts 0.9 times AC supply.
 Adjustable output voltage with trend display.
 Current regulation for high accuracy AVF speed control.
 Automatic weakening mode switch selectable.
 Delayed quench for emergency dynamic braking.
 Economy mode for motor climate control.
 Special option high current field on all models.

TEMPERATURE (class 3K3)
 0-50C ambient cubicle internal operating temp
 -25C to +55C storage (class 1K4)
 See sec 3.15 /16 for ventilation requirements
 UL rating is 40C maximum ambient

RELATIVE HUMIDITY (class 3K3)
 5 - 85% non-condensing

ALTITUDE (class 3K3)
 1000m (86Kpa - 106Kpa)

THYRISTOR BRIDGE 3 Phase fully controlled
ELECTRICAL ISOLATION

high voltage power circuits are isolated from
 control circuits (the COMMON terminal must be
 earthed for protective class 1 code compliance)

PUSHBUTTON INPUTS
 STOP JOG POWER ON
 START AUX. I/P POWER OFF

PRESET CONTROLS	LINK OPTIONS
MAX SPEED	50% Stall level
MIN SPEED	S shaped ramps
JOG SPEED	0/4 - 20mA loop
UP RAMP	speed mode
DOWN RAMP	torque mode
SPEED STABILITY	zero standstill
ZERO SPEED	zero ref. interlock
MAXIMUM CURRENT	
FIELD CURRENT	
AUTOMATIC FIELD WEAKENING	

JUMPER OPTIONS
 speed/torque

PRESET SWITCHES

1 field mode	5 relay 1 stall
2 relay 1 timer	6 relay 1 zero
3 speed scale	7 long ramp
4 speed scale	8 tac/av

CONTACT RATINGS
 1A AT 120V AC (see 1.3) main contactor slave

PERFORMANCE SPEC.

TYPE	KW at 460V AV	HP 500V AV	HP 500V AV	ARM amps	FIELD std	amps option
*SL5	5	6.6	7.5	12	2.5	7.5
*SL10	10	13.3	15	24	2.5	7.5
*SL15	15	20	20	36	2.5	7.5
*SL20	20	26.6	30	48	2.5	7.5
*SL30	30	40	40	72	5.0	10.0
*SL40	40	53.3	60	96	5.0	10.0
*SL50	50	66.6	75	120	5.0	10.0
SL65	65	90	100	155	10.0	15.0
SL85	85	115	125	205	10.0	15.0
SL115	115	155	160	270	10.0	15.0
*SL145	145	190	200	330	10.0	15.0
SL185	185	250	270	430	10.0	30.0
*SL225	225	300	330	530	10.0	30.0
SL265	265	350	400	630	10.0	30.0

*these models have a 3Q regenerative stopping facility

SPEED RANGE
 100:1 with DC tacho speed feedback
 20:1 with armature volts feedback

STEADY STATE ACCURACY
 0.1% with tacho feedback

OVERLOAD CAPACITY
 150% full load current for 30 secs.

SHORT CIRCUIT RATING (see fuse table sec. 3)
 Suitable for use on a circuit capable of delivering not
 more than 5,000A (SL5-30)/10,000A (SL40-145)/
 18,000A (SL185-265) RMS symmetrical amperes,
 480 Volts maximum. When protected by aR class fuses.

TORQUE LIMIT CONTROL
 0 to 100% of max current setting
 Link selectable overload timer detector level (to 50%)

DYNAMIC INDICATORS
 positive demand timer
 negative demand field voltage
 stall weakening threshold

LATCHED INDICATORS
 field loss peak current
 tacho loss aux input
 All latched with individual override and internal or
 external reset.

SIGNAL OUTPUTS
 linear isolated

**RAILS AND
 DRIVERS**

speed
 current
 setpoint ramp
 total setpoint
 field current
 rectified arm. volts
 rectified arm. amps
 current demand

+10 +12 +24
 -10 -12 -24
 1)stall 2)timer
 3)zero 4)reverse
 phase loss
 field loss
 tacho loss
 peak amps
 aux trip

POWER CARD

L1 line 1 MAIN INCOMING 3 PHASE SUPPLY
 L2 line 2 PHASE ROTATION NOT IMPORTANT
 L3 line 3
 A+ + DC output MOTOR ARMATURE CONNECTIONS
 A- - DC output

TERMINAL TORQUE

SL5-50 35 lb - in. or 3.9 N - m
 SL65-145 242 lb - in. or 27 N - m
 SL185-265 242 lb - in. or 27 N - m



INTERNATIONAL GROUND SYMBOL (BLACK ON GREEN BACKGROUND) IDENTIFIES MAIN EQUIPMENT GROUND CONNECTION ON UNIT HEATSINK

EL1
 EL2 AUXILIARY SUPPLY PHASING
 EL3 MUST EQUATE TO L1 L2 L3
 F+ + DC output MOTOR FIELD CONNECTIONS
 F- - DC output

SL5-50 9 lb - in. or 1.0 N - m
 SL65-145 9 lb - in. or 1.0 N - m
 SL185-265 35 lb - in. or 3.9N - m

110V AC SUPPLY
 Note. Models SL185/225/265 will need a 50VA 110V AC fused fan supply fed to the control terminals at the top left hand side of the unit. The drive unit automatically controls the fan.

UL Connection information. Copper conductors rated 60C only, or 75C for units rated over 100A.



(WARNING. RUN is an electronic inhibit function. The field remains energised, and all power terminals remain 'live'. RUN must not be relied upon during hazardous operations)

120V AC/ 24V DC 1A max contact rating

10	RATINGS ACCORDING TO CSA	
11	VOLTAGE RATING OF RELAY TERMINALS 10/11/12 MUST NOT EXCEED 30V AC OR 42.4V DC.	
12		

TERMINAL LISTING See 1.4 for top edge terminals.

- control terminal torque T1 - T32 7 lb - in. or 0.8 N - m
- +10 volts +/-5% output. 10mA. Precision low drift pot reference.
 - MIN INPUT. 5K preset to COM. Also accepts 4-20mA LOOP signals
 - Main SPEED INPUT. 0 to +10V. This input is ramped.
 - 10V volts output. 10mA.
 - COMMON. 0 volts (COMMON must be earthed for protective class 1)
 - AUX. INPUT 0 to +10V. Direct speed or torque according to jumper on control card. 2Q TORQUE/ SPEED
 - RUN. Drive is inhibited if T7 is open. Connect to 0V to run. Internal pull up to +12V via 4K7.
 - COMMON (0V). normally used as tacho common.
 - Negative TACHO feedback input. Full speed scaling by switches 3/4

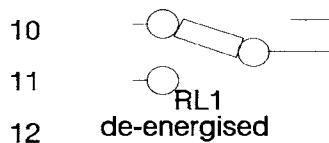

- S2 when ON, RL1 de-energises if current demand > 105%
- S5 when ON, RL1 de-energises if stall timer latches out.
- S6 when ON, RL1 de-energises if speed remains below 1%

If more than one switch is ON the functions are "ANDED"

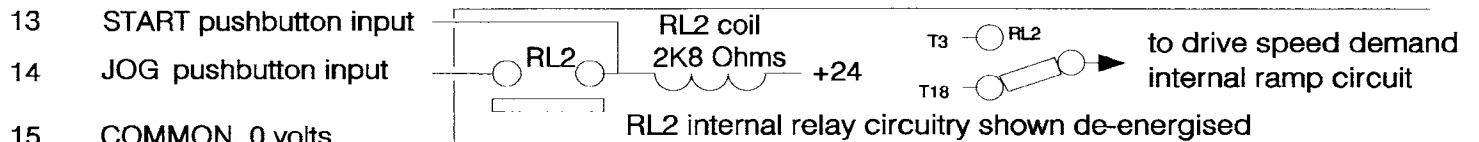

- START pushbutton input
- JOG pushbutton input
- COMMON. 0 volts
- BRAKE ENABLE. Connect to common to enable regenerative stopping mode. 100K pull up to +24V Note this function is not operative on models SL65/85/115/185/265.
- TOTAL SETPOINT OUTPUT (INVERTED) +/-10V. 1KOhm.
- XIP speed demand input. selected by RL2. see T13/14. Also JOG SPEED reference 0 to +1V 470K imp.
- AUXILIARY SPEED INPUT +/-10V FOR +/-100% SPEED
- AUXILIARY INVERTING SPEED INPUT +/-10V, +/-100%
- CURRENT OUTPUT. 0 to +/-5V for 0 to +/-100%. 10 Ohm.
- RAMPED SETPOINT OUTPUT 0 to +10V for 0 to 100%. 1k Ohm.
- SPEED OUTPUT. 0 to +/-10V full scale. 10 Ohm.
- FIELD CURRENT OUTPUT. 0 to 5V for 0 to 100% field current. 1K Ohm. See specification for model ratings.
- AUX. TRIP Trips drive if resistance to 0V > 2K
- RESET. All alarms except STALL when taken to 0V. 47K pull up to +24V.
- COMMON (0V).

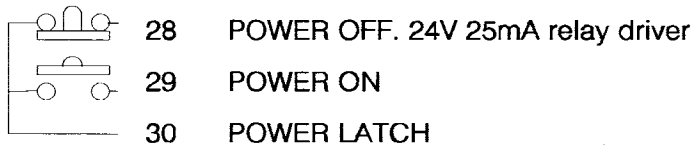

POWER ON/OFF this configuration causes contactor drop out if any alarm is triggered. 24V DC operating voltage on 28, 29, 30

See Typical Applications

- INTERNAL SLAVE RELAY to drive main supply
- contactor. 120V AC 1A max./ 24V DC 1A max. CSA rating. (Max switching voltage 250V AC at 1A) (Suppress the external contactor coil with an RC snubber (100R + 0.1uF))

All models have terminals on the top edge of the control card, marked 51 to 70. NOTE the terminal numbering system is common to the whole range. The prefix T refers to a terminal. There are 4 external relay driver outputs. ST, ZS, TIM are also available on the T10/11/12 relay

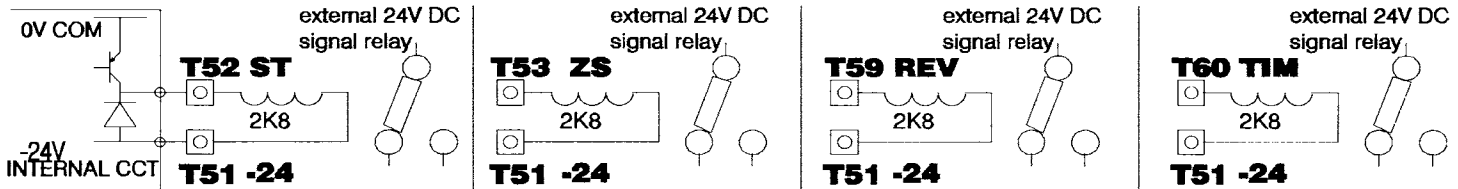

T51 -24 volt rail. unregulated, unprotected, may vary between -35V and -18V depending on loading and supply. This rail is primarily provided to supply external signal relays used in conjunction with T52, T53, T59, T60. Output capability 25mA. Do not overload or short. Note. If more than 1 relay is employed the minimum combined resistance is approximately 1K Ohm for simultaneously energised relays.

T52 ST Stall relay driver. PNP open collector output. -40V max voltage when off. 50mA max current when on. Note a flyback diode for the relay coil is included internally. The driver is de-energised during the STALL condition.

T53 ZS Zero speed relay driver. PNP open collector output. -40V max voltage when off, 50mA max current when on. Note a flyback diode for the relay coil is included internally. The driver is de-energised during the zero speed condition. (speed below 1%).

T54 IDO Rectified current demand output. 0 to -5V represents 0 to 100% current demand. 1K series buffer resistor. Maximum output -7.5V for 150% demand.

T55 RO Ramp output. 0 to +10V represents 0 to 100%. Setpoint ramp. 1K series buffer resistor. Short circuit protected. Also on T22.

T56 AV Armature voltage modulus output. 0 to +10V for 0 to +/-500V. 1K series buffer resistor

T57 DO Demand output. 0 to -10V represents 0 to +100% total speed demand. This is the final summation of all the speed demand inputs. 1K series buffer resistor. Also on T17.

T58 COM Common. 0V for drive electronics. Also on T5, T8, T15, T27 and T68. (one of these must be earthed for protective class 1)

T59 REV Reverse relay driver. PNP open collector output. -40V max. voltage when off, 50mA max. current when on. A flyback diode is included. This driver is de-energised for speeds below 5% OR reverse rotation.

T60 TIM TIMER relay driver. PNP open collector output. -40V max. voltage when off, 50mA max. current when on. A flyback diode is included internally. This driver is de-energised when the stall timer starts to integrate. (ie. if current demand exceeds 105% of preset level)

T61 +12 regulated rail. 10mA capability, short circuit protected. This rail provides power to the drive electronics, the drive will not function while this rail is shorted. If it is used for external circuitry please ensure that it is buffered from possible interference by inserting a series resistor as close as possible to T61. A value between 10 and 100 Ohms should be adequate.

T62 SS STOP/START this input can be used to latch or unlatch the stall circuit. It may be necessary to de-couple this with a 0.1uF capacitor to COM. To unlatch or reset the stall circuit, momentarily connect T62 to T61 (+12V). To latch the stall circuit, momentarily connect T62 to T63 (-12V).

T63 -12 regulated rail. 10mA capability, short circuit protected. This rail provides power to the drive electronics, The drive will not function while this rail is shorted. If it is used for external circuitry please ensure that it is buffered from possible interference by inserting a series resistor as close as possible to T63. A value between 10 and 100 Ohms should be adequate.

T64 XIP alternative speed input via RL2 de-energised. Also on terminal 18. 0 to +10V for 0 to 100% speed demand. Summing input. note: for - demand, the internal ramp clamps at -5%. The JOG SPEED preset (0 to +1V) is connected to this terminal via a 470K resistor.

T65 -IP ramped aux inverting input -10V represents 100%. 100K input impedance summing input. Note: for - demand, the internal ramp clamps at -5%. Also on T20.

T66 IP ramped auxiliary input 10V represents 100%. 50K input impedance summing input. Also on T19.

T67 +24 volt rail. Unregulated, unprotected. may vary between 35V and 18V depending on loading and supply. Output capability 25mA. Do not overload or short this rail.

T68 COM common. 0V for drive electronics. Also on T5, T8, T15, T27 and T58. (one of these must be earthed for protective class 1)

T69 IOM Modulus armature current output. 0 to +5V for 0 to 100% armature current. 1K series buffer resistor.

T70 IP Direct speed input. 0 to +10V for 0 to +100% demand. This input by-passes the setpoint ramp circuit. It is connected to the speed jumper pin so that the direct speed input may be used if the drive is in torque mode. (470K Ohms input impedance)

WARNING. TAKE CARE NOT TO TOUCH ANY HIGH POTENTIAL PARTS OF THE UNIT ON THE LOWER POWER CARD WHILST PROBING THESE TERMINALS.



Anticlockwise



Midway



Clockwise

Rotate clockwise to increase speed. Change range with S3 and S4.

Rotate clockwise to increase minimum speed. Use to adjust 4-20mA loop burden resistor between 0 and 360 Ohms if 4-20mA mode is selected.

Rotate clockwise to increase acceleration. Span is 0.5 to 30 seconds with S7 off. Span is 1 to 60 seconds with S7 on.

Rotate clockwise to increase deceleration, note, the limit is determined by the natural coast down rate. (see spec. for models with regen braking)

Rotate clockwise to increase response. Excessive rotation may cause instability.

Rotate clockwise to increase level of positive zero speed adjustment, and anti-clockwise for negative adjustment. (+/-5% span)

Rotate clockwise to increase current limit. Eg 50% clockwise rotation gives 50% current limit.

TORQUE OR SPEED MODE JUMPER. This jumper alters the function of the AUX input on terminal 6.

2Q TORQUE: 0 to +10V for 0 to 100% positive current limit
SPEED: 0 to +10V for 0 to 100%.

4-20mA. Link both and terminal 2 is input, 5 return. MIN SPEED to set zero. Link lower pair of pads only for 0 - 20mA loop signals

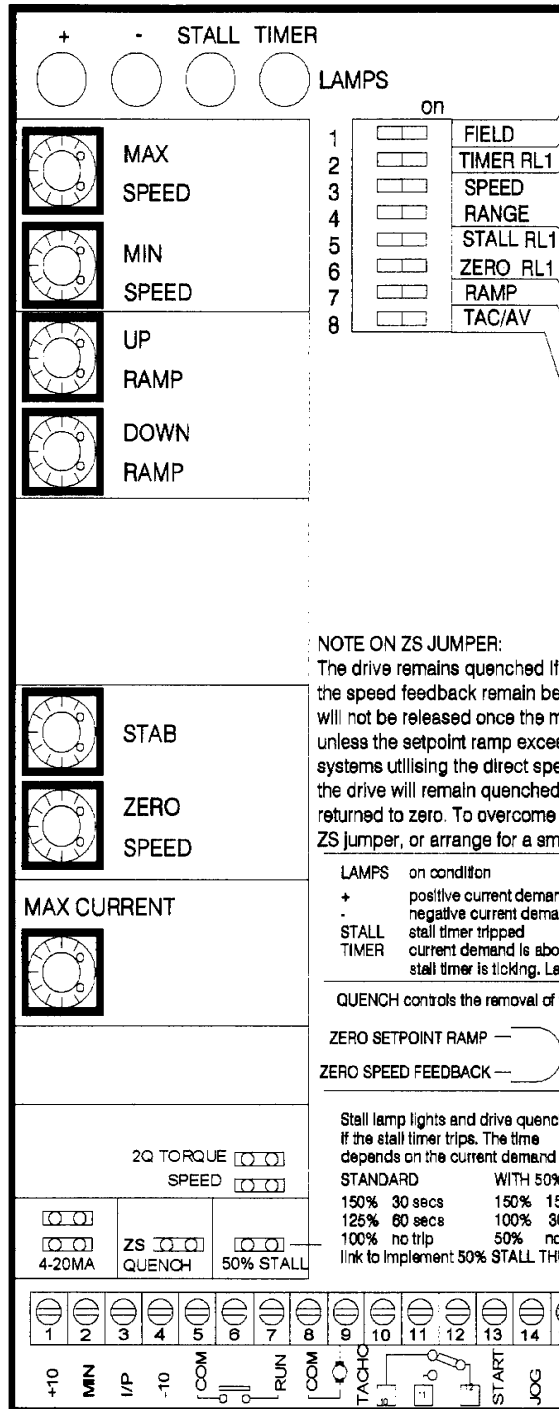

S1 sets the motor field control mode. When off, the field current is set by the CURRENT REGULATION preset. When on, the automatic field weakening mode is selected, and the AV limit preset becomes active. (see FIELD SET UP section 3)

S2 allows the relay on 10, 11, 12 to be energised by the STALL TIMER when on, the relay remains energised for current demand levels below 105% of preset limit.

These two switches allow four maximum feedback voltage ranges to be selected. Use the MAX SPEED PRESET to adjust within the range. The drive will control from 0V to the selected maximum for a 0-10V input.

S3	off	S3	on	S3	off	S3	on
S4	off	S4	off	S4	on	S4	on
30-60V		60-125V		125-250V		250 to 500V	

S2 S5 and S6 allow the function of the relay on 10, 11, 12 to be selected.

S5 when on, the relay remains energised until a stall condition occurs.

S6 when on, the relay remains energised for speeds above 1% of full scale.

NB. with both switches on the relay de-energises when a stall condition has occurred AND the speed has fallen below 1% of full scale.

S7 LONG RAMP when off the speed ramp adjustment range is approx 1 to 30 seconds, when on, the range is increased to 1 to 60 seconds.

S8 This switch allows the selection of the source of speed feedback. When on, the ARMATURE VOLTAGE is selected. When off, a tacho. Calculate the maximum feedback voltage from the chosen source in order to set switches S3, S4. e.g Tacho 180V at full speed S3 off, S4 on, S8 off.
Armature voltage 460V, armature voltage feedback, S3 on, S4 on, S8 on.

NOTE ON ZS JUMPER:
The drive remains quenched if the setpoint ramp AND the speed feedback remain below 1%. The quench will not be released once the motor has stopped unless the setpoint ramp exceeds 1%. Hence for systems utilising the direct speed input on terminal 6, the drive will remain quenched once the speed has returned to zero. To overcome this, either remove the ZS jumper, or arrange for a small ramp setpoint.

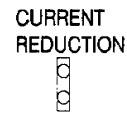
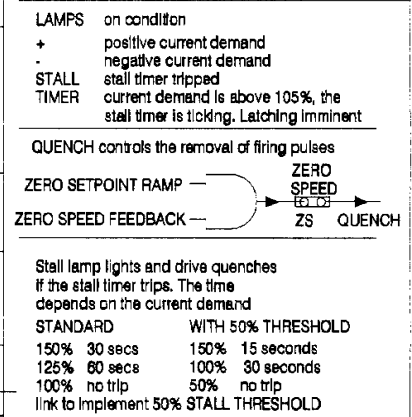

NOTE: this preset is not normally adjusted. Rotate clockwise to increase the response of the current loop. Excessive rotation may lead to unwanted current instability. The standard setting is fully anticlockwise. Refer to section 3.

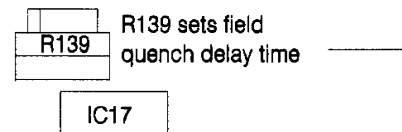

clockwise rotation to increase JOG SPEED reference on T18/T64. (maximum 1V)

The relay RL1 on terminals 10/11/12 is shown here in a de-energised state

Further information on Field and tacho functions on 3.8/9

1) CORRECT OPERATION OF MAIN CONTACTOR 2) CORRECT SCALING OF SPEED AND CURRENT 3) ARMATURE WIRING FIELD WIRING 4) SPEED DEMAND, CURRENT DEMAND. 5) RUN LINE, START STOP, POWER ON/OFF 6) SAFETY PRECAUTIONS I

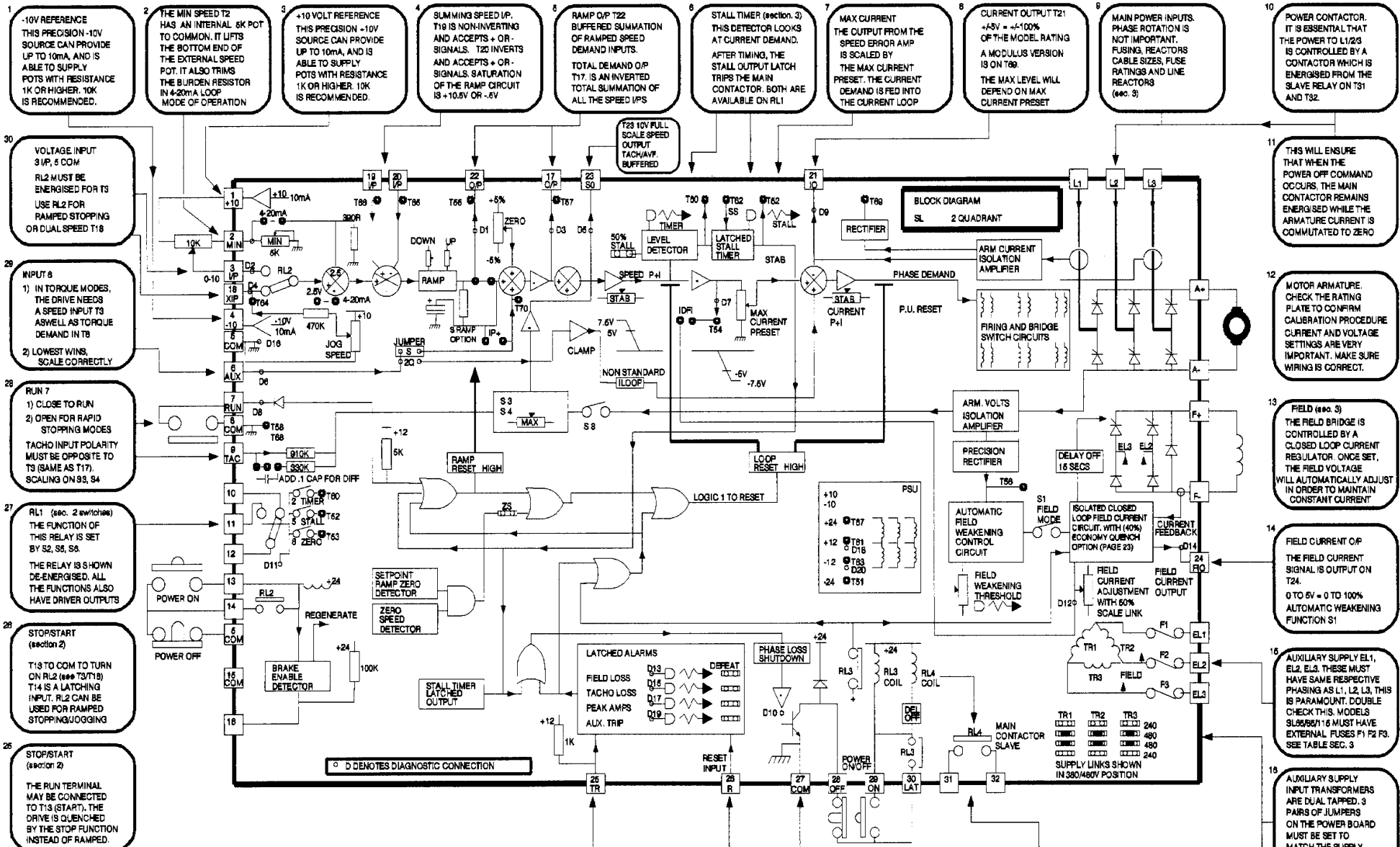

1) -10V REFERENCE THIS PRECISION -10V SOURCE CAN PROVIDE UP TO 10mA, AND IS ABLE TO SUPPLY POTS WITH RESISTANCE 1K OR HIGHER. 10K IS RECOMMENDED.

2) THE MIN SPEED T2 HAS AN INTERNAL 5K POT TO COMMON. IT LIFTS THE BOTTOM END OF THE EXTERNAL SPEED POT. IT ALSO TRIMS THE BURDEN RESISTOR IN 4-20mA LOOP MODE OF OPERATION

3) +10VOLT REFERENCE THIS PRECISION +10V SOURCE CAN PROVIDE UP TO 10mA, AND IS ABLE TO SUPPLY POTS WITH RESISTANCE 1K OR HIGHER. 10K IS RECOMMENDED.

4) SUMMING SPEED I/P. T19 IS NON-INVERTING AND ACCEPTS + OR - SIGNALS. T20 INVERTS AND ACCEPTS + OR - SIGNALS. SATURATION OF THE RAMP CIRCUIT IS +10.6V OR -6V

5) RAMP O/P T22 BUFFERED SUMMATION OF RAMPED SPEED DEMAND INPUTS. TOTAL DEMAND O/P T17. IS AN INVERTED TOTAL SUMMATION OF ALL THE SPEED I/Ps

6) STALL TIMER (section 3) THIS DETECTOR LOOKS AT CURRENT DEMAND. AFTER TIMING, THE STALL OUTPUT LATCH TRIPS THE MAIN CONTACTOR. BOTH ARE AVAILABLE ON RL1

7) MAX CURRENT THE OUTPUT FROM THE SPEED ERROR AMP IS SCALED BY THE MAX CURRENT PRESET. THE CURRENT DEMAND IS FED INTO THE CURRENT LOOP

8) CURRENT OUTPUT T21 +5V = +100% OF THE MODEL RATING A MODULUS VERSION IS ON T69. THE MAX LEVEL WILL DEPEND ON MAX CURRENT PRESET

9) MAIN POWER INPUTS. PHASE ROTATION IS NOT IMPORTANT. FUSING, REACTORS, CABLE SIZES, FUSE RATINGS AND LINE REACTORS (sec. 3)

10) POWER CONTACTOR. IT IS ESSENTIAL THAT THE POWER TO L1/2/3 IS CONTROLLED BY A CONTACTOR WHICH IS ENERGISED FROM THE SLAVE RELAY ON T31 AND T32.

11) THIS WILL ENSURE THAT WHEN THE POWER OFF COMMAND OCCURS, THE MAIN CONTACTOR REMAINS ENERGISED WHILE THE ARMATURE CURRENT IS COMMUTATED TO ZERO

12) MOTOR ARMATURE. CHECK THE RATING PLATE TO CONFIRM CALIBRATION PROCEDURE CURRENT AND VOLTAGE SETTINGS ARE VERY IMPORTANT. MAKE SURE WIRING IS CORRECT.

13) FIELD (sec. 3) THE FIELD BRIDGE IS CONTROLLED BY A CLOSED LOOP CURRENT REGULATOR. ONCE SET, THE FIELD VOLTAGE WILL AUTOMATICALLY ADJUST IN ORDER TO MAINTAIN CONSTANT CURRENT

14) FIELD CURRENT O/P THE FIELD CURRENT SIGNAL IS OUTPUT ON T24. 0 TO 5V = 0 TO 100% AUTOMATIC WEAKENING FUNCTION S1

15) AUXILIARY SUPPLY EL1, EL2, EL3. THESE MUST HAVE SAME RESPECTIVE PHASING AS L1, L2, L3. THIS IS PARAMOUNT. DOUBLE CHECK THIS. MODELS SLR28/116 MUST HAVE EXTERNAL FUSES F1 F2 F3. SEE TABLE SEC. 3

16) AUXILIARY SUPPLY INPUT TRANSFORMERS ARE DUAL TAPPED. 3 PAIRS OF JUMPERS ON THE POWER BOARD MUST BE SET TO MATCH THE SUPPLY. (See INITIAL POWER UP section 2)

17) NOTE. THE MAIN POWER INPUTS NEED NOT BE THE SAME AS THE AUXILIARY SUPPLY AS LONG AS THEY HAVE THE SAME PHASING. EG BATTERY CHARGING SYSTEMS

18) ON MODELS UP TO SL60 THE AUXILIARY SUPPLY IS FUSED INTERNALLY (sec. 3 for rating table) FUSE HOLDERS ARE AT THE TOP RIGHT HAND CORNER OF THE UNIT. F2 AND F3 ALSO FEED THE FIELD BRIDGE

19) MAIN CONTACTOR SLAVE T31 T32. THIS MUST BE USED TO CONTROL THE MAIN POWER SUPPLY CONTACTOR. WARNINGS, DAMAGE MAY OTHERWISE OCCUR USE T28 T29 T30

20) POWER ON/OFF RL3 ENERGISED BY T29 RL3 LATCHED BY T30 RL3 DE-ENERGISED T28 RL4 IS DELAYED OFF TO ALLOW CURRENT COMMUTATION

21) THIS TRANSISTOR IS TURNED OFF BY A STALL OR ALARM CONDITION. IT OPENS THE POWER OFF LINE WHICH CAUSES THE MAIN CONTACTOR TO DE-ENERGISE. NOTE. ALARMS LATCH. T28 CAN DRIVE 24V 25mA RELAY

22) ALARMS (sec. 3) CLOSE T26 TO COM TO RESET. (EXCEPT PEAK AMPS AND STALL) AUX. TRIP ON T26 FOR THERMISTOR INPUT. ALARMS MAY BE DEFEATED BY JUMPER

23) ZS JUMPER (sec. 2) THIS IS USED TO QUENCH THE DRIVE AT ZERO SPEED. THE THRESHOLD IS 1%. TO PREVENT QUENCHING REMOVE THE ZS JUMPER

24) IF THE ZS JUMPER IS IN POSITION, AND THE SPEED INPUT RAMP IS UNUSED, THE FIRING PULSES WILL NOT BE RELEASED. PARK THE JUMPER ON 1 PIN TO RUN

25) STOP/START (section 2) T13 TO COM TO TURN ON RL2 (see T3/T18) T14 IS A LATCHING INPUT. RL2 CAN BE USED FOR RAMPED STOPPING/JOGGING

26) STOP/START (section 2) THE RUN TERMINAL MAY BE CONNECTED TO T13 (START). THE DRIVE IS QUENCHED BY THE STOP FUNCTION INSTEAD OF RAMPED.

27) RL1 (sec. 2 switches) THE FUNCTION OF THIS RELAY IS SET BY S2, S5, S6. THE RELAY IS SHOWN DE-ENERGISED. ALL THE FUNCTIONS ALSO HAVE DRIVER OUTPUTS

28) RUN 7 1) CLOSE TO RUN 2) OPEN FOR RAPID STOPPING MODES TACHO INPUT POLARITY MUST BE OPPOSITE TO T3 (SAME AS T17). SCALING ON S3, S4

29) INPUT 8 1) IN TORQUE MODES, THE DRIVE NEEDS A SPEED INPUT T3 AS WELL AS TORQUE DEMAND IN T6 2) LOWEST WINS. SCALE CORRECTLY

30) VOLTAGE INPUT 3 I/P, 5 COM RL2 MUST BE ENERGISED FOR T3 USE RL2 FOR RAMPED STOPPING OR DUAL SPEED T18

THE COMMENT BOXES SURROUNDING THE BLOCK DIAGRAM ARE INTENDED TO GIVE A BRIEF DESCRIPTION ONLY OF THE KEY FEATURES. PLEASE REFER TO THE MANUAL FOR A MORE COMPLETE DESCRIPTION. THE CHECKLIST AT THE TOP OF THE PAGE HIGHLIGHTS THE KEY AREAS OF CONCERN FOR COMMISSIONING.

BASIC APPLICATION

This diagram shows a simple form of speed control wiring. Please refer to section 5 for more complex functions.

For applications in the European Union special precautions may have to be taken for EMC purposes. A line filter may be required (shown as dotted box) in non-industrial installations, and EMC guidelines followed. See section 5.18.

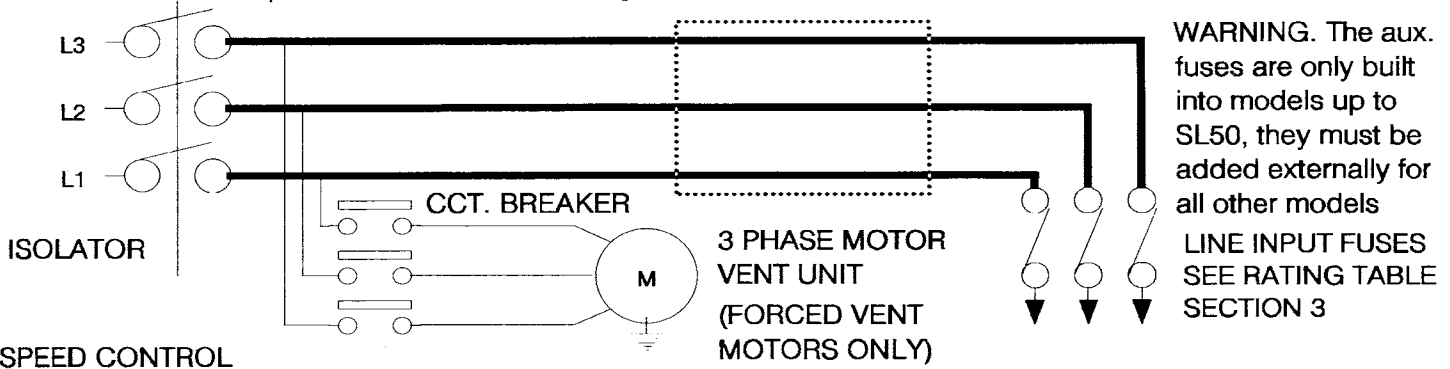

WARNING. The aux. fuses are only built into models up to SL50, they must be added externally for all other models
 LINE INPUT FUSES SEE RATING TABLE SECTION 3

SPEED CONTROL

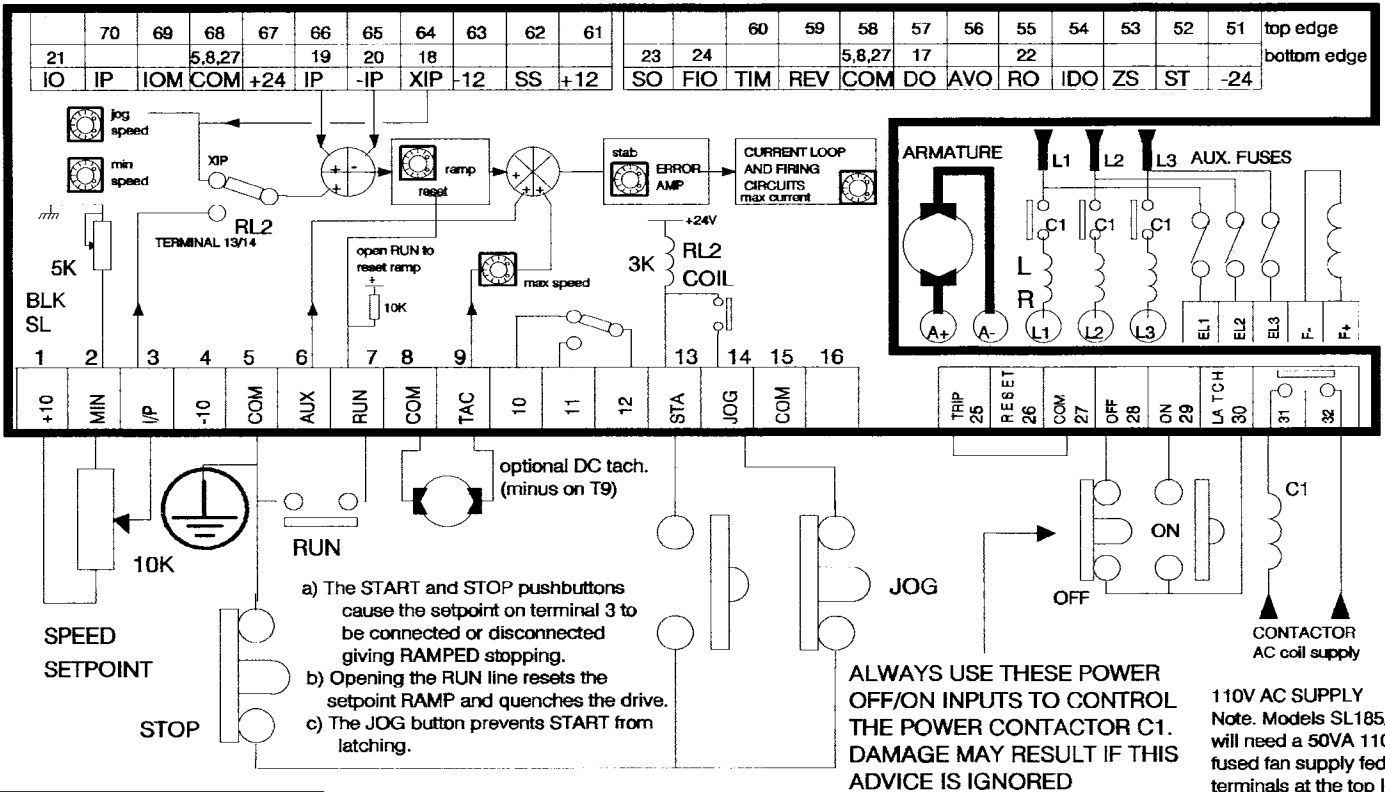

LINE REACTOR

All thyristor 3 phase convertors commutate the load current between devices and lines. During the process of commutation which lasts approximately 100 microseconds, notching will appear on the incoming supply lines. To prevent possible disturbance to the supply it is necessary to use a 3 phase LINE REACTOR between the POWER connections of the drive and the supply lines. Bardac has developed a range of Line Reactors to suit all models in the SL range. It is essential that all three phase drive systems incorporate the appropriate Line Reactor. See Rating Table and Dimensions section 3.

FUSING AND EARTHING

IMPORTANT WARNING



INTERNATIONAL GROUND SYMBOL (BLACK ON GREEN BACKGROUND) IDENTIFIES DRIVE EARTH TERMINAL.

All incoming main power supply connections must be protected by the correct fuses (warranty requirement). A DC semi-conductor armature fuse may be required for systems with inertial loads and regenerative braking. A substantial earth connection must be made to the earth terminal of the drive. (SEE RATING TABLE sec. 3). **SAFETY EARTHING.** The isolated control common (0V) must be connected to protective earth to ensure the equipment meets protective class 1 criteria. Refer to section 5.18 for analogue signal earthing details.

POWER ON/POWER OFF

IMPORTANT WARNING

The POWER ON/OFF control facilities (T28/29) integral to the drive must be used to energise the main contactor. This ensures correct power sequencing. The armature current may not be commutated to zero correctly, and could cause non-warranty damage if this advice is ignored. If safety codes mandate external contactor control, then the POWER OFF function on T28/29 must be initiated 100mS prior to contactor opening to avoid damage. (See application 5.7)

This is a summary of the essential parameters that should be checked prior to allowing power to the motor. You must be able to put a tick against every section. Failure to comply with these requirements may cause incorrect functioning or damage to the drive and/or installation and will invalidate any warranty.

tick when checked

POWER ENGINEERING

- 1) All external fuses must be of the correct rating and type. The I²t rating must be less than the rating specified in the rating table. This includes main and auxiliary fuses.
- 2) Check the 3 phase auxiliary supply voltage is compatible with the drive voltage rating set up. (dual range voltage selectors on power board)
- 3) Check the 3 phase auxiliary supply phasing on EL1/2/3 equates to the phasing of the main stack supply on L1/2/3.
- 4) The drive and 3 phase supply current and voltage ratings, should be compatible with the motor and load requirements. (both armature and field, current and voltage).
- 5) The cables and termination should be rated to carry the rated current with no more than a 25C temperature rise, and all terminations should be tight.
- 6) The main contactor must be operated by the slave contact on terminal 31 and 32, and the correct operation of the slave verified prior to applying power to the motor .
- 7) The wiring should be checked for short circuit faults. AC power to ground, signal and control. DC power to ground, signal and control. Signal to control and ground. Disconnect the drive for wiring tests using a megger.
- 8) The engineering standards employed must comply with any local, national or international codes in force. Safety requirements take priority.
- 9) If the load is inertial and regenerative braking is employed, then a DC rated armature fuse with the correct I²t rating must be in series with the motor armature.
- 10) A substantial protective earth connection in accordance with relevant codes should be made to the terminal provided.
- 11) A protective earth connection must be made to the control COMMON (T5) to ensure that the installation complies with protective class 1 requirements.

CHECKED	<input checked="" type="checkbox"/>
CHECKED	<input type="checkbox"/>
CHECKED	<input type="checkbox"/>
CHECKED	<input type="checkbox"/>
CHECKED	<input type="checkbox"/>
CHECKED	<input type="checkbox"/>
CHECKED	<input type="checkbox"/>
CHECKED	<input type="checkbox"/>
CHECKED	<input type="checkbox"/>

MECHANICAL ENGINEERING

- 1) The motor and load if fitted must be free to rotate without causing damage or injury, even in the event of incorrect rotation direction, or loss of control.
- 2) The emergency stopping and safety procedure, including local and remote actuators must be checked prior to applying power to the motor.
- 3) The installation must be clean and free of debris such as swarf, clippings, tools etc. The enclosure must be adequately ventilated with clean dry filtered air.

CHECKED	<input type="checkbox"/>
CHECKED	<input type="checkbox"/>
CHECKED	<input type="checkbox"/>

CONTROL ENGINEERING COMMISSIONING PROCEDURES

- 1) The speed and/or torque references should be traced through to the current demand stage. See section 2
- 2) The drive should be set up to run in armature voltage feedback mode initially to enable the polarity and amplitude of the tacho (if fitted) signal to be found. Section 2.
- 3) For systems with multiple control elements and or complex interactive loop components, initially run the drive in a basic stand alone arrangement to verify performance
- 4) For systems using field weakening start with a basic AVF mode to verify tacho. Then introduce field weakening only after careful calibration. Section 3
- 5) For systems employing torque control it is recommended to set up in basic speed mode first in order to establish correct speed loop functioning and calibration.
 Note:- With the torque/speed jumper in torque mode the drive will not run without a torque demand on terminal 6.
- 6) When pre-testing systems without a motor being available it is possible to use 2 mains light bulbs in series as a dummy load for the armature in AVF mode, or the field. This will allow the essential static operation to be verified, and approximate scaling to be accomplished.

PLEASE READ THROUGH THE SET UP PROCEDURE PRIOR TO COMMENCING

Part 1. Visual checklist for complete installation including drive.

Part 2. Initial power up with main contactor disabled.

Part 3. Application of power to motor and running checks.

IMPORTANT. FIRST ISOLATE THE SYSTEM AND DISABLE THE MAIN CONTACTOR. (REMOVE CONTROL SUPPLY FUSE)

PART1 VISUAL CHECK

CHECKING INSTALLATION

All external wiring circuits POWER, CONTROL AND MOTOR (disconnect the controller prior to checking with a megger)

For damage to equipment

For loose ends, clippings, swarf etc. lodged in equipment.

INSPECT MOTOR

Inspect the motor, brushes, commutator, free rotation of motor and vent fan (if fitted).

ENSURE that rotation of the machinery in either direction will not cause a hazard and that nobody else working on the machine can be affected by motor rotation or powering up.

Check the tacho coupling if fitted. The coupling should be stiff in the rotating axis with no slippage on the shafts.

PHASE SEQUENCE

The incoming phase rotation is not important but the phase of EL1 EL2 EL3 must be the same as L1 L2 L3. Check that the incoming line feeding EL1 also feeds L1 (usually through contactor and line reactor). Repeat check for EL2/L2 and EL3/L3. Take care if transformers are between the stack and auxiliary supply that there is no phase shift between the input and output of the transformer. It must be delta-delta OR star-star OR star connected auto.

PRESET CHECKING

INITIAL SETTING OF USER PRESETS. A complete description of the customer presets may be found in section 1. The unit is shipped to run with armature voltage feedback at 460V full speed, and full current limit. The speed/torque jumper is in torque mode.(note, this is a precaution for safe commissioning). For complete commissioning commence with the presets set as follows:

MAX SPEED. fully anticlockwise
MIN SPEED. fully anticlockwise
UP RAMP. fully anticlockwise
DOWN RAMP. fully anticlockwise
SPEED STAB. midway
ZERO SPEED. midway
MAX CURRENT. fully anticlockwise
FIELD CURRENT. fully anticlockwise
JOG SPEED. fully anticlockwise

The commissioning procedure described in this section will take you through the adjustment of the customer functions and presets in a methodical step by step process. This procedure applies to a basic installation. For complex or multi drive installations it may be advisable to initially provide a local setpoint pot and other local controls to enable commissioning of each drive in turn before proceeding to the final system. This applies to torque control and field weakening installations also.

FUNCTION SWITCH checking. Switches S1 to S8.

SWITCH 1

FIELD CONTROL switch. When OFF this sets the field control circuit to standard current regulation. For systems requiring field weakening, it is necessary to commission the system initially in the standard mode (OFF), then proceed to the automatic weakening mode with the switch ON. Refer to section 3 for field set up description.

SWITCH 2

When ON. de-energises relay 1 (T10/11/12) when stall timer commences. (See S5, S6 below)

SWITCH 3 and 4

MAX SPEED FEEDBACK SCALING. (note. This is the FULL SCALE 100% SPEED range selection)

TACHO.	3,4	off	30V	-	60V
or	3	on	60V	-	125V
ARM	4	on	125V	-	250V
VOLTS	3,4	on	250V	-	500V

Note.

For low voltage tachometers there is a 25% scaling function. See 3.8. This will reduce all the ranges to 25% of the standard levels.

The MAX SPEED preset gives fine adjustment within the switch range.

FOR SYSTEMS UTILISING TACHO FEEDBACK, THE SAFEST PROCEDURE IS TO COMMISSION THE DRIVE FOR THE FIRST TIME IN ARMATURE VOLTAGE FEEDBACK MODE, WITH THE TACHOMETER CONNECTION REMOVED FROM TERMINAL 9. THIS WILL PREVENT A RUN-AWAY MOTOR IN THE EVENT OF INCORRECT TACHO POLARITY OR COUPLING. IT ALSO ALLOWS THE FULL SCALE TACHO VOLTAGE TO BE MEASURED PRIOR TO USE.

THE SUGGESTED STARTING POINT IS: S3 ON, S4 ON, MAX SPEED FULLY ANTI-CLOCKWISE. GIVES 250V MAXIMUM ARMATURE VOLTAGE.

Note. If a tachogenerator is used it must be a DC type.

SWITCH 2, 5, 6

RELAY 1. (voltage free changeover relay on T10/11/12). Switches 2, 5 and 6 control the function of Relay 1. If more than one function is selected then these functions are logically ANDED.

2,5,6 off	Relay 1 permanently de-energised
2 on, 5,6 off	Relay 1 de-energises when stall timer commences (see section 3 for stall timer description)
5 on, 2,6 off	Relay 1 de-energises on stall condition
6 on, 2,5 off	Relay 1 de-energises at zero speed
5,6 on, 2 off	Relay 1 de-energises on stall condition AND speed = zero

SWITCH 7

Switch 7 determines the maximum duration of the setpoint ramp.

7 off	setpoint ramp range 0.5 - 30 secs.
7 on	setpoint ramp range 1 - 60 secs.

SWITCH 8

Switch 8 selects the method of feedback. When first commissioning start in Armature Voltage Feedback (AVF). *Ensure tacho is disconnected from terminal 9 when using armature voltage feedback.*

8 off	OFF for Tacho Feedback
8 on	ON for Armature voltage feedback

To locate the jumpers and links refer to 1.5, 3.8 and 3.9.

TORQUE/SPEED JUMPER

The torque control operates by clamping the current demand from the speed loop, see block diagram. Hence the loop with the lower demand has control. This allows torque control with overspeed limiting, or speed control with over torque limiting. A full description of this function is given in section 3. It is recommended to set the drive up initially in SPEED mode and then when the speed operation is satisfactory, to commence the TORQUE commissioning. Temporarily park the jumper on one pin to disable the TORQUE mode.

50% STALL THRESHOLD. A full description of this function is given in section 3.7 Link the solder pads if the function is required.

ZS JUMPER

This jumper enables the firing pulses to be removed when the speed and setpoint remain below 1%. Refer to the BLOCK DIAGRAM OF DRIVE INHIBIT CIRCUIT on 3.3, and description of RAMP FUNCTIONS on 3.3, 3.4 in order to choose the correct mode for your application.

S RAMP

The S RAMP function is an option that allows the shape of the speed demand ramp to be modified.

To implement the S RAMP function

- 1) link the solder pads marked IP+
- 2) break the solder pads marked S R (de-solder)
- 3) add 10uF electrolytic capacitor. SC
- 4) add a 240K resistor

Note this function utilises the auxiliary input which also appears on terminal 70 and terminal 6. Park the speed jumper on one pin to disconnect terminal 6. (the length of the S shaped tails is roughly proportional to the capacitor size. Other values may be used if desired. The 10uF caps give tails of 1 second approximately)
The S ramp output can be seen inverted on terminals 17 and 57.

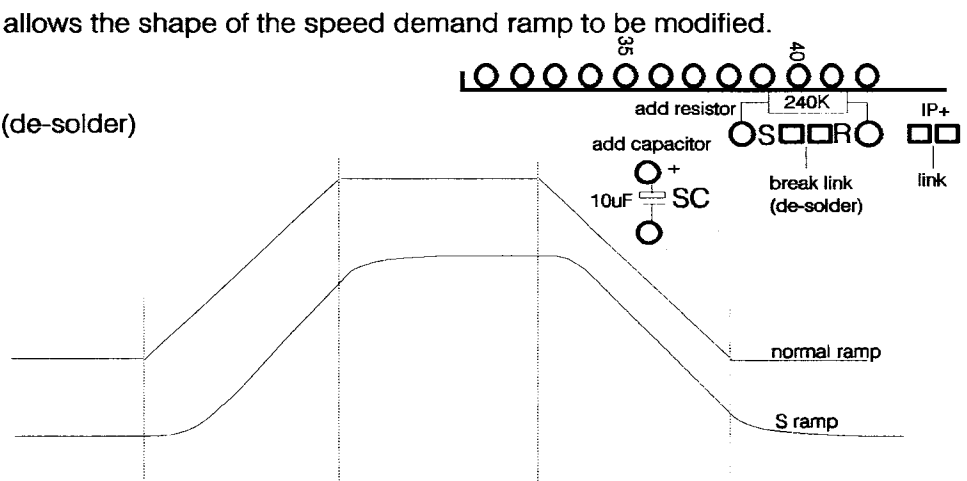

4-20mA SIGNAL INPUT LINK.

Link the 2 pairs of solder pads to allow terminal 2 to become the loop input, terminal 5 the return and adjust MIN SPEED to change the gain. With the signal loop providing 20mA, adjust MIN SPEED to give +10V at RO on T22. Initial setting suggestion using Ohmmeter. With no connection to T 2 and the links made, adjust the MIN SPEED preset until the resistance between T2 and T5 measures 250 Ohms. (the adjustment range will be 0 to 360 Ohms). For 0-20mA signals link only the lower pair of solder pads.

ALARM DEFEAT

The drive has 4 fast latched alarms:

Field loss	Tacho loss	Peak amps	Aux. trip
------------	------------	-----------	-----------

If any one of these is triggered, then the drive is immediately inhibited and the main contactor is de-energised. Any alarm may be defeated by linking the appropriate jumper. A full description is given in section 3.

THERMISTOR or MICROTHERM.

Terminal 25 is an external trip input. If the resistance to 0V exceeds 2.0 KOhms, then the AUX. TRIP ALARM will trip the main CONTACTOR. This may be used for field and interpole motor protection devices. If not used, the feature must be inhibited by connecting T25 to T27 (COM). The alarm will not trip for resistance to 0V less than 200 Ohms.

SAFETY CONSIDERATIONS

Before proceeding to the next stages which involve applying power to the drive, check the following items:

All relevant safety precautions have been observed.

There must be no unqualified or unauthorised personnel allowed near the drive or machine or load.

Do not work on the drive without safety assistance.

READ THE IMPORTANT OPERATING CONSIDERATIONS IN SECTION 1

PART 2 INITIAL POWER UP

The unit is now ready to receive auxiliary power. At this stage it is necessary to use a voltmeter to measure certain signals.

DISABLE CONTACTOR

Before applying power, check that the main CONTACTOR is still disabled. If there is any doubt about the integrity of a particular system, insert a high wattage resistor in series with the armature e.g. a fire element. The following checks will involve measuring certain signals with power applied to the drive.

APPLYING POWER

Verify that the supply jumpers match your supply. Also check the drive rating label. The six supply jumpers can be seen at the lower right hand side of the power board, see section 3 (maintenance) for details on removing top card. Note, new units are shipped from the factory with the jumpers in the STANDARD position (380-480V).

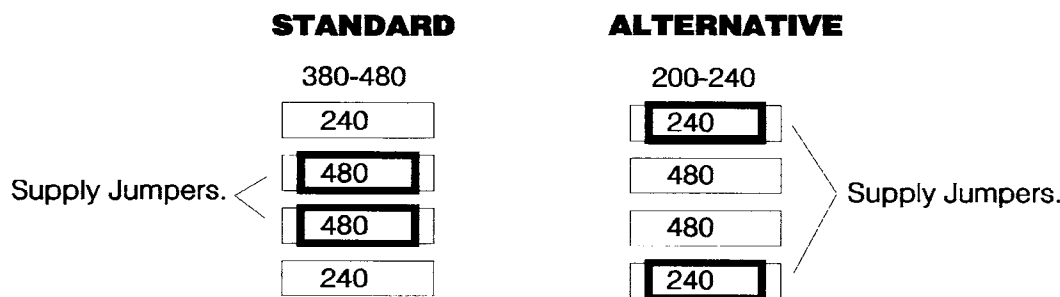

THE FIRST TIME YOU APPLY POWER BE READY TO TURN OFF QUICKLY IN THE EVENT OF A PROBLEM.

- 1) Apply Power.
- 2) Observe illuminated bridge lamp.
- 3) All alarm lamps should be off.
- 4) Check the following voltages.

All 3 auxiliary phases should match model and tap selection.

EL1-EL2 Check that the correct phase to phase AC VOLTAGES
EL2-EL3 are present. 3 identical readings in the range of
EL3-EL1 either 200-240V or 380-480V.

10 VOLT REFERENCES

The remaining measurements are taken with respect to 0V (com)

T4 -10V
T1 +10V
T3 +10V to 0V adjustable by speed demand pot. Leave at 0 volts.

POWER ON / OFF CIRCUIT

The next stage is to check the POWER ON/POWER OFF circuit. The FIELD excitation will be activated during this process. See section 3 (Field control) to familiarise yourself with the available field control functions and presets. **WARNING. ENSURE THE MAIN CONTACTOR IS STILL DISABLED.**

When the POWER ON function is activated, the field voltage will increase to provide the preset field current..

When POWER OFF is selected the field voltage will stay on for a further 15 seconds and then go off. If the field economy mode is selected the field will reduce to 40% of preset field current. If the MIN FIELD (see 3.8) option is fitted then the field output voltage will not go below 20V approx.(even with POWER OFF selected)

Operate the POWER ON/POWER OFF buttons and check that the slave (T31-T32) opens and shuts .

The Slave Contact lamp comes on when the contact closes. The SLAVE CONTACT lamp is in the top right hand corner of the control card. Note, if any alarm lamp is on, the POWER ON function is inhibited. On the fan cooled units check air is flowing freely due to the fan action. (The fans are only energised during a POWER ON sequence) Check that any other contacts in the POWER OFF line operate correctly.

With POWER ON active, adjust the field, see section 3 (Field control).

The next stage will establish that a current demand signal is present. To do this the run contact must be temporarily shorted (T5-T7) and START (T5-T13). Note, the STALL lamp may come on during this sequence of tests, this is normal. To prevent this from causing interruptions, temporarily put the TORQUE jumper in the 2Q TORQUE position, activate POWER ON.

Increase the the speed demand and observe the RAMP (T22). This should follow the setpoint at the slowest rate. The speed demand may be derived from numerous sources depending on application, and the analogue processing inputs (T18, T19, T20) may be utilised. Refer to the BLOCK DIAGRAM and follow the signal path. NOTE. the resultant RAMP output may be the bi-polar summation of more than one input. More accurate adjustment of the up and down ramps is possible now.

Check that an inverted version of the RAMP output appears on the TOTAL SETPOINT OUTPUT (T17). If the S RAMP function has been implemented, the inverted output can be monitored on T17 with an oscilloscope to verify that the S ramp function is giving the correct shape to the setpoint changes.



Reduce speed reference to zero and re-park TORQUE jumper on one pin to release current demand.

After being satisfied that the the speed demand is functioning, it is possible to check the next stage. This compares the speed demand with the speed feedback and integrates the error to produce a voltage signal, (current demand IDO on T54, this is also torque demand). The signal can be made to integrate up by arranging for a small speed demand. Increase speed reference by a small amount and observe current demand on T 54, 0 to -7.5V represents 0 to 150%. (note that a larger reference results in a more rapid rise of IDO). Open the external RUN contact if you want to reset the current demand.

TIMER LAMP

The TIMER lamp should come on as the current demand exceeds -5.25V (105%).

STALL LAMP

The stall lamp should come on approximately 30 seconds later causing the slave contact to drop out and the TIMER lamp to latch on.

The STALL condition may be reset by removing and re-applying the auxiliary power, or momentarily shorting T62 to T61.

TORQUE CONTROL

For systems involving TORQUE control it should be possible at this stage to establish correct operation of a 0 to +10V input to T6. With the torque link in 2Q TORQUE position and a speed demand input (+) the current demand signal should be controllable between 0 to - 5V.

Operating the POWER OFF button or opening the RUN line will reset the ramp and current demand circuits.

PART 3 APPLICATION OF POWER TO THE MOTOR

Turn off all power and refit the MAIN CONTACTOR COIL SUPPLY FUSE..

SLAVE RELAY

The maximum switching capability of the slave relay is 1A at 250V AC. (The CSA rating is 1A at 125V AC). For contactor coils with higher ratings, an intermediate slave relay should be utilised. A coil suppressor should be fitted to the main CONTACTOR. and any intermediate relay.

Ensure all speed demands are set to minimum. Turn on the supply to the drive. Press the POWER ON button. The main CONTACTOR should pull in.

Press the POWER OFF button. The main CONTACTOR should drop out.

DAMAGE WARNING

WARNING. The main contactor should not be operated by any means other than the internal contactor control circuit provided. Any warranty will be invalidated if this warning is not heeded. PERSONNEL SAFETY should always take priority in system implementation. Refer to manufacturer for advice if this damage warning can not be implemented due to safety considerations.

DO NOT PROCEED FURTHER UNLESS THE POWER ON/OFF CIRCUITS AND CONTACTOR OPERATE CORRECTLY.

POWER ON

POWER ON and close the RUN contact.

LOW SPEED CHECK

Press START and then set the speed demand to about 5%. Then slowly rotate the MAX CURRENT clockwise to about 20%. The motor should rotate at 5% of full speed (initially full speed is 250V on armature). If the direction of rotation is incorrect, POWER OFF and remove the supply to the drive. Swap the field connections. Continue as before and progressively increase the speed DEMAND to 50%. During this stage an increase in MAX CURRENT may be required if the TIMER lamp remains on. Set the speed demand to zero for the next step.

ZERO SPEED

Temporarily remove the ZS jumper for accurate ZERO SPEED calibration. Adjust the ZERO SPEED preset clockwise until the motor just turns, then back it off until the motor just stops. Replace the ZS jumper. (This step may need repeating for systems with tacho feedback)

MAX SPEED

Increase the speed demand to 100% and adjust MAX SPEED to give the desired full speed. **DO NOT ALLOW ARMATURE VOLTAGE TO EXCEED RATING.** Monitor the armature voltage output on T56. 0 to 10V for 0 to 500V AV. The rating will be found on the motor rating plate. If the motor rating is excessive for the supply used, then do not exceed the ratings on 1.2.

FOR SYSTEMS WITH TACHO FEEDBACK. With the motor at the correct max speed for the application (this need not be the maximum capable speed) check the tacho voltage and polarity. STOP THE DRIVE and POWER OFF. Re-connect the tacho with the -ve wire to T9 and +ve to T8 (COM). Select S3, S4 range to suit tacho voltage. Turn off S8. See worked example on 3.12. For low voltage tachos, the full scale voltage ranges can be reduced to 25% by making a link on the control card. There is also a tacho differential mode option. (see layout on 3.8). Re-run the drive at a low speed demand to verify tacho connection. Recalibrate the speed, first at 50% demand to give approximately 50% speed using the MAX SPEED preset. Then accurately at 100% demand.

MIN SPEED and JOG SPEED

Reduce the speed demand to zero and rotate MIN SPEED to give the desired minimum motor speed. If the JOG SPEED function is required, operate the JOG mode (see section 5.11 for typical jogging systems) and adjust the JOG SPEED preset clockwise to the desired level. (5% max)

MAX CURRENT

Adjust the MAX CURRENT preset to the desired level. (Clockwise rotation gives a linear increase in current limit). Full rotation corresponds to the maximum nominal rating of the drive. The TIMER lamp comes on if the current demand exceeds 105% of the preset level. While adjusting the MAX CURRENT preset, the lamp may be used to find the approximate load current by noting the preset rotation angle percentage as the lamp changes state. Eg. If the lamp changes at 50% rotation, the load is drawing approximately 50% of the rated drive current.

UP AND DOWN RAMPS

Final adjustment of the up and down ramps can now take place.

The stability of the SPEED and CURRENT loop can be adjusted. The initial setting of midway is usually optimum for the speed STAB preset. Clockwise rotation of the STAB preset increases the response of the drive. Excessive rotation may cause speed or current instability, and possibly the timer lamp to glow dimly. (This indicates that the increased STAB has amplified noise or ripple on the tacho or reference inputs causing the current demand to fluctuate into the overload region. If the noise cannot be eliminated then the STAB preset must be rotated anti-clockwise to reduce the effect as far as possible). Adjustment of the current loop (TORQUE) stability should not be attempted without the aid of an oscilloscope. (Adjustment is not normally needed, anti-clockwise optimum)

CURRENT RESPONSE

Arrange for a small square wave perturbation (20%) to be imposed on the speed demand. This may be derived from a waveform generator and input via T6 in SPEED mode with the ZS jumper parked on one pin.

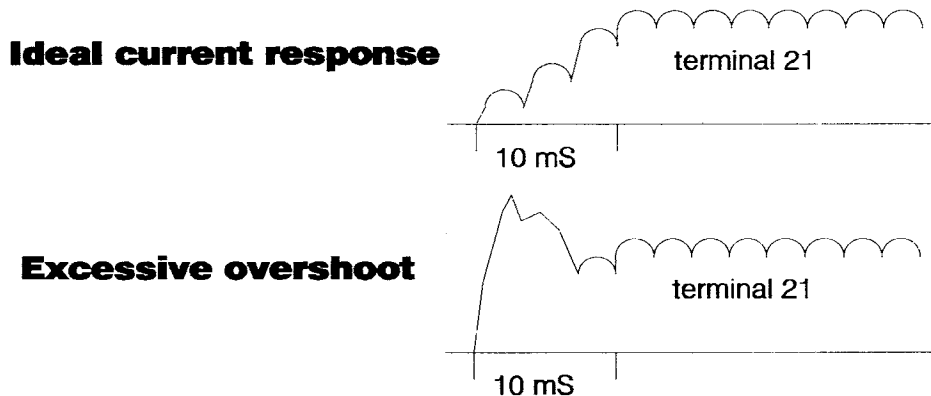

Overshoot may be reduced by anti-clockwise rotation of the speed or current stability presets. The suggested strategy for adjustment is to set up the speed response first with current stability anticlockwise (factory setting).

SPEED RESPONSE**CURRENT REDUCTION**

When customer systems are being tested prior to shipping it is sometimes only possible to use a small unloaded motor. This may lead to speed instability. A current reduction jumper has been provided to reduce the current scaling by 50%. This will improve speed stability whilst testing is in progress. See Customer presets section 1.

Clockwise rotation of STAB to increase speed of response. Do not allow excessive overshoot to occur. Note if there is excessive overshoot in tacho feedback mode, check tacho couplings are stiff and not slipping. Extra response can be gained by adding a 0.1uF capacitor in the DIFF position. (see block diagram section 1 and Field control section 3). This provides feed forward of the tacho signal and allows the STAB preset further rotation. Re-check the current response after adding the differential term to make sure there is no excessive overshoot. If the tacho signal is noisy then adding the differential term may lead to erratic current stability. Ensure the tacho signal is clean by observing it on an oscilloscope before implementing the differential term.

POWER OFF

The drive should now be set up and ready to operate. Press the POWER OFF button. The main CONTACTOR should drop out and the motor will coast to rest.

END OF PROCEDURE

These set up procedures are intended as a general guide and can not be expected to cover all possible configurations.

The drive provides protection for the system in the event of certain dangerous conditions. If an alarm is triggered the drive is instantly quenched followed by automatic de-energisation of the main CONTACTOR. The alarm condition remains latched and is indicated by a lamp on the drive. There is provision to defeat any individual alarm, and an external RESET terminal is provided. It is also possible to gain access to the individual lamp outputs for external indication if required. (see Field control and diagnostics section 3)

LAMPS

ALARM FUNCTION

 FIELD LOSS

If the field current drops below 2% of the maximum FIELD current rating of the drive unit, then this alarm will be triggered. This alarm is inhibited during a POWER off sequence. (Field weakening systems may trigger this alarm if they are unstable)

 TACHO LOSS

If there is a complete loss of tacho feedback causing the motor to overspeed this alarm will trigger. An internal circuit continually monitors the current demand and the armature voltage and operates when both parameters indicate loss of feedback. This function is automatically inhibited in ARMATURE VOLTAGE feedback mode.

 PEAK AMPS

If the current reaches 400% of the maximum drive rating this alarm will trigger. If this occurs on initial power up, suspect a wiring fault. If it occurs during running suspect a motor fault. If it occurs repeatedly a damaged thyristor may be the cause. This alarm can only be reset by removing the supply.

 AUX. TRIP
(heatsink temp)

This alarm is provided for external use and is connected via terminal 25. The terminal possesses a 1K Ohm pull up resistor to +12V. The alarm will trigger when the resistance to 0V (com). exceeds 2K Ohm. It will not trigger if the resistance to 0V remains below 200 Ohms. It is also triggered by excessive heatsink temperature.

PHASE LOSS

If any of the auxiliary phases is lost, then this condition will be detected within 20mS and the MAIN CONTACTOR will be de-energised. There is no indicator LAMP.

DEFEATING THE ALARMS

If an alarm is not required to operate it may be defeated.

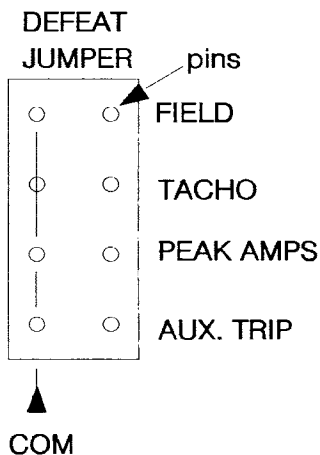

A double row of pins located on the control card provides the function. Locate the jumper across the appropriate pair of horizontal pins. The COM pins are at 0V and used to park the jumper when the defeat function is not required. The pins may also be wire wrapped. Any number of alarms may be defeated. (NOTE: if the AUX. TRIP is defeated then the heatsink temperature alarm is also defeated)

RESETTING ALARMS.

A triggered alarm may be reset via terminal 26 and is achieved by momentarily shorting to 0V (com). T26 has a 47K Ohm pull up to +24V. (Remove supply for PEAK AMPS). *Note. If the contactor control method is by a maintained contact between T28 and T29 then resetting alarms may be dangerous. If the contact is still closed after a trip event, then when a reset is activated the main power contactor will immediately energise. To overcome this problem use a de-latching circuit activated by the main contactor. This must cause the maintained contact to open when the main contactor is de-energised.*

WARNING! DO NOT DEFEAT ANY ALARM WITHOUT DUE CONSIDERATION TO SAFETY.

STALL

TIMER



The STALL alarm has the same effect as the other alarms, but due to the important nature of this alarm it is not able to be defeated or reset in the same way.

It is triggered by a timer according to the current demand. (150% for 30secs, 125% for 60secs, 110% for 120secs). The timer starts timing when the current demand exceeds 105%. This is indicated by the TIMER LAMP.

A number of conditions can lead to excess demand and hence STALL. EG Incorrect current calibration, underated motor, jammed or excessive load, incorrect feedback scaling, slipping tacho coupling, supply too low for required output, incorrect motor wiring, excessive speed demand input, in fact any reason that prevents the speed loop from achieving what it is being asked to do.

The only way to inhibit the STALL alarm is to prevent the current demand exceeding 100%. To do this the drive must be in TORQUE mode with an external current demand input via terminal 6 at or below 100% (0 to +10V = 0 to 100%). The STALL alarm may be reset by momentarily shorting T62 (SS) to T61 (+12V.)

For further information see STALL TIMER in section 3.

+

-



These lamps indicate the polarity of the current demand. One lamp will remain on while the auxiliary supply is energised by two or more lines. WARNING: Do not assume that the supply is disconnected if both lamps are off.

FIELD VOLTAGE DISPLAY

100% represents 0.9 times AC supply.

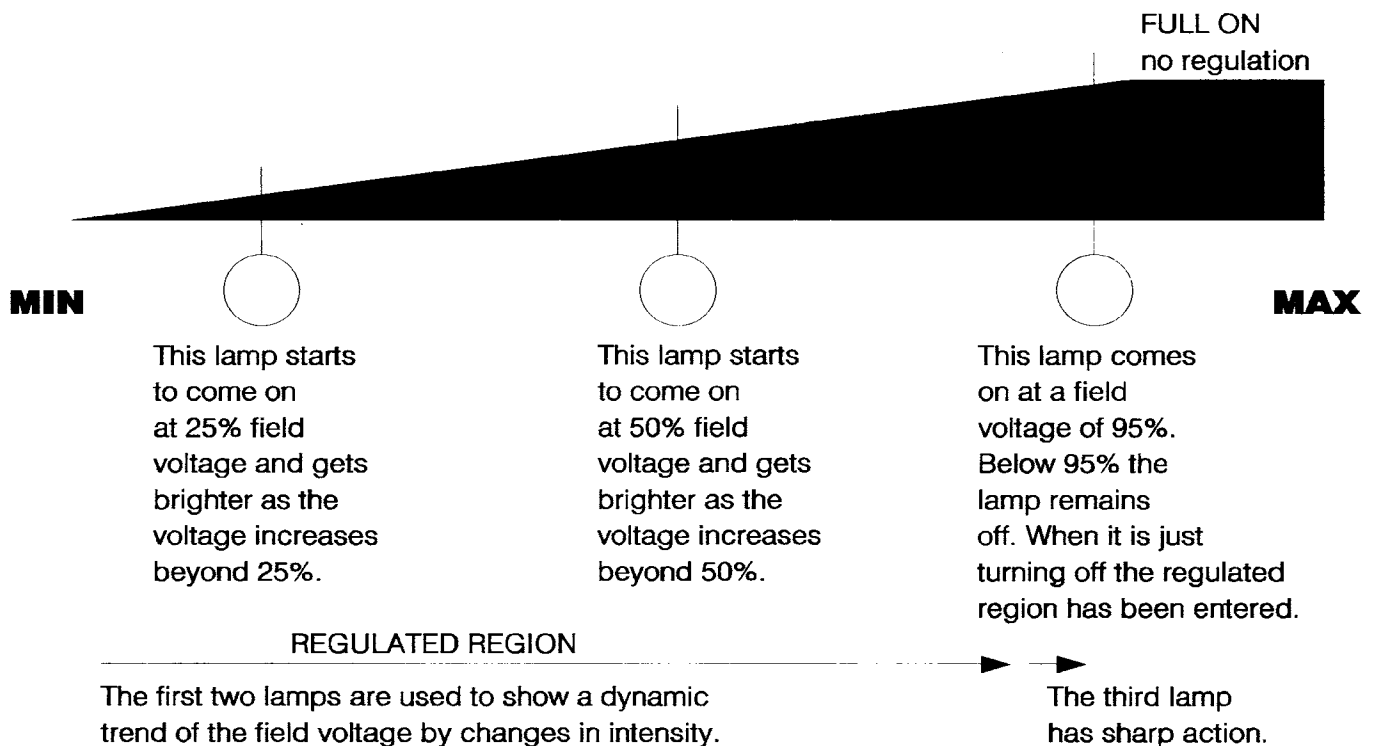

UG100996 ISS14

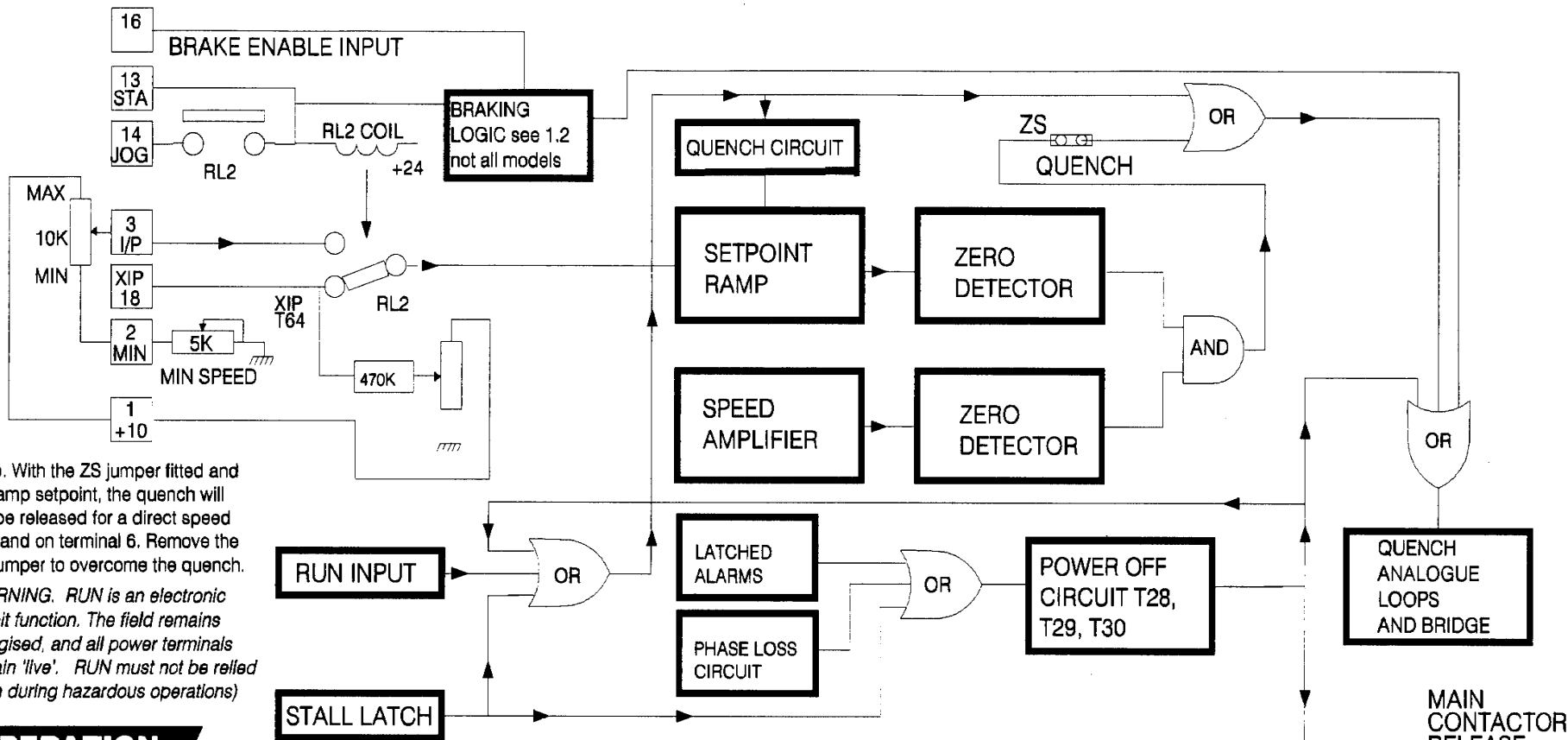

Note. With the ZS jumper fitted and no ramp setpoint, the quench will not be released for a direct speed demand on terminal 6. Remove the ZS jumper to overcome the quench.
 (WARNING. RUN is an electronic inhibit function. The field remains energised, and all power terminals remain 'live'. RUN must not be relied upon during hazardous operations)

OPERATION

List of possible sources of inhibit request.

- 1) Stall timer latch triggered. POWER OFF enabled.
- 2) External run line is opened.
- 3) Zero speed is attained.
- 4) Latched alarm FAST ACTION, POWER OFF enabled.
- 5) Power off request, POWER OFF enabled.

STOPPING MODES USING THE START/JOG CONTROLS ON T13/14 WITH BRAKE ENABLE T16 CONNECTED TO COMMON. (This function is only available on models SL5-50, SL145 and SL225) T13/14 control the internal relay RL2. This relay connects the input of the ramp circuit to T3 OR T18/64. When RL2 is energised, T3 is connected. When RL2 is de-energised T3 is disconnected and T18/64 is connected. The effect of removing the input to the ramp circuit causes it to ramp to zero at the chosen DOWN rate. The graph 3 shows the effect of operating the STOP function on T13/14 when the BRAKE ENABLE input is connected to COM (T15). In this mode the braking logic detects that RL2 has become de-energised, and causes the drive unit to regenerate the stored energy in the rotating load back to the AC supply. The drive automatically controls the speed to follow the DOWN RAMP preset. The unit will not allow motoring action in this mode. Motoring action will resume after the speed has reached zero. Do not remove the ZS jumper when using BRAKE ENABLE.

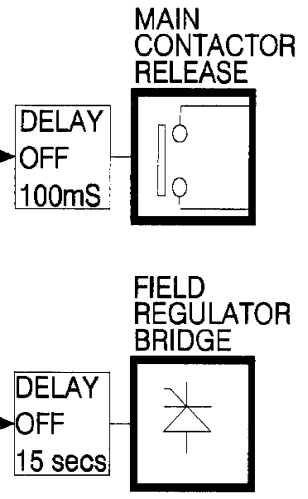
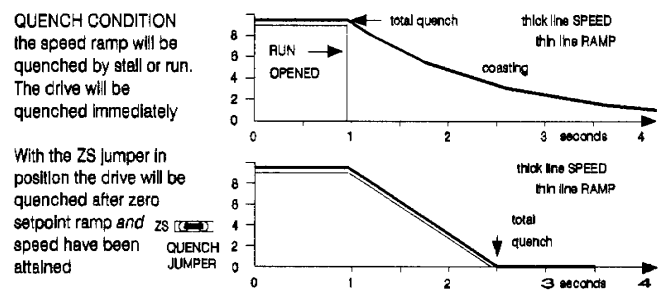
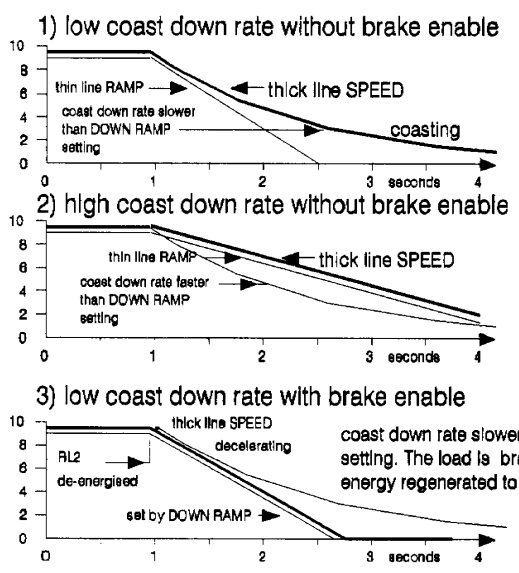

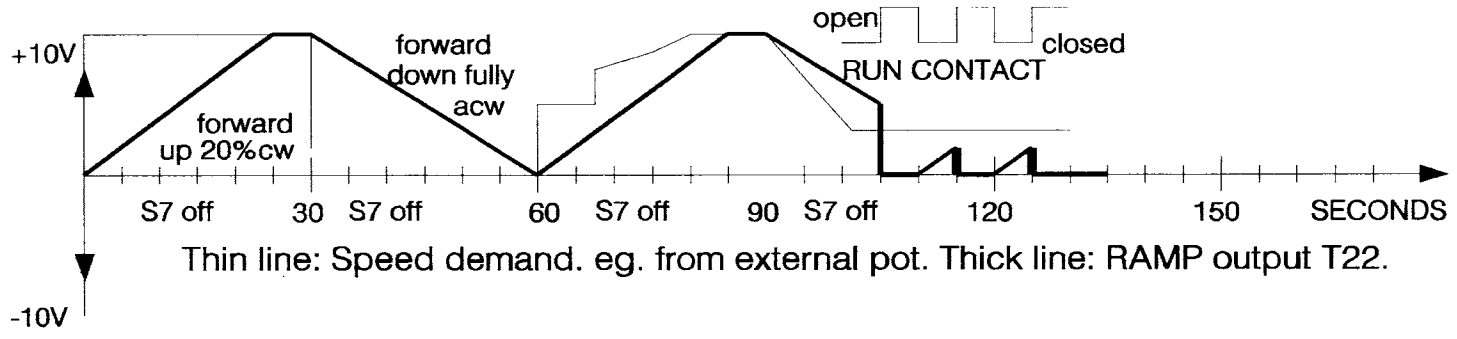
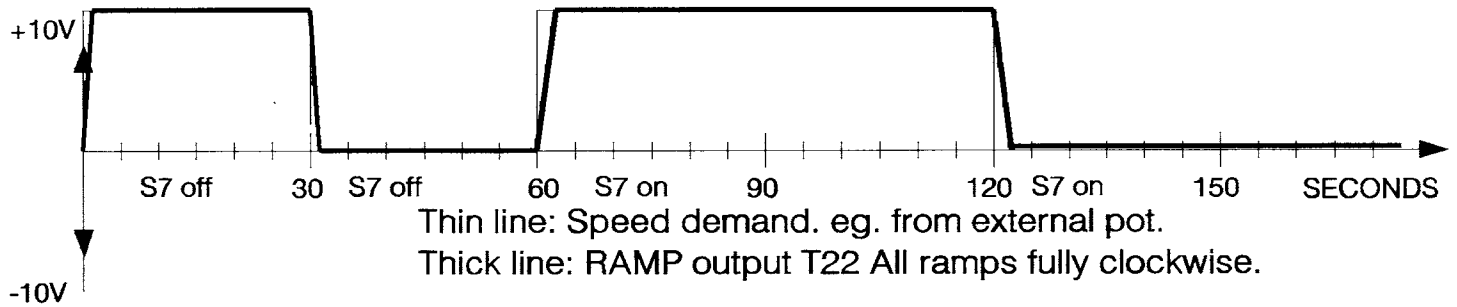
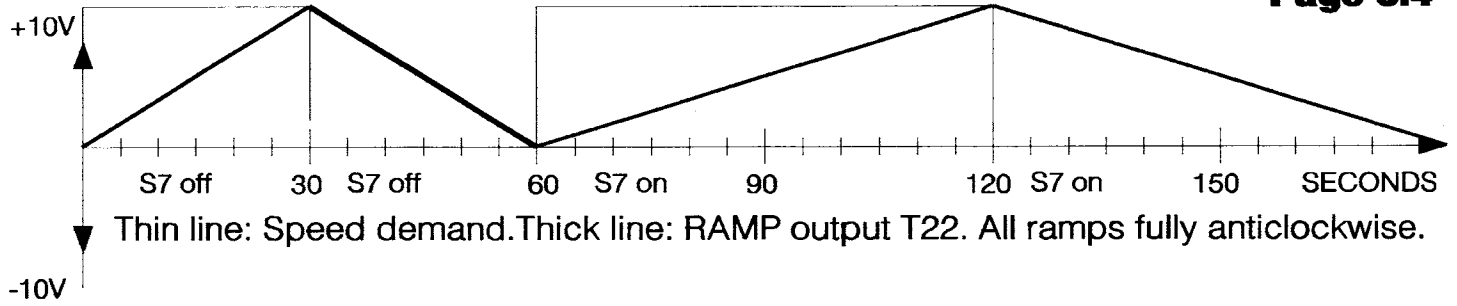

STOPPING MODES

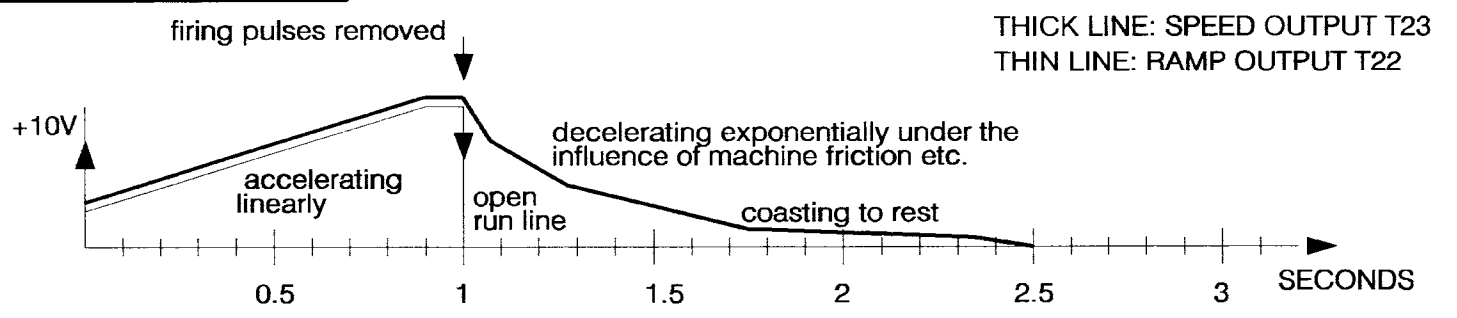

When the run line is opened, the ramp is quenched, and firing pulses removed, the motor coasts to rest.

Note, the down ramp must be set at a lower rate of deceleration than the coast down rate. On models SL5-50, SL145 and SL225 the BRAKE ENABLE function on T16 can be used for rapid regenerative deceleration. See previous page

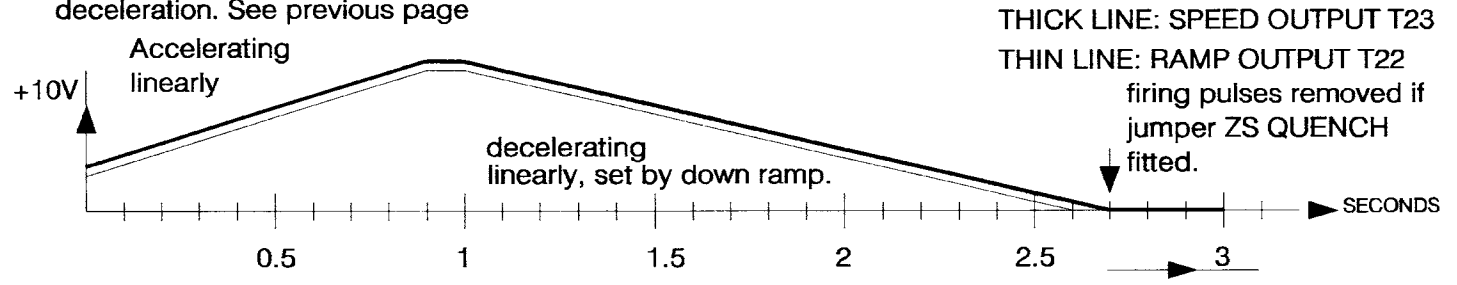

To ramp down under control of the DOWN RAMP preset, operate the STOP function on T13. This removes the speed setpoint

Firing pulses on if jumper ZS QUENCH removed.

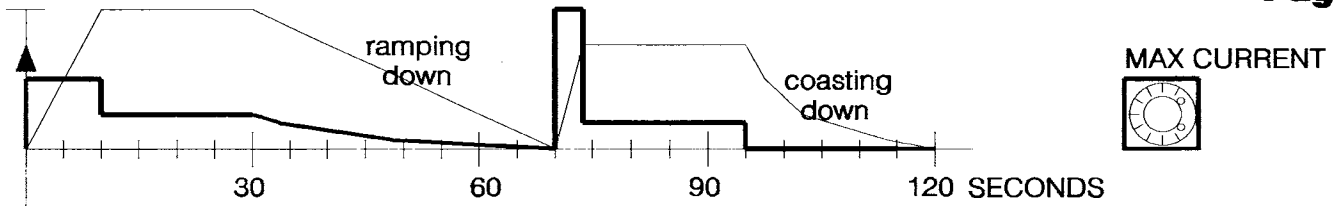

Thin line: typical speed profile, thick line: armature current required.

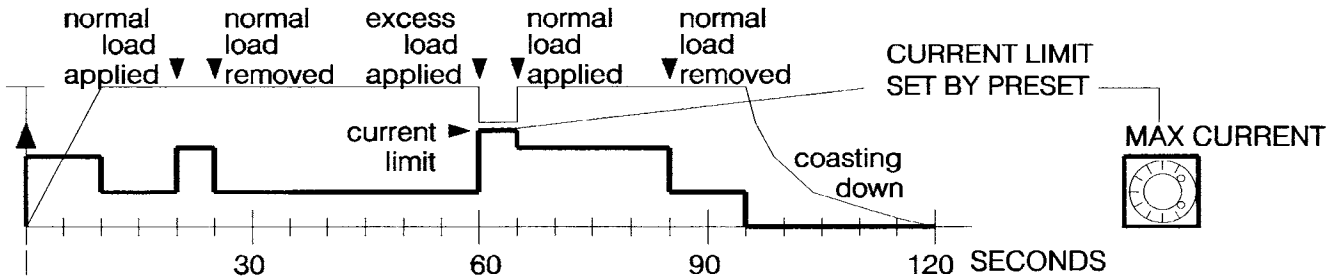

Thin line: typical speed profile, thick line: armature current required.

TORQUE FUNCTIONS

Facilities are provided for controlling the torque (current) instead of speed (volts) of the motor. This is achieved by allowing the current demand to be clamped by an external input. NOTE the current demand is provided by the speed loop and hence the speed loop must always be asking for more current than the clamp level. This technique gives automatic overspeed limiting.

TORQUE FUNCTIONS

The 2Q Torque jumper allows the current limit to be programmed by an external voltage reference. For a 0 to +10V input to terminal 6 the armature current will be 0 to 100% of the preset MAX CURRENT limit, providing the speed demand is high enough to allow it.

THIS GRAPH SHOWS HOW IN TORQUE CONTROL THE CURRENT IS CLAMPED AT THE DESIRED LEVEL ONLY AS LONG AS THE SPEED DOES NOT TRY TO EXCEED THE LEVEL SET BY THE SPEED DEMAND.

A TYPICAL EXAMPLE OF WHERE THIS MIGHT OCCUR, IS WINDING MATERIAL WITH THE WINDING REEL IN TORQUE CONTROL. IF THE MATERIAL SUDDENLY GOES SLACK, THE REEL WILL TRY TO SPEED UP. THE SPEED LOOP WILL CATCH IT.

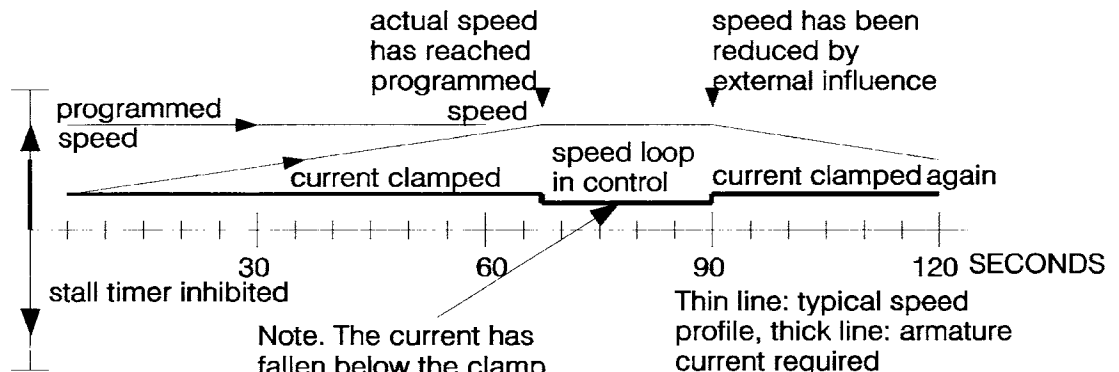

Note. The current has fallen below the clamp level here, because the speed loop now has priority.

Thin line: typical speed profile, thick line: armature current required

NOTES. The torque input signal is used to clamp the upper limit of the internal current demand signal before it is fed to the MAX. CURRENT presets. If the speed loop does not require current greater than the clamp level, then it will have control.

This is a 2 position jumper which controls the function of terminal 6 (AUX). A schematic is shown below

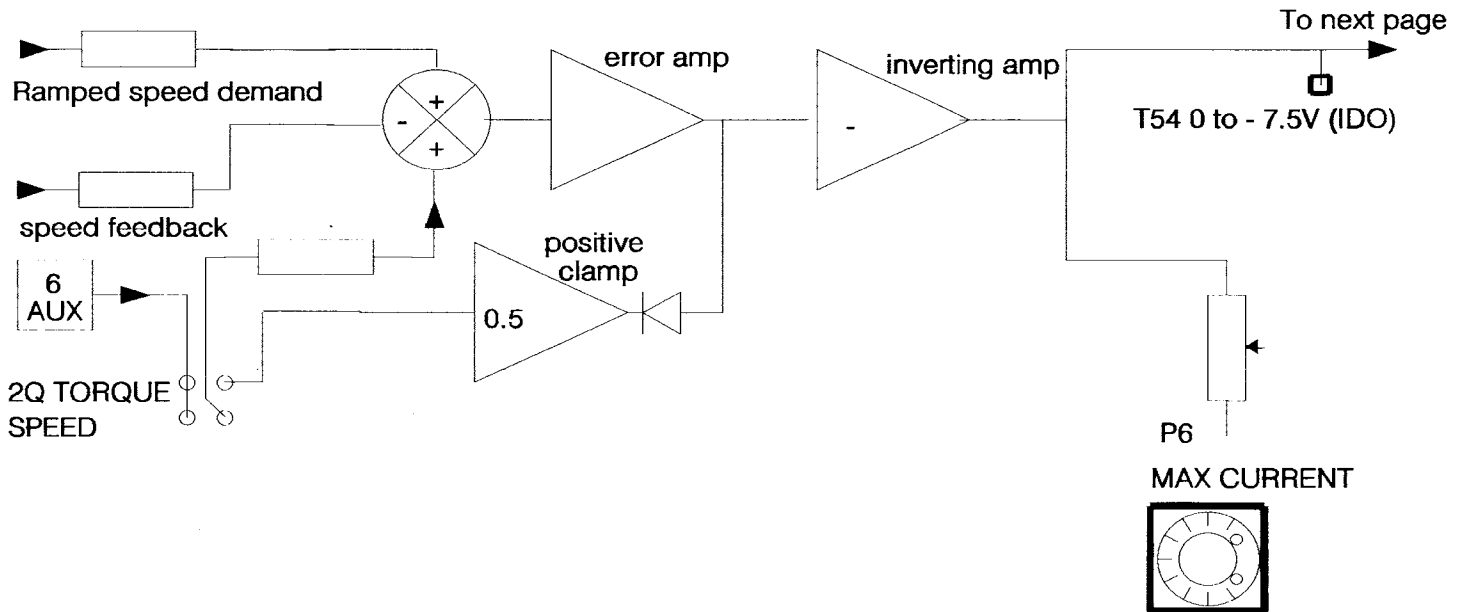

QUADRANT DIAGRAM

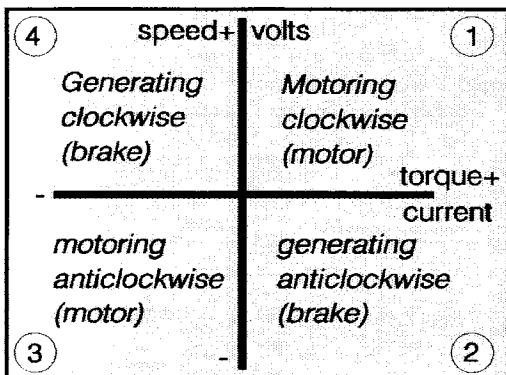

The 2Q torque clamp operates in 1 and 2 on the positive current only

3 QUADRANT UNITS

Models up to and including SL50, model SL145 and model SL225 have 3 quadrant stopping capability. (models without the feature are SL65/85/115/185/265). All 4 quadrant models in the SLX range are also capable of this mode.

The above models all allow operation in quadrant 4 when the BRAKE ENABLE function is implemented. This feature on standard single direction drives is unique to Bardac Drives. The energy which has been stored in the rotation of the motor and load, is returned to the AC supply during stopping. This can result in significant financial savings in the running costs for many applications, as well as eliminating the need for costly and wasteful external braking resistors.

The rate of braking is controlled by the DOWN RAMP preset, and the implementation of the function is described in 3.3. Section 5 includes a selection of application diagrams.

STALL TIMER

To achieve the desired speed, the outer speed loop provides the current loop with a CURRENT DEMAND signal. The timer itself is inhibited while the current demand signal lies below -5.25V (-5V represents 100%). Whenever the signal traverses into the area between -5.25V and -7.5V the stall timer starts to integrate. The rate of integration is proportional to the magnitude of the signal over 105%.

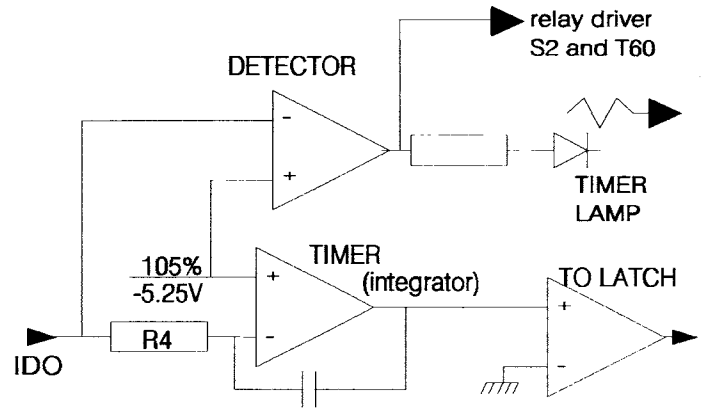
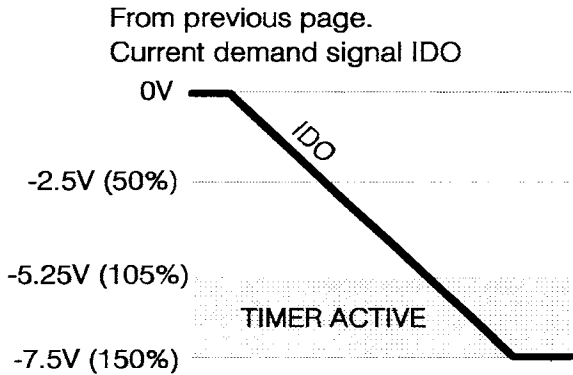

SCHEMATIC OF STALL TIMER

The time taken to integrate a 150% level is approximately 30 seconds , 125% for 60 seconds etc. Thus the stall timer allows smaller overloads for longer periods. When the current demand falls below 105% after being in overload, providing the timer has not timed out, the integrator starts to integrate back down again. This feature provides an historical store of the behaviour of the current demand. If the timer has come close to tripping, and then the demand falls below 105%, the demand will need to spend at least 30 seconds at 50% to totally reset the timer. The effect of this feature is to have the ability to provide complex overload behaviour, and trip only when the time average overload is exceeded.

50% STALL THRESHOLD

FUNCTION: TO ALLOW HIGH PEAK CURRENTS

This changes the level at which the stall timer integration starts to 52.5%. The advantage of this feature is it allows the 150% current to be achieved, but provides protection above 50%. The stall time is reduced by half. When using this feature it is important to remember that the maximum current rating of any model is unchanged, but the trip level is reduced.

RESISTOR	THRESHOLD	OVERLOAD	RATIO	PEAK %
LINK	50%	150%	1 : 3	300%
100K	60%	150%	1 : 2.5	250%
220K	70%	150%	1 : 2.1	210%
470K	80%	150%	1 : 1.87	187%
1M	90%	150%	1 : 1.66	166%
OPEN	100%	150%	1 : 1.5	150%

Other threshold levels can be implemented if a resistor is used instead of a link.

FIELD CONTROL ADJUSTMENTS

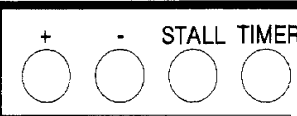

CURRENT REGULATION (linear 0-5V output signal on terminal 24 for 0-100% field current)

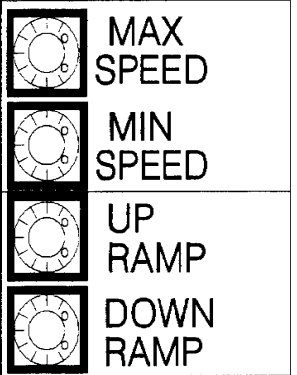

Rotate clockwise to increase field current. NOTE: When the MAX lamp on the field voltage display changes state the field voltage is at 95%. Any further clockwise rotation will be unable to increase the field current, and the constant current regulation facility will be over-riden.

If the field output is to be set up by refering to field voltage, then the CURRENT REGULATION preset may be used to set the field voltage to the required level. The current then flowing will be maintained by the control loop. Hence by eliminating field flux variations due to changes in the field current, this will provide an *enhanced level of speed control accuracy* at constant load when ARMATURE VOLTAGE FEEDBACK is being used (similar to tacho feedback).

Note. Adjusting field output by refering to field voltage
If the field voltage is close to saturation when first applying power and the field winding has not reached full operating temperature (this may take several hours), then saturation may occur during the warming up process as the field resistance increases and the loop runs out of range. Then the enhanced accuracy in AVF feedback mode will be lost. If this is important it is recommended that the system is re-calibrated when the field winding has reached maximum operating temperature.

MIN FIELD In certain field weakening applications the dynamic behaviour of the field control leads to instability if the field current undershoots. The field control and drive speed response is underdamped (indicated by the field voltage display). This can be improved by adding a 27K 0.25W 1% resistor in the MIN F location.
Note. this will result in the field voltage quench condition being 20V not 0V.

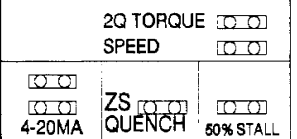
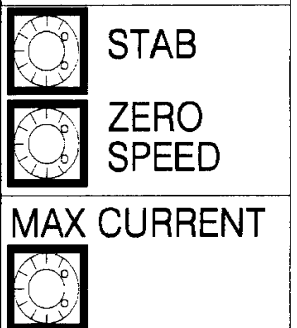

- 1) Link this pair of pads to reduce the full scale tacho volts to 25% of the standard range. This will not work with the DIFF function described below.
- 2) Add a 0.1uF capacitor as shown to implement a differential term on the tacho feedback (see STABILITY in section 2)

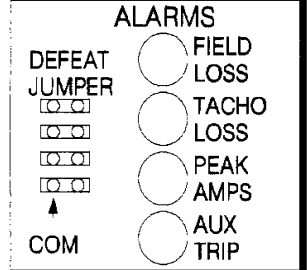
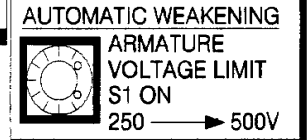
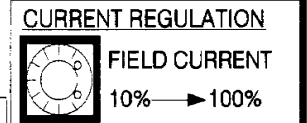
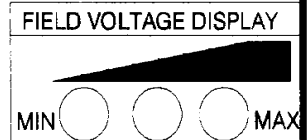
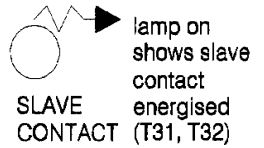
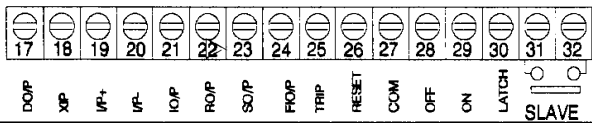
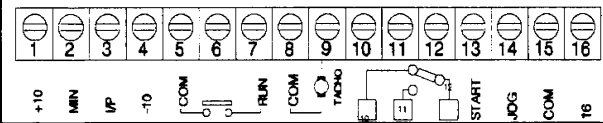
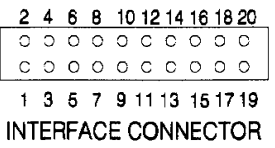

FIELD VOLTAGE DISPLAY
This indicates the approximate level of the motor field voltage. The MIN lamp starts to come on at 25% and gets brighter as the level increases. The middle lamp comes on at 50% and gets brighter as the level increases. The MAX lamp comes on at 95% at full brightness.
NOTE: the maximum available FIELD VOLTAGE is 0.9 times the AC supply. The MAX lamp is a useful indication of the field bridge just coming out of full phase angle, and into the controlled region. The other two lamps give a dynamic indication of the changing field voltage. See FIELD VOLTAGE DISPLAY section 3.

user PRESET orientation

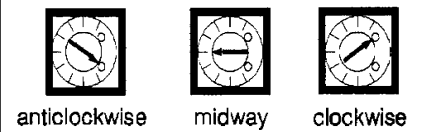

FIELD CONTROL ADJUSTMENTS

AUTOMATIC WEAKENING S1 ON

This function monitors the armature voltage and after the preset level has been reached, any further speed demand reduces the motor field current. Thus the motor speed may be increased without exceeding the rated armature voltage. This function must only be used with TACHO feedback. To set up the system, first, with the field energised and the motor at zero speed, adjust the field current to the correct maximum using the current regulation preset and by monitoring the field current signal on terminal 24.

Then calculate the level of speed demand reference which represents full armature voltage. EG. for a 3000 RPM motor and a required speed of 4000 RPM. The speed demand reference to give maximum motor rated armature voltage would be 7.5V. This reference level should be input in normal speed mode and the tacho scaling and MAX SPEED preset adjusted to give a speed of 3000 RPM.

Then starting from the fully clockwise position, rotate the AUTOMATIC WEAKENING preset anticlockwise until the field starts to reduce as shown by the display. The threshold is now set at the maximum armature voltage of the motor. (a linear signal output representing armature voltage is on terminal 56, 0 to +10V for 0 to +/-500V armature). Any further increase in speed demand should now result in a further reduction in the field volts and only a negligible change in armature voltage.

NOTE. If the armature circuit is opened, eg. by a contactor, then the field weakener will lose its measuring reference. This will cause the field current to increase, resulting in damaging armature volts. To overcome this problem, a factory fitted option is available to implement remote armature sensing when field weakening is employed with DC armature contactors.

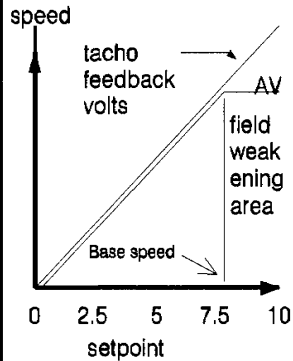

ECONOMY FIELD MODE (the field current must be set up first for accurate operation) The field is quenched 15sec. after the main power contactor is de-energised. The economy field mode allows the quench level to be set to 40% rather than 0%. This feature is used in cold or humid climates to keep the motor warm when it is not rotating. To implement the economy field mode, remove the resistor marked 'ECONOMY FIELD'

lamp on shows slave contact energised (T31, T32)
 SLAVE CONTACT

FIELD VOLTAGE DISPLAY

CURRENT REGULATION

FIELD CURRENT
 10% → 100%

AUTOMATIC WEAKENING

ARMATURE VOLTAGE LIMIT S1 ON
 250 → 500V

ALARMS

DEFEAT JUMPER	<input type="checkbox"/> FIELD LOSS
<input type="checkbox"/>	<input type="checkbox"/> TACHO LOSS
<input type="checkbox"/>	<input type="checkbox"/> PEAK AMPS
<input type="checkbox"/>	<input type="checkbox"/> AUX TRIP
COM	

DELAYED FIELD QUENCH. The unit provides automatic control of the field output. When the main power contactor is de-energised by the POWER OFF function, the field current is quenched. The quench action is delayed by 15 seconds to allow dynamic braking systems to operate. R139 (8M2) sets the delay time. (2 seconds per megohm). See PRESETS in section 1 for location of R139.

To reduce the delay time
 Eg a 1M2 resistor in parallel with R139 gives 2 seconds delay before field quench.

WARNING
The field control bridge is supplied with power from the auxiliary supply inputs. These are permanently energised during normal operation. When the POWER off function is implemented the main contactor is de-energised, removing power from the main armature bridge and initiating the field quench sequence. After the field has quenched, it is still dangerous to touch the field wiring because there is only a semiconductor barrier to the supply. REMOVE ALL POWER BEFORE WORKING ON THE INSTALLATION.

2) T3 speed I/P	4) T18 speed I/P	6) T6 aux I/P	8) T7 run I/P	10) power on	12) field I/P	14) T24 field O/P	16) T5 common	18) +12	20) -12
1) T22 ramp O/P	3) T17 total O/P	5) T23 speed O/P	7) T54 I demand	9) T21 I O/P	11) RL1	13) field loss	15) tacho loss	17) peak A	19) aux. trip

these four signals can drive an external LED to show alarm status

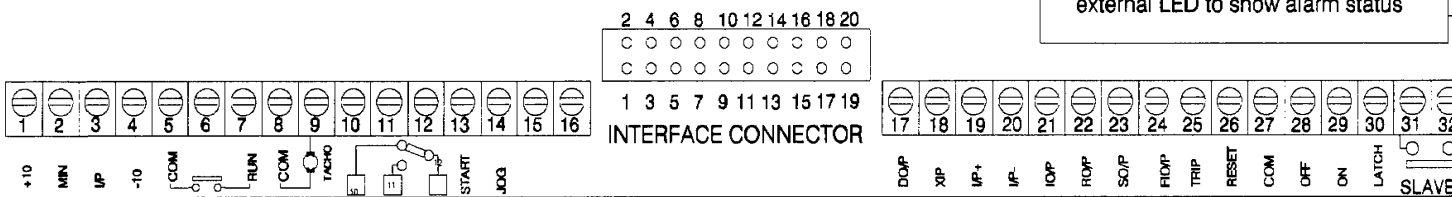

External LED lamps to show alarm status.

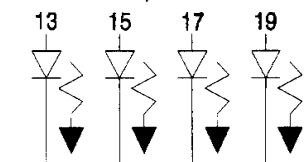

If the problem is not covered by this chart, repeat the set up procedure and try to determine at which step the problem is highlighted. Key words that are listed in the index at the back are in *italics*.

Group 1 Drive will not start during initial commissioning

Symptom	possible reason	possible remedy
1 <i>main contactor</i> will not energise	alarm tripped	find alarm cause, use defeat if able
2 no <i>alarms</i> but still no <i>main contactor</i>	<i>power on/off</i> not properly configured	check system and wiring of T28/29/30
3 <i>slave contact</i> lamp comes on but no <i>main contactor</i>	wiring or contactor coil supply problem	coil supply fuse or wrong supply volts
4 <i>main contactor</i> on, <i>run line</i> closed, and <i>speed demand</i> present	<i>Torque/speed jumper</i> in Torque position with no <i>torque demand</i> on T6	move jumper to speed position

Group 2 Drive starts but trips out on STALL

Symptom	possible reason	possible remedy
1 speed too low, <i>stall timer</i> trips	insufficient motor torque for load	check <i>max current preset</i> of drive and motor
2 same as above but <i>max current</i> correct	<i>field current</i> is too low	check field current calibration
3 speed too high and <i>stall timer</i> trips	excessive <i>speed demand</i> due to feedback cal.	check <i>feedback</i> source full scale
4 intermittent stall trip after some months	original <i>max current</i> setting marginal	re-check current calibration

Group 3 Drive starts but resulting speed not correct

Symptom	possible reason	possible remedy
1 speed changes when ancillaries energised	interference coupled onto <i>tacho feedback</i>	suppress noise or screen/filter tach
2 incorrect speed and <i>stall timer</i> lamp off	<i>speed scaling</i> not correct	check feedback source full scale
3 incorrect speed and <i>speed scaling</i> cal. is correct	speed demand is incorrect	trace all speed I/P sources to total setpoint O/P. T17

Group 4 Drive starts, runs normally, but then main contactor trips out

Symptom	possible reason	possible remedy
1 <i>field loss</i> alarm in <i>field weakening</i> mode	armature voltage changing rapidly	limit acceleration, 10 secs. for 100%
2 <i>aux. trip</i> triggered, thermistor on T25	overheated motor OR heatsink temp.	increased cooling for motor or drive.

Refer to alarms in section 3 for detailed description of all alarm functions

For further information on the cause of problems, refer to the block diagram in section 1. This is surrounded by boxes from 1 to 24, which contain keynote comments relating to each section of the drive unit. OBSERVE SAFETY

This is a list of problems most frequently encountered

- 1) Incorrect use of the main contactor POWER ON/OFF system.

External contacts that are inserted in the contactor coil supply line. If these open without the drive being inhibited in advance then the armature current will not be correctly commutated to zero causing thyristor and/or fuse damage to occur. If an external contact is mandated for safety reasons, then operating T28 100mS in advance will prevent damage.

- 2) Torque/speed jumper in the wrong position.

The drives are shipped from the factory with the jumper in the torque position for safety reasons. Quite often this gets overlooked during commissioning of speed control systems, and the drive will not run. Move the jumper to the speed position.

- 3) Control card replaced on power assembly with the connector incorrectly mated.

This sometimes happens after the control card has been removed to inspect the supply select jumpers. If the connector is difficult to see, obtain a small mirror and look from the lower right hand side of the unit.

- 4) Thyristors damaged by fault current. This is usually due to line fuses of the incorrect type being used. Refer to rating table section 3. In certain circumstances, secondary damage to the firing circuits can occur. This fact coupled with the special mounting requirements of thyristor devices, makes it advisable for a damaged unit to be returned to the manufacturer for servicing.

- 5) Thyristors damaged by fault current when correct line fuses have been used.

This is due to fault current flowing from the motor back into the drive when there is no DC semi-conductor fuse, or a DC fuse of the wrong type, fitted in series with the motor armature. This fault only normally occurs when an inertial load is regenerating into the supply, and a supply fault occurs. It rarely occurs with normal frictional type loads or with non-regenerative applications.

- 6) Timer lamp glows dimly and motor control is uneven or motor sounds erratic.

This is due to the current demand within the drive (T54) being erratic and rapidly moving in and out of the overload region, without the average level being sufficient to cause the stall timer to trip. The cause is usually a noisy tacho feedback signal which in turn causes the current demand to fluctuate wildly. Use an oscilloscope to examine the tacho signal and investigate the noise source. If it is speed related noise it may be a commutation problem with the tacho brushes, or a badly mounted tacho or poor coupling. 100Hz noise is usually mains pick up due to poor wiring practice or earth loops. (see section 3 for earth and screening recommendations)

- 7) Same problem as 6 but the tacho signal is clean.

This could be due to a noisy reference signal, particularly if the reference is derived from an upstream tacho. As in 6 the noise will need tracking down with the aid of an oscilloscope, and eliminating.

TO ILLUSTRATE SPEED SCALING CONSIDERATIONS

MOTOR DETAILS Max. armature volts 460V. Field voltage 210V
 Max. armature current 20 amps. Field current 1 amp
 Max. speed at full armature volts is 1800 RPM.

SYSTEM DETAILS The motor is driving a roller via a 3 : 1 reduction gearbox.
 a tachometer is connected to the roller shaft.

TACHOMETER 90V per 1000 RPM

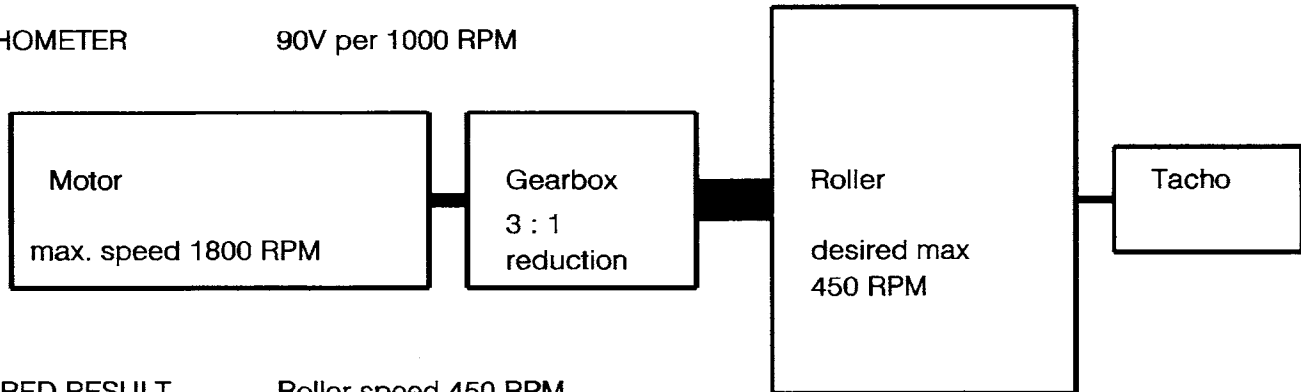

DESIRED RESULT Roller speed 450 RPM

step 1) Calculate inferred motor speed (maximum). Roller speed 450rpm therefore motor speed must be 450 times 3 = 1350rpm. (multiply output RPM by gearbox reduction ratio)

step 2) Calculate tachometer output voltage and inferred armature voltage.
 Tachometer output = 90V times 450/1000 = 40.5V
 Inferred arm. volts = 460 times 1350/1800 = 345V

step 3) Calculate max. possible drive output voltages in order to find out if the supply is suitable for the application.

Armature. ac times 1.1 which is 415 times 1.1 = 460V

Field. ac times 0.9 which is 415 times 0.9 = 370V

Armature volts required 345, maximum available 460V hence OK

Field volts required 210, maximum available 370 hence OK

Note, in this case the maximum volts available exceed the required levels by a considerable margin, hence care must be taken to approach the limits from the right direction. Follow the set up procedure to ensure this.

Set up field regulator section to give correct output, refer to section 3.

step 4) Commissioning according to preferred set up procedure.

Initially in armature voltage feedback mode with tacho wire removed (T9).

Set up to 345 armature volts for +10V speed demand. Measure tacho volts and confirm,

a) voltage is -40.5V measured with respect to common (terminal 8).

b) polarity is negative for positive demand, and correct rotation sense. Independant speed verification using hand held tachometer or known speed monitor is advisable.

Rescale S3, S4 for correct range (30-60) both off . Re-connect tacho and set feedback source to tacho. S8 off. Set MAX SPEED preset ACW. initially, then recalibrate final max speed to give tacho volts of -40.5 .

RATING TABLES

RATING TABLE UP TO SL50

(Rating depends on motor type) (35 cubic ft./min = 1 cubic m/min)

DRIVE MODEL NUMBER	MOTOR O/P			MAXIMUM CONTINUOUS AMPS		MAX FIELD AMPS	OPTION FIELD AMPS	MAIN FUSES max I ² t	AUXILIARY FUSE rating max I ² t		LINE REACTOR TYPE	UNIT AIR FLOW	
	AT 460V KW	500V HP	HP	Input	Output				AMPS	AMPS		AMPS	I ² t
* SL5	5	6.6	7.5	10 AC	12 DC	2.5	7.5	600	20A	365	LR48	17	N 45
* SL10	10	13.3	15	20 AC	24 DC	2.5	7.5	600	20A	365	LR48	17	N 80
* SL15	15	20	20	30 AC	36 DC	2.5	7.5	600	20A	365	LR48	17	N 120
* SL20	20	26.6	30	40 AC	48 DC	2.5	7.5	5000	20A	365	LR48	17	N 120
* SL30	30	40	40	60 AC	72 DC	5.0	10.0	5000	20A	365	LR120	35	F 200
* SL40	40	53.3	60	80 AC	96 DC	5.0	10.0	5000	20A	365	LR120	35	F 300
* SL50	50	66.6	75	100 AC	120DC	5.0	10.0	11850	20A	365	LR120	35	F 320

* 3Q regenerative stopping capability

RATING TABLE SL65/85/115/145

(Rating depends on motor type) (NOTE 60cfm = 2 cubic m/min)

MODEL NUMBER	MOTOR O/P			MAXIMUM CONT. AMPS		MAX FIELD AMPS	OPTION FIELD AMPS	MAIN FUSES MAX I ² t	AUXILIARY FUSE RATING			LINE REACTOR TYPE	UNIT AIR MAX FLOW WATTS	
	AT 460V KW	500V HP	HP	I/P	O/P				AMPS	max I ² t	SPRINT FUSE (European)		AIR FLOW	MAX WATTS
SL65	65	90	100	124 AC	155 DC	10 A	15 A	108000	20A	365	CH00620A	LR270	60cfm	350
SL85	85	115	125	164 AC	205 DC	10 A	15 A	108000	20A	365	CH00620A	LR270	60cfm	475
SL115	115	155	160	216 AC	270 DC	10 A	15 A	128000	20A	365	CH00620A	LR270	60cfm	650
*SL145	145	190	200	270 AC	330 DC	10 A	15 A	128000	20A	365	CH00620A	LR330	60cfm	650

* 3Q regenerative stopping capability

RATING TABLE SL185/225/265

(Rating depends on motor type) (NOTE 180cfm = 6 cubic m/min)

MODEL NUMBER	MOTOR O/P			MAXIMUM CONT. AMPS		MAX FIELD AMPS	OPTION FIELD AMPS	MAIN FUSES MAX I ² t	AUXILIARY FUSE RATING			LINE REACTOR TYPE	UNIT AIR MAX FLOW WATTS	
	AT 460V KW	500V HP	HP	I/P	O/P				AMPS	max I ² t	SPRINT FUSE (European)		AIR FLOW	MAX WATTS
SL185	185	250	270	350 AC	430 DC	10 A	30 A	240000	20A	570	CH00620A	LR430	180cfm	1000
*SL225	225	300	330	435 AC	530 DC	10 A	30 A	240000	20A	570	CH00620A	LR530	180cfm	1300
SL265	265	360	400	520 AC	630 DC	10 A	30 A	306000	20A	570	CH00620A	LR630	180cfm	1600

* 3Q regenerative stopping capability

(Aux fuse for high field option is CH00850A)

Venting

Please consider the total dissipation within the enclosure when calculating the required air throughput. This includes the fuses, line reactors and other sources of dissipation. See the appropriate pages for dissipation ratings.

HIGHER POWER MODELS

Please refer to your supplier for information about units with higher output ratings than those listed here.

IMPORTANT WARNING. DO NOT ALLOW ARMATURE CURRENT LIMIT TO EXCEED MOTOR RATING. IF THE MOTOR CURRENT RATING IS LESS THAN THE DRIVE RATING, USE MAX CURRENT PRESET TO REDUCE THE CURRENT LIMIT. ALTERNATIVELY THE DRIVE MAY BE DE-RATED BY RE-BURDENING THE CURRENT TRANSFORMERS ACCORDING TO THE FOLLOWING FORMULAE. :-

UP TO SL145 $R(KOhms) = 2/IMAX..$

FOR SL185/225/265 $R(KOhms) = 4/IMAX$

The burden resistors R100/R101/R102 are in parallel, and are found on the bottom edge of the lower power board.
UG101530 ISS15

MODEL	MAX I OF FUSE	AC I/P AMPS	DC O/P AMPS	LITTLEFUSE				BUSS (EU)		IR American Style XL25 is not UL recognised		IR BS88 UP TO 250V AC SUPPLY	IR DIN UP TO 500V AC SUPPLY	FERRAZ(not UL recognised)	
				UP TO 250V AC SUPPLY	UP TO 500V AC SUPPLY	UP TO 500V AC SUPPLY	UP TO 500V AC SUPPLY	UP TO 250V AC SUPPLY	UP TO 500V AC SUPPLY	UP TO 250V AC SUPPLY	UP TO 500V AC SUPPLY				
SL 5	600	10	12	L25S 12	L50S 12	FWH 12	FWH20A14F	XL25X15	XL50F015	L350-12	661RF0025	URE 12 P 97487	6,600 CP URD 22-58/25 B 93 956		
SL 10	600	20	24	L25S 25	L50S 25	FWH 25	170L1013	XL25X25	XL50F025	L350-25	661RF0025	URE 25 X 97494	6,600 CP URD 22-58/25 B 93 956		
SL 15	600	30	36	L25S 40	L50S 40	FWH 40	170L1013	XL25X40	XL50F040	L350-40	661RF0035	URGS 35 T 76653	6,600 CP URD 22-58/40 S 94 822		
SL 20	5000	40	48	L25S 50	L50S 50	FWH 50	170M1564	XL25X50	XL50F050	L350-50	661RF0050	URGS 50 V 76654	6,600 CP URD 22-58/50 W 94 779		
SL 30	5000	60	72	L25S 80	L50S 80	FWH 80	170M1566	XL25X80	XL50F080	L350-80	661RF0080	URGS 75 X 76656	6,600 CP URD 22-58/80 A 94 829		
SL 40	5000	80	96	L25S 100	L50S 100	FWH 100	170M1567	XL25X100	XL50F100	L350-100	661RF00100	URZ 100 Y 85558	6,600 CP URD 22-58/100 Y 94 827		
SL 50	11850	100	120	L25S 125	L50S 125	FWH 125	170M1568	XL25X125	XL50F125	L350-125	661RF00125	URZ 125 G 97526	6,600 URGD 27-60/125		
SL 65	108000	124	155	L25S 175	L50S 175	FWH 175	170M1569	XL25X175	XL50F175	L350-180	661RF00160	URZ 160 H 97527	6,600 URGD 27-60/160		
SL 85	108000	164	205	L25S 225	L50S 225	FWH 250	170M3816	XL25X250	XL50F250	T350-250	661RF00250	URY 260 N 97670	6,600 URGD 27-60/250		
SL 115	128000	216	270	L25S 275	L50S 275	FWH 300	170M3816	XL25X300	XL50F300	T350-315	661RF00315	URY 300 P 97625	6,600 URGL 36-55/280		
SL 145	128000	270	330	L25S 350	L50S 350	FWH 350	170M3818	XL25X350	XL50F350	T350-355	661RF00350	URY 325 Q 97626	6,600 URGM 2X36-55/325		
SL 185	240000	350	430	L25S 450	L50S 450	FWH 450	170M5809	XL25X450	XL50F450	TT350-500	661RF00450	URAB 450 B 97682	6,600 URU 2X36-55/500		
SL 225	240000	435	530	NO FUSE AVAILABLE	L50S 550	FWH 600	170M5811	NO FUSE AVAILABLE	XL50F600	TT350-630	661RF2 630	URAB 550 E 97685	NO FUSE AVAILABLE		
SL 265	306000	520	630	NO FUSE AVAILABLE	NO FUSE AVAILABLE	FWH 700	170M6811	NO FUSE AVAILABLE	XL50F700	TT350-710	661RF2 700	UGH 700 E 82459	NO FUSE AVAILABLE		

FUSE SELECTION

IN GENERAL THE AC SUPPLY CURRENT PER PHASE IS 0.8 TIMES THE DC OUTPUT CURRENT, AND THE FUSE RATING SHOULD BE APPROX. 1.25 TIMES THE INPUT CURRENT. THE FUSES SPECIFIED IN THIS TABLE HAVE BEEN RATED TO INCLUDE THE 150% OVERLOAD CAPABILITY AND OPERATE UP TO 50C AMBIENT AT THE MAXIMUM DRIVE RATING. TO SELECT A FUSE AT OTHER RATINGS FOR EXAMPLE WHEN USING A MOTOR RATED AT A LOWER POWER THAN THE DRIVE UNIT OR OPERATING AT A REDUCED MAXIMUM CURRENT LIMIT SETTING. SELECT A FUSE WITH A CURRENT RATING CLOSEST TO THE ARMATURE CURRENT AND WITH AN I²t RATING LESS THAN THE MAXIMUM SHOWN IN THE TABLE. IF A DC FUSE IS FITTED IN SERIES WITH THE ARMATURE IT MUST BE A DC RATED SEMICONDUCTOR TYPE WITH CURRENT RATING 1.2 TIMES THE MOTOR FULL LOAD CURRENT, DC VOLTAGE RATING SUITABLE FOR THE MAXIMUM ARMATURE VOLTAGE AND WITH AN I²t RATING LESS THAN THE MAXIMUM SHOWN IN THE TABLE.

FUSE DERATING

The rated current for semiconductor fuses is normally given by the fuse manufacturers for copper conductors that have a current density in the order of 1.3 - 1.6 A/mm² (IEC 269-4). This low utilisation results in extra copper costs during the installation of high current systems, but helps to prevent overheating of the fuses. Alternatively it is possible to use a fuse of a higher rating, and derate it for use in standard fuseholders and installations. This derating factor is only applied to large fuses for the models SL185/225/265. Hence the fuses in the table for these models have been selected with a further derating to approx. 80% in order that they may be used in a standard fuseholder. No derating is required for installations that do comply with IEC 269-4, and in this case a smaller fuse could be selected in accordance with the recommendations given above.

European stock fuses and fuseholders

To optimise stock availability some fuses have higher than necessary current ratings but will still provide protection because the correct I²t rating is the prime factor.

Drive	Current	AC volts	fuse type	approx. dissipation for 3 main fuses at 100%	Main fuses and holders with covers	Auxiliary fuses and holders with covers
SL5 SLX5	12A	480	SIBA 7012540/12.5	5 W	FUSE HOLDER 1 POLE 6 X 32 mm (optional DIN rail clip part no. FE101969)	CH00612A CP102071 CH00620A (These are built into the drive)
SL10/SLX10 SL15/SLX15	24A 36A	480	BUSS' 170L1013	10 W 15 W	FUSE HOLDER 1 POLE 14 X 51 mm	CH00740A CP102053 CH00620A (These are built into the drive)
SL20 SLX20	48A	480	BUSS' 170M1564	40 W	FUSE HOLDER 1 POLE 00	CH00850A CP102054 CH00620A (These are built into the drive)
SL30 SLX30	72A	480	BUSS' 170M1566	45 W	FUSE HOLDER 1 POLE 00	CH00880A CP102054 CH00620A (These are built into the drive)
SL40 SLX40	96A	480	BUSS' 170M1567	60 W	FUSE HOLDER 1 POLE 00	CH008100 CP102054 CH00620A (These are built into the drive)
SL50 SLX50	120A	480	BUSS' 170M1568	65 W	FUSE HOLDER 1 POLE 00	CH008125 CP102054 CH00620A (These are built into the drive)
SL65 SLX65	155A	480	BUSS' 170M1569	75 W	FUSE HOLDER 1 POLE 00	CH008160 CP102054 FUSE HOLDER CH00620A 3 required CP102071 3 required
SL/SLX85, SL115/SLX115	205A 270A	480	BUSS' 170M3816	80 W 105 W	FUSE HOLDER 3 POLE 1	CH009250 CP102055 FUSE HOLDER CH00620A 3 required CP102071 3 required
SL145/SLX145	330A	480	BUSS' 170M6809	150 W	FUSE HOLDER 3 POLE 3	CH010550 CP102233 FUSE HOLDER CH00620A 3 required CP102071 3 required
SL185/SLX185 SL225/SLX225	430A 530A	480	BUSS' 170M6809	200 W 250 W	FUSE HOLDER 3 POLE 3	CH010550 CP102233 FUSE HOLDER CH00620A or CH00850A (30A field) 3 required CP102071 or CP102054 (30A field) 3 required
SL265	630A	480	BUSS' 170M6811	240 W	FUSE HOLDER 3 POLE 3	CH010700 CP102233 FUSE HOLDER CH00620A or CH00850A (30A field) 3 required CP102071 or CP102054 (30A field) 3 required

MECHANICAL DIMENSIONS

Four corner mounting slots are provided to mount the unit. Use M6 (1/4in) screws on models up to SL50, and M8 (5/16in) on models SL65/85/115/145. A substantial earth connection should be made to the stud provided. Nominal cooling air throughput is specified in the rating table.

NOTE: Do not block the heatsink fins. Allow at least 50mm (2 in) space.. Ensure connections to power terminals are tight.

The units must be orientated vertically as shown, on the back panel.

Venting

Please consider the total dissipation within the enclosure when calculating the required air throughput. This includes the fuses, line reactors and other sources of dissipation. See the appropriate pages for dissipation ratings.

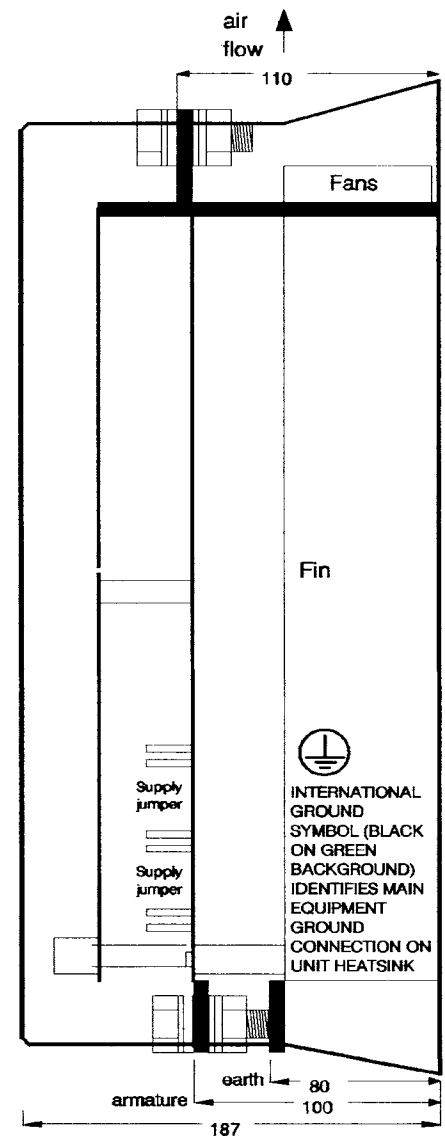
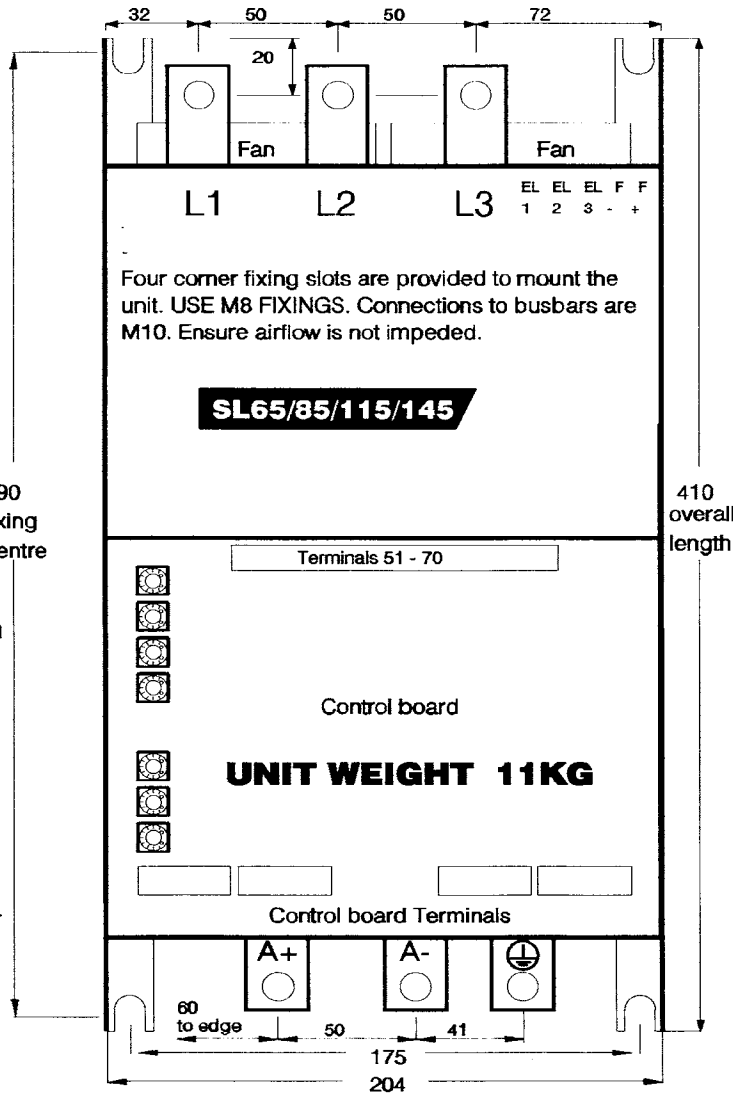
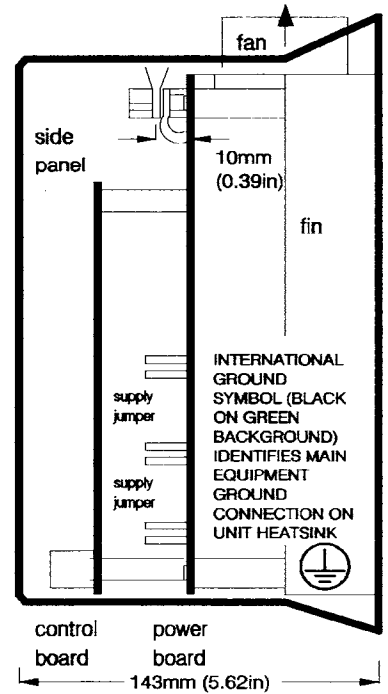
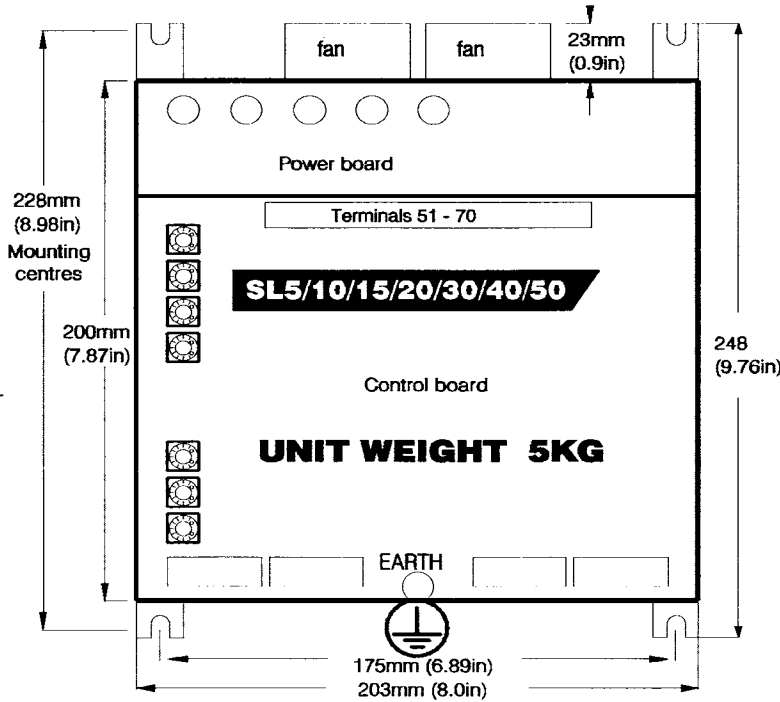

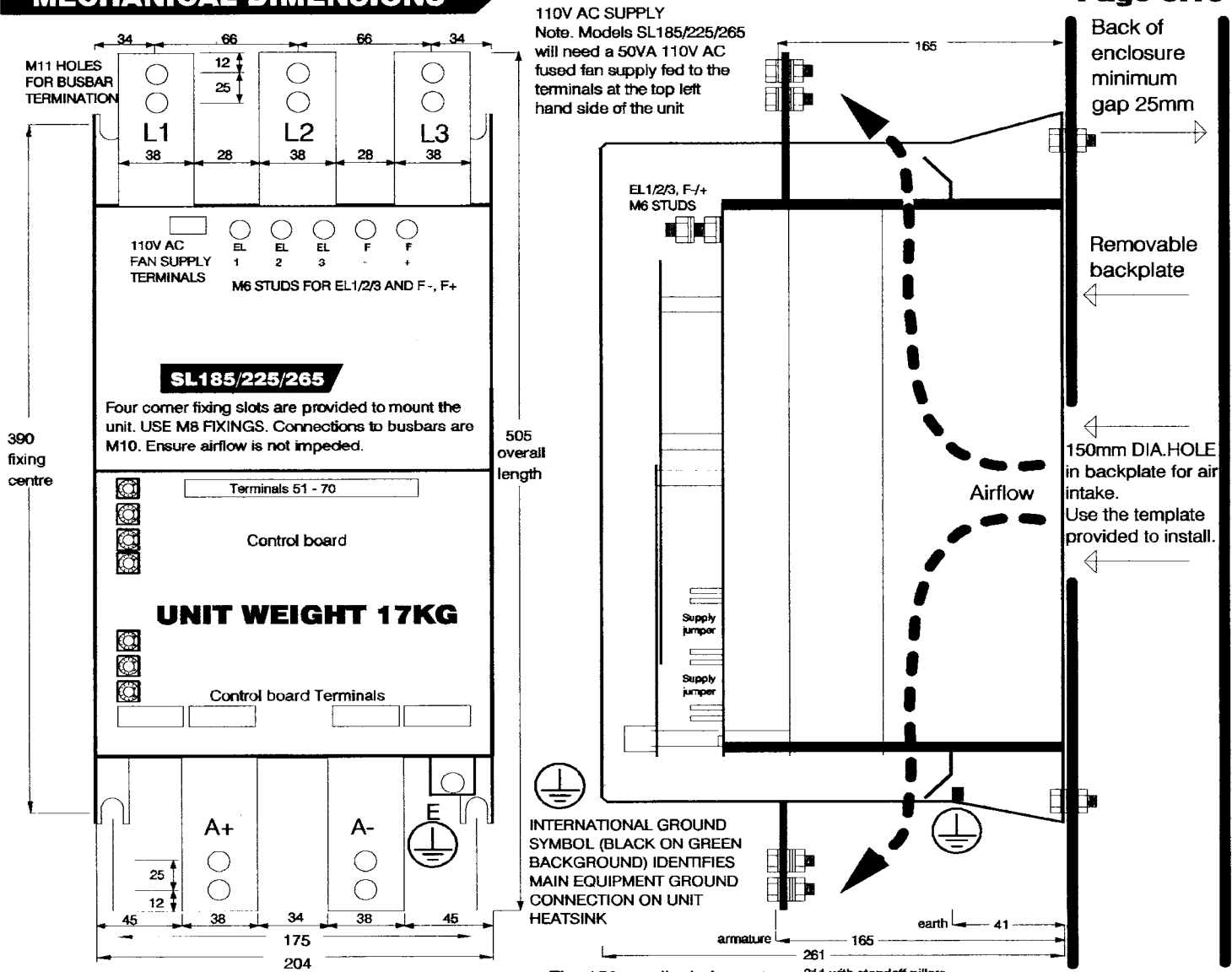

MOUNTING AND VENTILATION

The preferred method of mounting and ventilation is shown in fig. 1. This allows the optimum amount of cool air to flow over the heatsink of the drive. This method is necessary for installations requiring a 50C ambient operating temperature. However for retro fitted units etc. it may be impractical to cut a 150mm hole in the backplate. In this case the unit should be mounted on the 50mm pillars provided as in fig 2. Using this method the maximum operating ambient is 35C. An alternative solution to obtain the 50C rating without cutting a hole in the back plate, is to employ a duct to deliver external filtered dry air to the rear air intake of the drive

Venting

Please consider the total dissipation within the enclosure when calculating the required air throughput. This includes the fuses, line reactors and other sources of dissipation. See the appropriate pages for dissipation ratings.

Fig 1

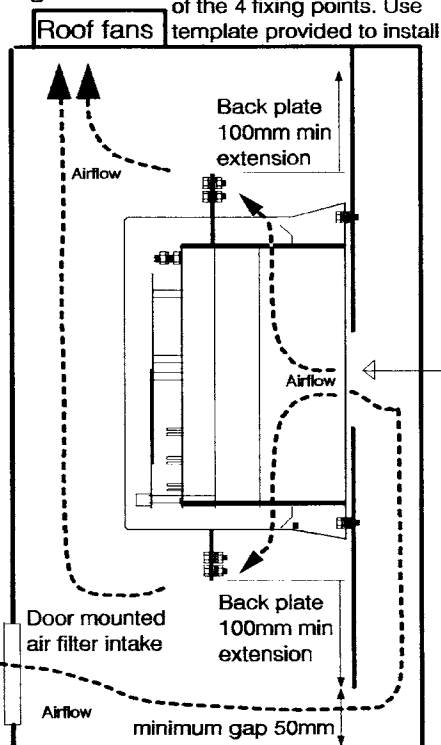

The 150mm dia. hole centre is 5mm below dead centre of the 4 fixing points. Use template provided to install

Fig 2

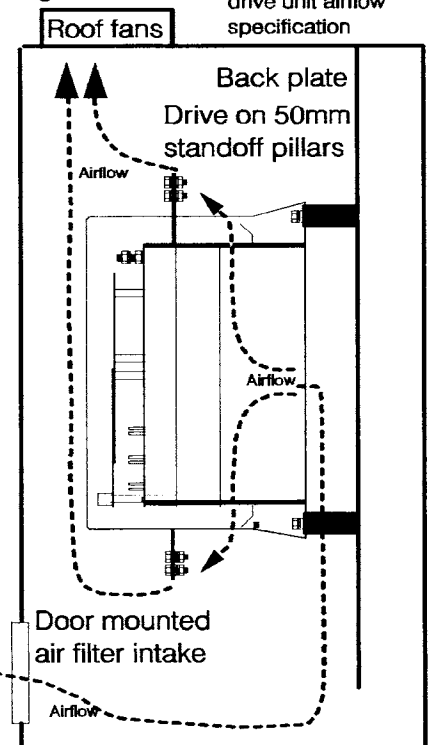

See rating table for drive unit airflow specification

Note. Only use CSA certified line reactors for installations complying with CSA codes. These units are not CSA certified. Refer to supplier for full ratings of CSA certified alternatives. The LR current ratings are specified in terms of the DC output current not the AC input current. (AC = 0.8 x DC)

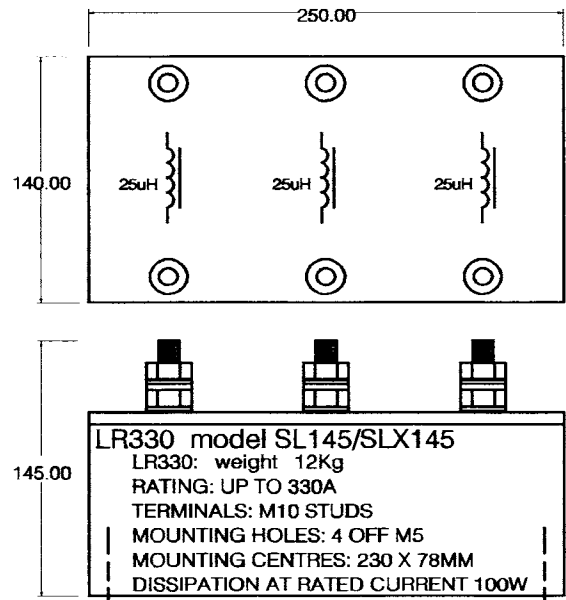
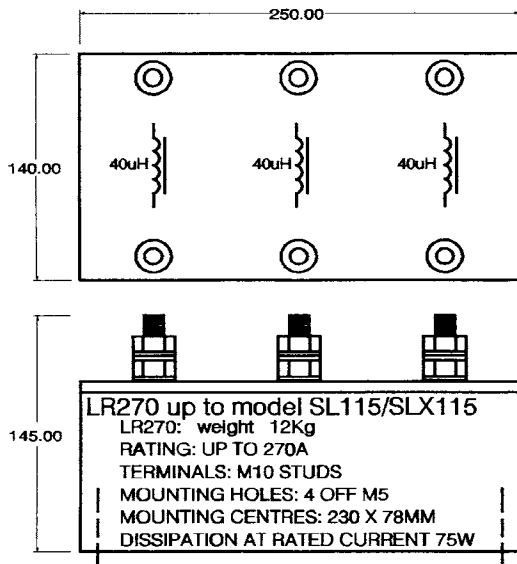
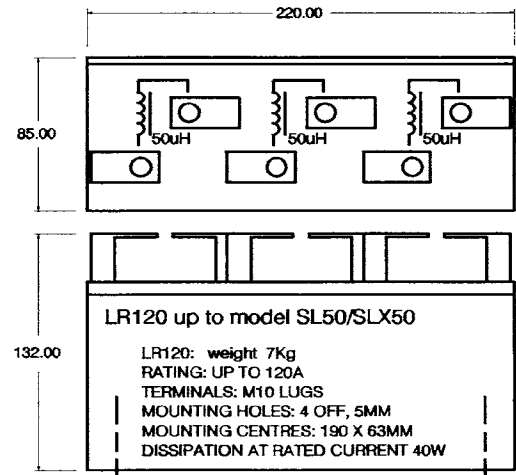
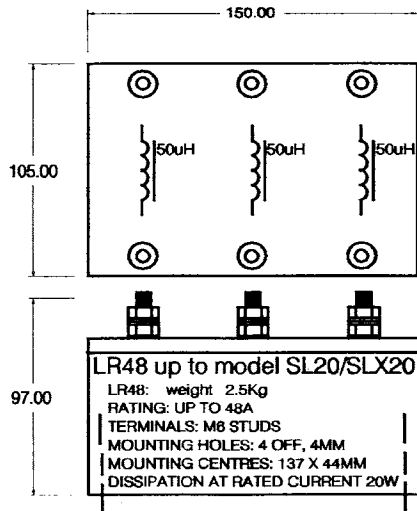

LR430 rating up to 430A for model SL185/SLX185
 LR530 rating up to 530A for model SL225/SLX225
 LR630 rating up to 630A for model SL265

These line reactors may be wall or floor mounted. The coils must be vertical as shown to ensure adequate cooling.

	LR430	LR530	LR630
A	280	360	360
B	200	250	250
C	12	12	12
D	150	150	150
E	210	200	200
F	260	310	310
G	215	265	265
H	10	10	10
L/phase	35uH	15uH	15uH
watts	250	175	200
weight	35 Kg	35 Kg	35 Kg

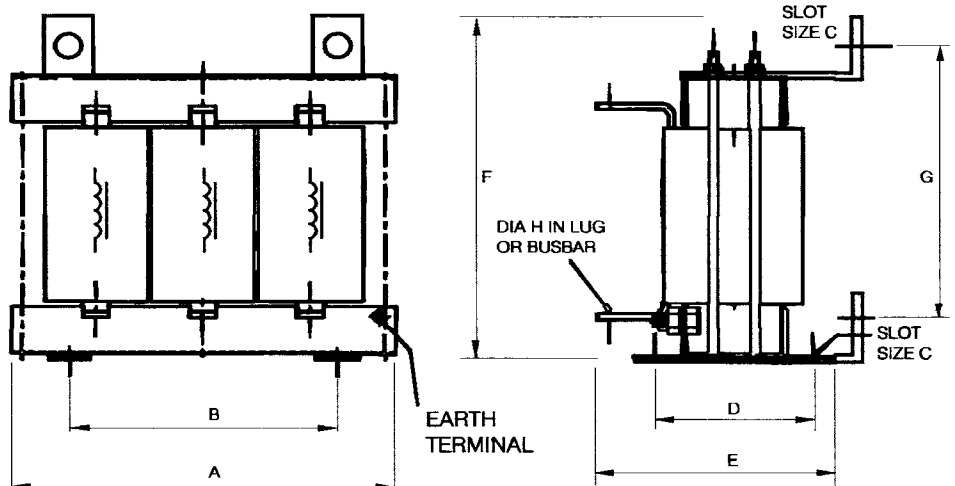

Apart from relays, the unit is completely static and requires little routine maintenance. Periodic cleaning should be done with a vacuum cleaner and small soft paint brush. Check all connections for tightness and discoloration which might indicate localised heat.

It is recommended that units requiring service be returned to the supplier. The units must be adequately protected against transit damage using double reinforced packing. However in the event that the unit must be dis-assembled, only qualified personnel familiar with power engineering should be employed.

To dis-assemble models up to SL/SLX50, follow the sequence outlined below. The higher power models have more complex high current stack assemblies and it is recommended that damaged units are returned to the supplier for inspection and servicing.

Plan view of unit with cover removed. To remove the cover, unclip top catches and apply slight outward force to side panels at hinge

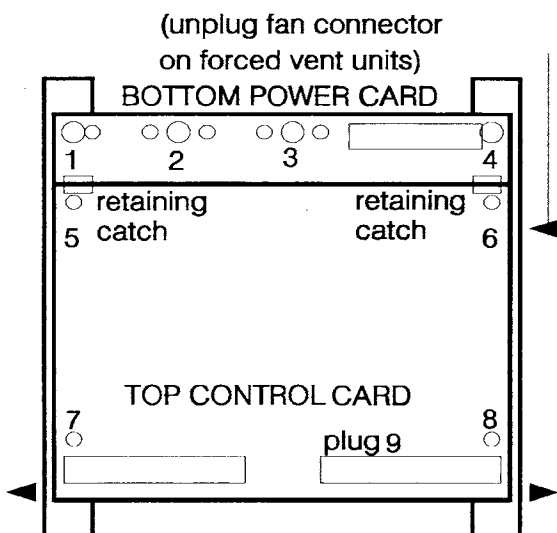

1) To remove top control card, remove plastic screws 7/8, and release the retaining catches 5/6. Carefully lift off the top card vertically from the bottom card. Avoid stressing the 20 way interconnection plug 9.

STEPS 2 AND 3 REFER TO MODELS UP TO SL50

- To remove the power card, remove plastic screws 1/2/3/4 and threaded pillars 7/8. Disconnect 12 faston plugs from thyristors. These may be fairly tight, avoid damaging the red and yellow wires. Remove 4 long busbars by removing thyristor screws. Remove remaining exposed thyristor screws.
- Lift off power card, and recover 6 supporting pillars. Unscrew temp sensor for total removal. Assemble in reverse order taking care to observe correct torque (3.1 Nm, 0.31kpm, 2.3 lbft +/-20%) when tightening thyristors. Make sure interconnection plugs are properly mated.

MAIN FUSES

The main external supply fuses must be semi-conductor fuses of the correct rating. Use of any other type may not afford adequate protection and may result in damage to the unit. Product warranty will be invalidated unless the correct type and rating of fuse is used. See rating table for MAIN FUSES.

CHECKING FOR DAMAGED THYRISTORS

Using an Ohmmeter in the 20 MOhm range, check for open circuit condition between A+ and L1/L2/L3 and A- and L1/L2/L3. (6 readings in all) If any reading is less than 20 MOhm then suspect a damaged thyristor. When taking readings allow a few seconds for the snubber circuit to charge up to the meter excitation voltage..

Change the range on the meter to 200 Ohms and measure the gate to cathode resistance of each thyristor. (Between the red and yellow leads on the gate connections). Any reading outside the range 5 to 35 Ohms indicates a damaged thyristor.

When thyristors are damaged it is sometimes possible that the associated gate firing components may also be damaged. This is why it is recommended that units be returned to the supplier for professional attention. A unit that has been returned for service will automatically be fully tested to specification on all parameters, and the expert knowledge base available will usually be able to reveal the cause of failure and suggest action for future prevention of the problem.

SPARES

- 2 Thyristors MCC 72-16io1 (up to SL50)
- 5 Aux. Fuses | semi-conductor type
- 3 Main fuses | (see rating table)
- 1 Fan assembly (forced vent units)

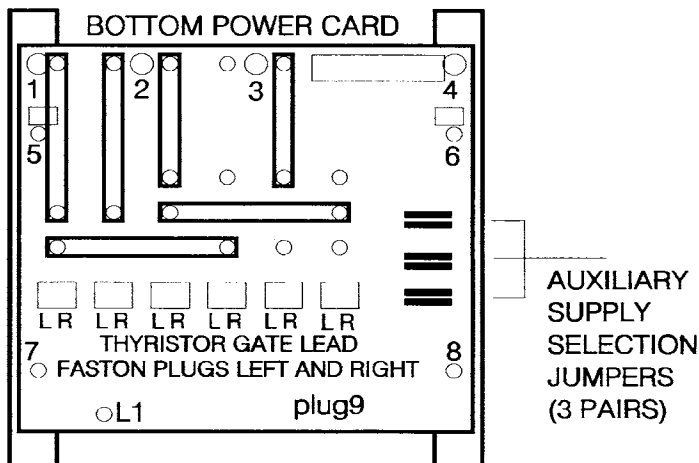

L1 lamp off if the heatsink is too hot

Larger DC motors normally 11KW and above require the use of 3 phase DC converters. Whilst there are many control comparisons with the 1 phase drives, the 3 phase converter has additional features which are useable in more sophisticated drive applications.

1. Field Weakening.

An additional feature on the Bardac SL/SLX range of drives is auto field weakening. This built in device proportionately reduces the field flux, whilst maintaining the armature flux constant to give an increased speed output. Most DC motors have some inherent field weakening range which can be used to good effect on certain applications, as shown later. The output characteristic of the drive/ motor combination is as shown, and gives a flat top constant KW characteristic to the motor. Field ranges in excess of 3:1 can be achieved at the smaller KW sizes (say up to 30KW) but reduces as the DC motor gets larger.

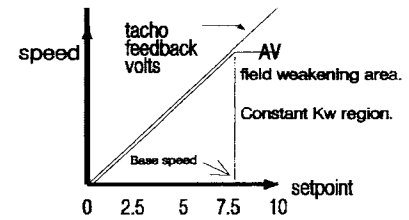

2. Load Sharing

Where an application demands close control between a number of drives, but any one drive must not be allowed to overhaul the rest, Bardac drives are configurable for load sharing. Each drive is given an equal torque demand, so any change in load demand is shared equally between drives. The simplest form of this is a nip, containing product, where each roll is driven. If both drives were independent, it is likely one of the drives would start to drive the other, to a point where one drive was idling and the other was taking twice the load. There can be several configurations of mechanical systems that involve load sharing, but they invariably have a product web of some type (metal, paper, textile) joining them together in the process line. The drive configuration is described in the Bardac application manual.

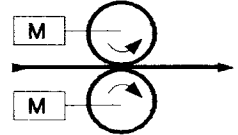

3. Master/Slave Applications.

Where a process involves multiple drive sections that require speed following, all Bardac 3 phase drives are configurable for master/slave operation. A number of follower drives can be controlled from single master drive so that an increase or decrease in the master speed produces a proportionate increase or decrease in the speeds of the following drives. Most multi drive process lines have some form of master/slave operation to allow the operator a single pot control for the machine (see Figure 3)

Caution!

If the process line has follower drives that require increases in speed relative to the master, say metal forming or wire drawing, the relative increase must be accounted for in the mechanical system, as the master drive will only give out a maximum speed signal to the followers i.e. if the last drive on the system is 20% faster than the master, an increased output speed on the motor must be selected to accommodate this. The drive configuration is described in the Bardac application manual.

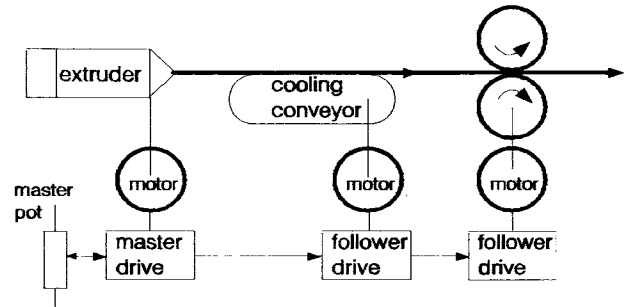

4. Winder Applications.

For coiling applications using any materials, there are a number of fundamental principles which apply.

- a) The power (KW) requirement is the same at any diameter to maintain a constant tension in the product.
- b) When selecting a suitable motor for winding applications, the maximum torque output is at maximum reel diameter, the maximum speed is at minimum diameter.
- c) The operating speed range of the drive motor combination is not just the reel build up, but is additional to the line speed. Constant tension in the reel is normally desired to prevent the core from overtightening and/or crushing.

To determine the motor power, we need the maximum torque applied, and the maximum speed of the motor shaft.

The maximum torque is at the O/D of the reel., ie:

$$\begin{aligned} \text{Torque} &= \text{Tension (n)} \times \text{Radius (m)} \\ &= 200n \times 0.32m &= 64nm. \end{aligned}$$

The maximum speed is at the I/D of the reel.

$$\begin{aligned} \text{And } N_{\text{max}} &= \frac{\text{Max line speed (m/min)}}{\text{Core circumference (m)}} \\ &= \frac{100M/\text{min}}{2 \times \pi \times 0.32} &= 500\text{RPM} \end{aligned}$$

$$\begin{aligned} \text{Required motor KW} &= \frac{T(\text{nm}) \times n(\text{rpm})}{9549} \\ &= \frac{64nm \times 500\text{RPM}}{9549} &= 3.35\text{KW}. \end{aligned}$$

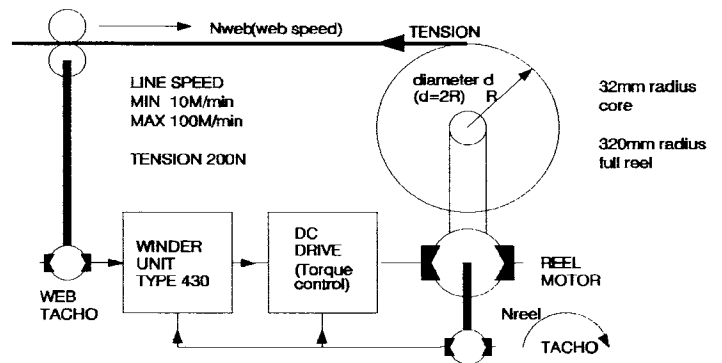

This would be the selected motor KW to give max torque and maximum speed for the conditions above. Acceleration torque must be added to the above to provide a complete picture. With the reel at maximum diameter, additional motor power is required to accelerate the reel and maintain tension during acceleration.

It should also be noted that if the line was running at minimum speed, and the reel was near maximum, the actual motor shaft speed would be:

$$N \text{ RPM} = \frac{10\text{m/min}}{2 \times \pi \times 0.32} = 5 \text{ RPM (at maximum torque)}$$

The motor/drive combination should therefore be capable of a speed range of 5-500RPM ie. 100:1, and for this reason most coilers require a very wide speed range. This speed range (100:1) is normal with Bardac 3 phase drive and motors fitted with tachogenerators, but please check the motor is capable of the speed range. Bardac have available a winder card which takes a line speed ref and compares it with the drive motor speed to give automatic control of motor torque (and thus of tension) as the reel builds up. Other features available on the winder card are:

- Inertia Compensation** A large heavy reel may require additional torque during acceleration to prevent the reel "lagging" behind the line - a pre-settable compensation function is provided to help prevent this.
- Static Compensation:** Frictional losses in the mechanical system will subtract from the torque applied by the motor. An offset is provided for this.
- Dynamic Compensation:** Other effects such as "windage" ie. rotating losses can be compensated for.
- Taper Current Control:** Certain applications require the tension to be "backed off" as the reel diameter increases, useful when winding say paper onto soft cardboard cores to prevent core crushing. The taper setting is variable and set as required. See the Bardac winder card manual.

5. Regenerative Drives.

The Bardac SLX range of drives offer a fully regenerative package suitable for controlled electronic braking and reversing. Whilst much is often made about AC drives and energy saving, the 4 quadrant DC drive is the most energy efficient drive. AC inverters usually have some form of braking resistor, effectively burning away the energy on the stopping cycle. Regenerative DC drives return their braking energy to the mains supply, where it can be drawn on by connected plant. As the conversion efficiency of the drive is approximately 99%, very little is wasted. This feature can be used to positive effect for haulage type systems, and can be a major selling feature. The regenerative DC drive is a highly flexible drive that can be applied to even the most arduous applications. High speed braking and reversing make it suitable for machine tool spindle drives, test rigs of all descriptions, winding applications where the reel is likely to be overhauled, out of balance loads, high speed textile machinery. It is also the case that where normal braking and some reverse facility is required, the installed cost of a 4 quadrant drive is likely to be less than fitting dynamic brake and reversing contactors, with single ended drives.

6. Standard And Non Standard Voltages.

All Bardac 3 phase drives are designed to operate with supply voltages of 190-250V or 380-500V, depending on the positions of the on-board supply voltage jumper links. The maximum output voltages from the drive will then be 1.1 x supply voltage for the armature and 0.9 x supply voltage for the field.

Occasionally motor voltages occur at values much lower than the available supply voltage. Although the average drive output can be limited to lower voltages by the on board presets, it is not recommended that this be done. For example, with a 415V supply the output may still contain 600V peaks, which when presented to a 110V DC motor, say, could break down the motor insulation. It is better to provide a low voltage AC supply to match the motor rating.

This can be done by feeding the main supply terminals at low voltage (e.g. 100V) from a suitable transformer, while still feeding the auxilliary supply direct from the mains (e.g. 415V). Circuits describing this are shown in the applications manual. The cost of the transformer is offset by the fact that no line reactor is required in this configuration.

7. Industry Applications For 3 Phase Drives.

Plastics.

Extruders Usually non regenerative, simple drives. Almost all request a zero reference interlock, which is a link to the zero speed relay to prevent re-starting at speed after a stop condition.

Blown Film Extrusion head as above.

Rubber Extruders - As plastic extruders.

Mixers - Non regenerative, simple drives, but with an exception. Most mixers operate under a duty cycle, say as follows:
Cycle 1 - 200% full load torque - 15 secs, Cycle 2 - 90% full load torque - 30 secs. Cycle 3 - 40% full load torque - 45 secs If we were to size the drive/motor for 100% torque it would trip on the first cycle. The RMS value of the duty must be considered.

Machine Tools

Spindle Drives. Mainly regenerative, usually controlled through a CNC system. Motors must be well protected against coolant and dirt. Most use field weakening for constant KW.

Feed drives Mainly regenerative, mostly in the single phase range.

Metals.

Rolling Mill Mainly regenerative due to reversing duty. Usually large KW arduous duty.

Slitting and Coil Winding Machines mainly regenerative, both slitters and coil winders. Slitting systems usually simple drives, coil winders can be complex.

Metal Forming M/c Mainly non regenerative, one converter driving the whole machine

Wire Drawing Usually multi drive systems, each section increasing in speed. Mainly regenerative, with increase motor speed controlled by field controller. Rewind is usually a bobbin, not DC controlled.

Cable production Combination of extruder and cable handling. Haul off is regenerative, along with rewind stands.

Bunchers and Stranders Generally regenerative in medium systems along with take up stand.

Paper and Board

Paper Production Usually large high cost control systems for complete paper machines. Mix of drives from large - small KW.

Board Production Mix of regenerative and non regenerative drives. Cutters usually regenerative medium sized systems.

Printing Presses. Almost invariably regenerative, and may require digital locking for print control, can be complex systems.

ReReelers and Slitters. Regenerative drives requiring accurate control of motor torque.

Test Rigs. Usually high response complex systems requiring fully regenerative drives, and utilising many of the drives control functions, torque, speed outputs etc.

Textiles.

Spinning Frames Usually regenerative drives for braking control. Drives systems fairly simple but modern computer control making the interface more complex. Non reversing.

Carding Machines. Can be non regenerative on simple card applications. Non reversing.

These application notes are strictly for assistance in the general implementation of Bardac products, and are provided for general guidance in system applications. It is entirely the users responsibility to ensure that any system is suitable for the application in question and all due care is taken with regard to overall safety of the installation. Bardac Drives does not accept any liability in respect of the application.

Section 5**Application diagrams for model SL**

Page	Drg.	Application
1	1	Armature voltage feedback
	2	Tacho feedback
	3	Dynamic braking
	4	Torque control
2	1	Digital panel meters showing speed and current
	2	Connection of motor thermistor
	3	Connection of auxiliary signal relays
	4	Using relay drivers for lamps
3	1	Drive healthy signal relay
	2	Control via open collector PLC outputs
	3	Remote setpoint
	4	Local or remote speed demand selected by pushbutton
4	1	Winding application using the 430 winder card
5	1	Master/slave speed follower
	2	Load sharing
6	1	Master setpoint to multiple drives using buffer card.
7	1	Linking drives together, one trips, all trip
	2	Power on interlock
	3	Motor thermistor
	4	Contactora in armature circuit
	5	Power on with maintained contact
8	1	Zero reference interlock
9	1	Reversing system
10	1	Simple dancing arm circuits
11	1	Jogging with main contactor permanently energised.
	2	Jogging with start and power on functions combined
	3	Crawl or run select. Coasting down
	4	Jogging on main contactor
12	1	Jogging with main contactor energised via direct speed input
	2	External jog speed reference with start and power on functions combined
	3	Crawl or run select. Ramping down.
	4	Jogging on main contactor with zero speed interlock
13	1	MICRO ANALOG PROCESSOR
		Signal pad listing
14		Braking (Regenerative braking is only possible on models up to SL50)
	1	Jogging with main contactor energised via direct speed input and regenerative braking
	2	External jog with start and power on functions combined and regenerative braking
	3	Coasting/braking contact
15	4	Crawl or run select with brake enable switch
	1	Ramping to crawl triggered by proximity detector, then coasting to zero by run contact
	2	Ramping to crawl triggered by proximity detector, then ramping to zero
	3	Braking to zero speed triggered by end limit switch
16	4	Main contactor drop out enabled by zero speed
	1	Low voltage supply with auxiliary supply step up transformer
17	2	AC supply with step down transformer for the power connections
17	1	Local transformer power supplies
		Power supply condition
18	1	EMC installation guidelines

1) BASIC CONNECTION. ARMATURE VOLTAGE FEEDBACK

FOR HIGH ACCURACY ARMATURE VOLTAGE FEEDBACK THE FIELD REGULATOR MUST BE PRESET IN LINEAR MODE
EXTERNAL IR COMPENSATION MAY BE NECESSARY FOR IMPROVED LOAD REGULATION. INCREASE THE IR COMP TO OVERCOME SPEED DROOP
AT FULL LOAD. EXCESSIVE IR COMP MAY LEAD TO INSTABILITY

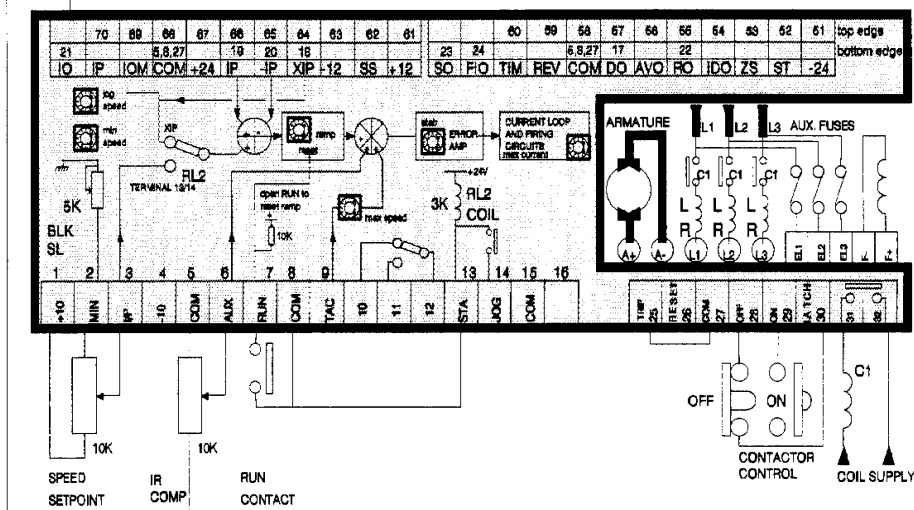

2) BASIC CONNECTION. TACHO FEEDBACK

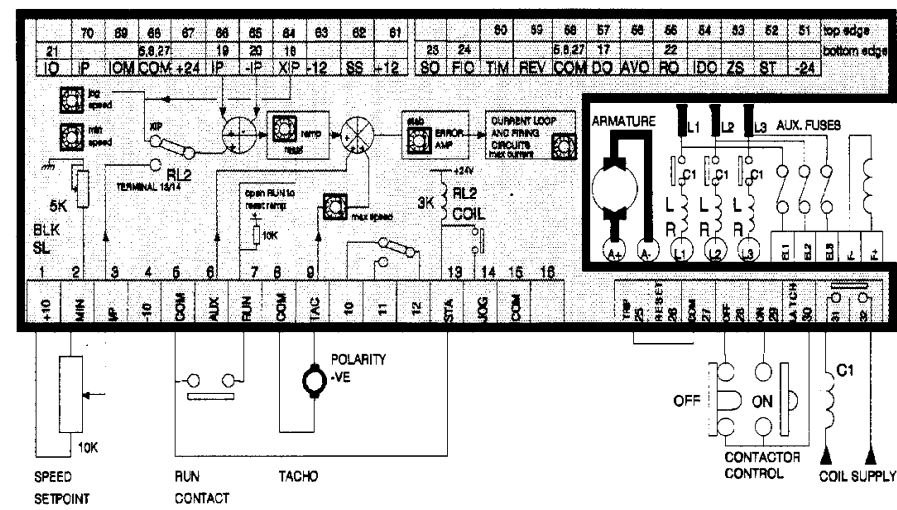

3) BASIC CONNECTION. DYNAMIC BRAKING

C1 normally open. C2 normally closed. The relays operate together.
the peak breaking current should not exceed 3 times the nominal armature current the resistor must be able to dissipate the waste heat.

HIGH POWER DB
RESISTOR ASSEMBLY
IS STOCK ITEM please
refer to supplier

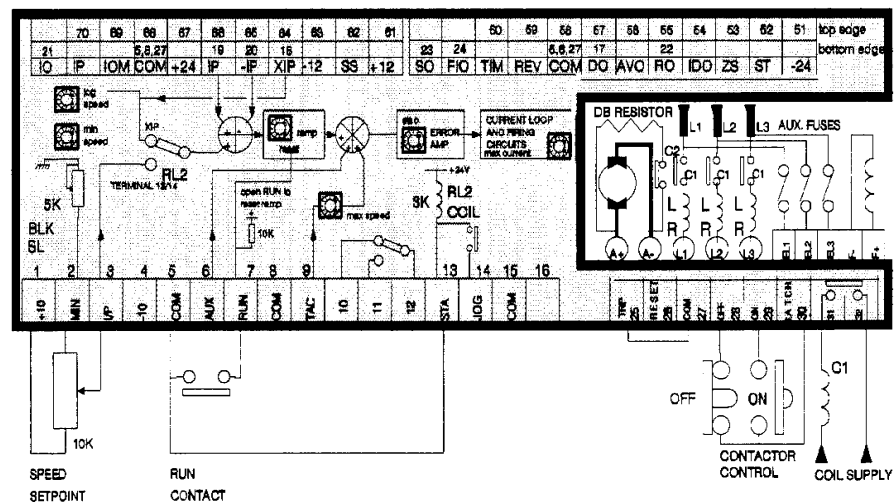

4) TORQUE CONTROL, OVERSPEED LIMITING BY SEPERATE SPEED SETPOINT

If the speed exceeds the level programmed by the speed setpoint, then the current demand comes out of limit and the speed loop takes control.

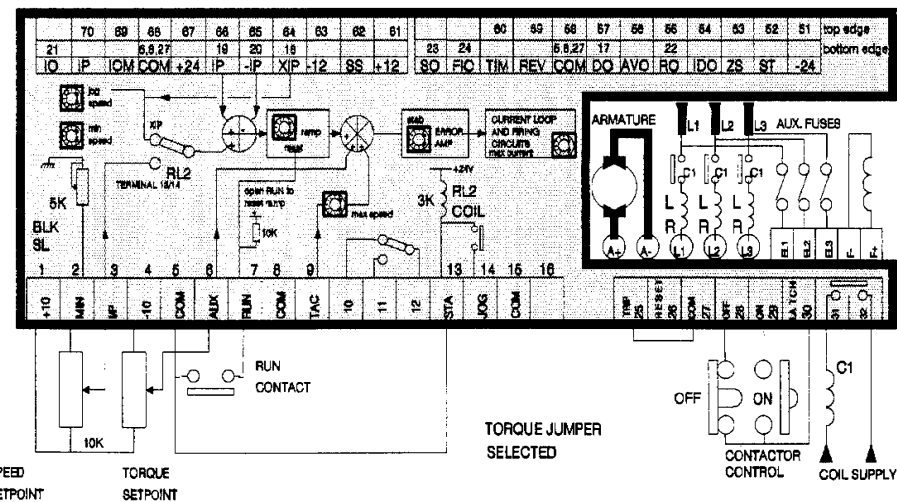

BASIC CONNECTIONS. MODEL SL

- 1) Armature voltage feedback
- 2) Tacho feedback
- 3) Dynamic braking
- 4) Torque control



1994

BARDAC CORP. DOES NOT ACCEPT ANY LIABILITY WHATSOEVER FOR THE INSTALLATION, FITNESS FOR PURPOSE OR APPLICATION OF ITS PRODUCTS. IT IS THE USER'S RESPONSIBILITY TO ENSURE THE UNIT IS CORRECTLY USED AND INSTALLED.

HEALTH AND SAFETY AT WORK. ELECTRICAL DEVICES CONSTITUTE A SAFETY HAZARD. IT IS THE RESPONSIBILITY OF THE USER TO ENSURE COMPLIANCE WITH ANY ACTS OR BYLAWS IN FORCE. ONLY SKILLED PERSONS SHOULD INSTALL THIS EQUIPMENT.

1) DIGITAL PANEL METERS TYPE 35S USED TO SHOW SPEED AND CURRENT

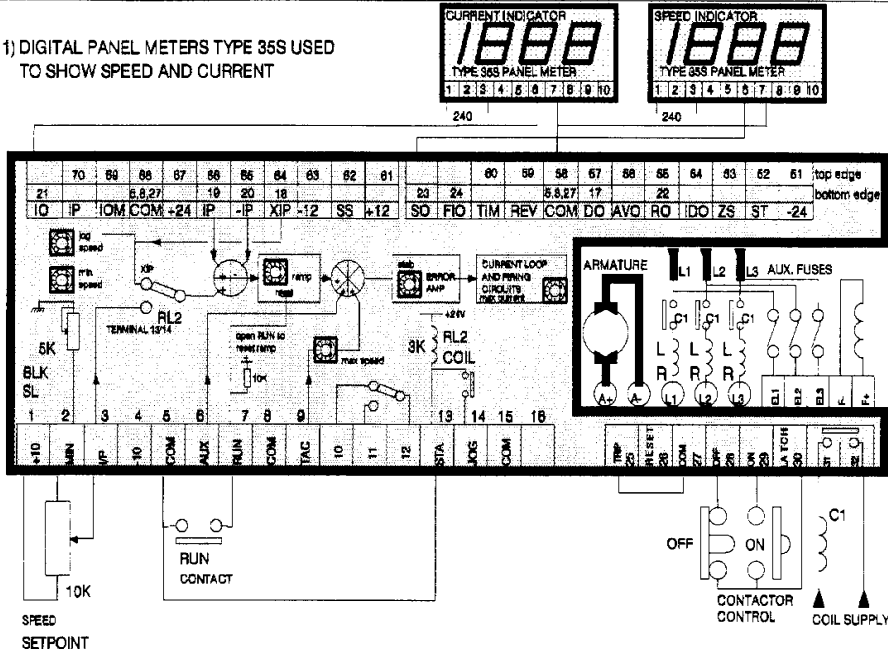

2) MOTOR THERMISTOR CONNECTION. THE AUX ALARM WILL TRIGGER IF THE RESISTANCE OF THE THERMISTOR EXCEEDS 2K Ohms. THE ALARM WILL NOT TRIGGER IF THE RESISTANCE OF THE THERMISTOR REMAINS BELOW 200 Ohms.

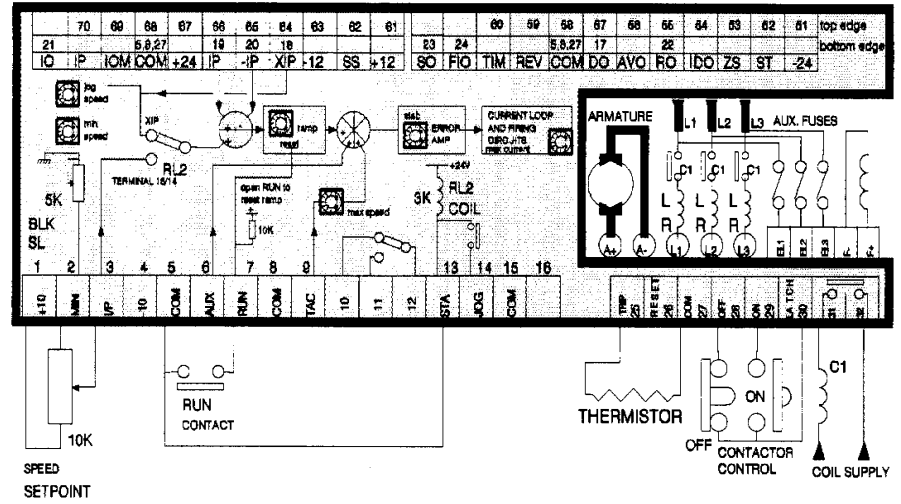

3) CONNECTION OF AUXILIARY SIGNAL RELAY. minimum coil resistance 1K. STALL, ZERO, REVERSE and TIMER functions available on terminals 52/53/59/60. They are also switch selectable functions for the on board relay

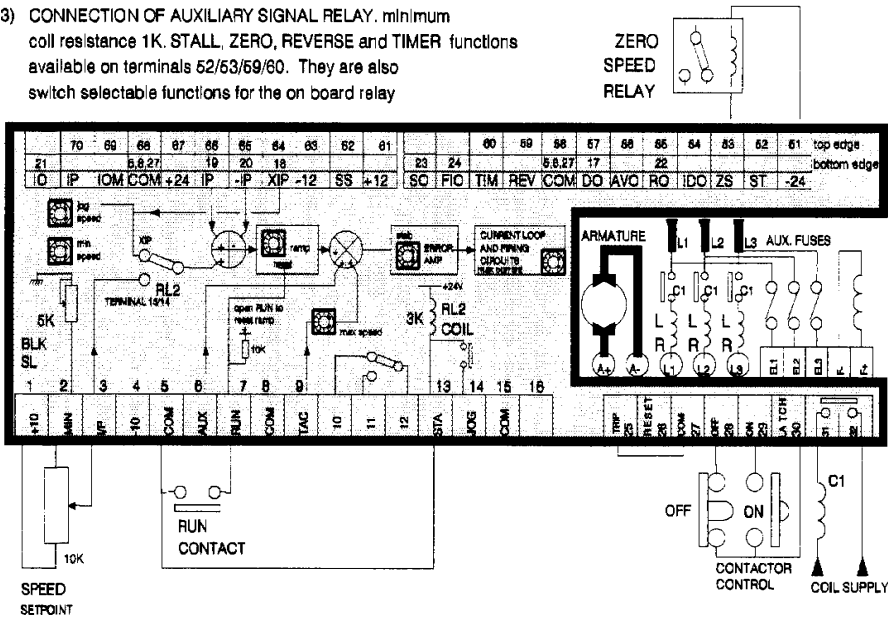

4) USING RELAY DRIVERS FOR LAMPS The relay drivers may also drive various types of indicators. Shown here are 3 types. The lamps must be 24V 25mA. Max. total 25mA.

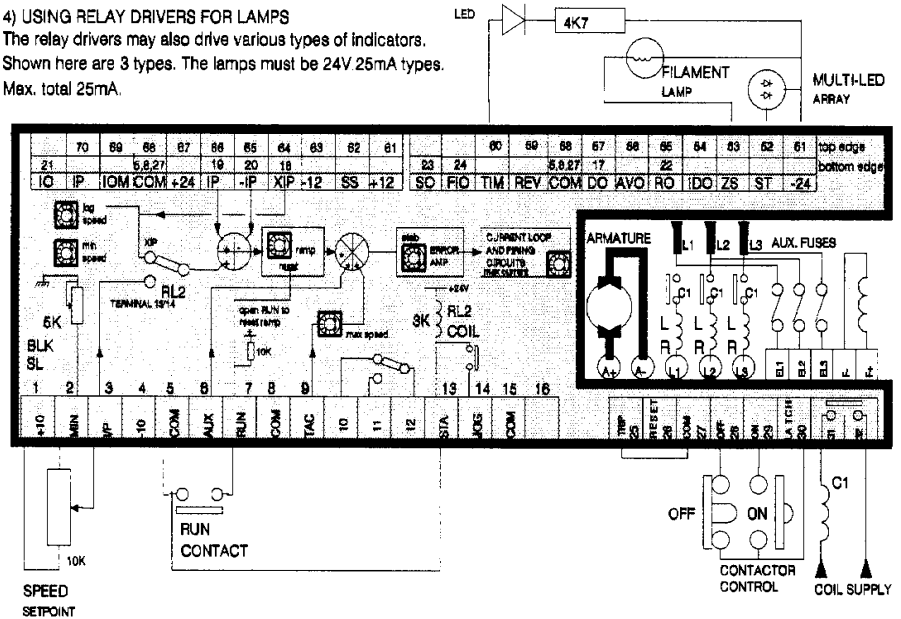

**BASIC CONNECTIONS
MODEL SL**

- 1) Digital panel meters showing speed and current
- 2) Connection of motor thermistor
- 3) Connection of auxiliary signal relays
- 4) Using relay drivers for lamps



1994

BARDAC CORP. DOES NOT ACCEPT ANY LIABILITY WHATSOEVER FOR THE INSTALLATION, FITNESS FOR PURPOSE OR APPLICATION OF ITS PRODUCTS. IT IS THE USERS RESPONSIBILITY TO ENSURE THE UNIT IS CORRECTLY USED AND INSTALLED.

HEALTH AND SAFETY AT WORK. ELECTRICAL DEVICES CONSTITUTE A SAFETY HAZARD. IT IS THE RESPONSIBILITY OF THE USER TO ENSURE COMPLIANCE WITH ANY ACTS OR BYLAWS IN FORCE. ONLY SKILLED PERSONS SHOULD INSTALL THIS EQUIPMENT.

1) DRIVE HEALTHY SIGNAL RELAY

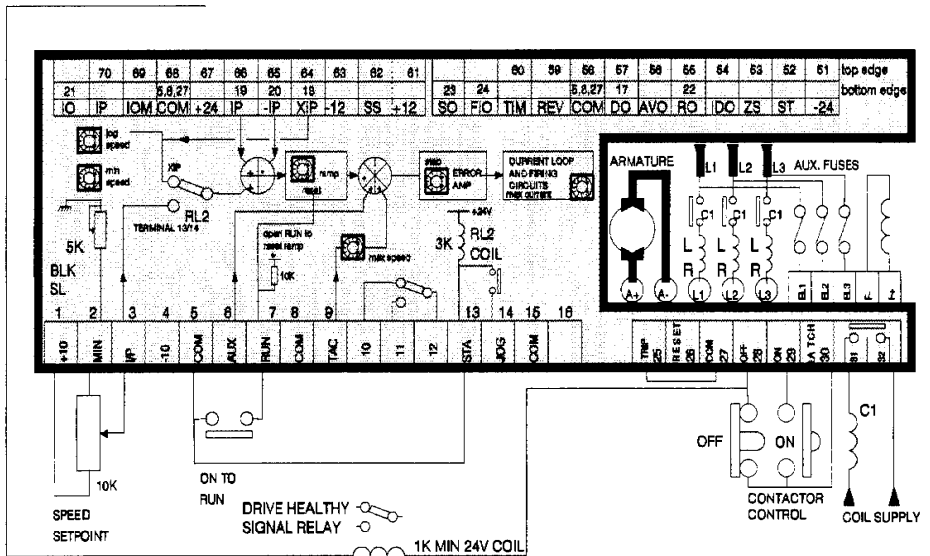

2) CONTROL VIA OPEN COLLECTOR PLC OUTPUTS

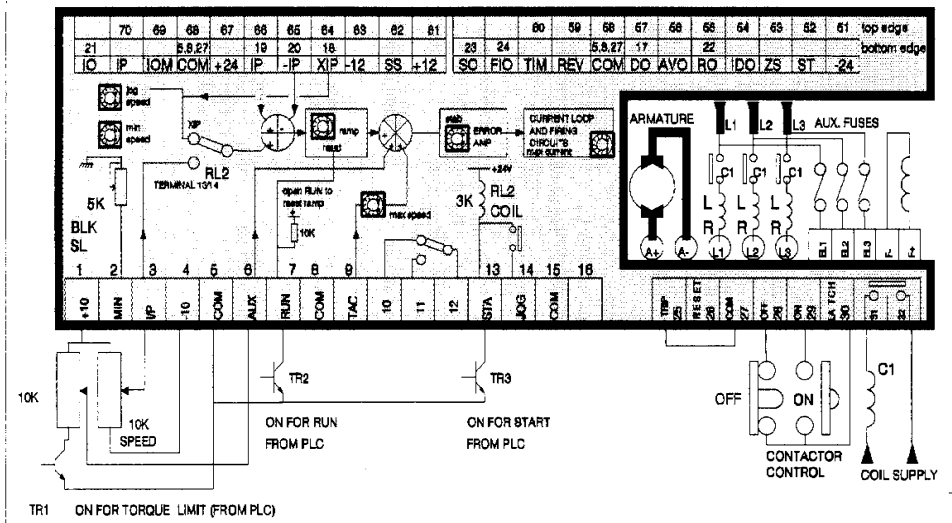

3) THE DRIVE SPEED IS SET BY A REMOTE 0 TO +10 VOLT SIGNAL.

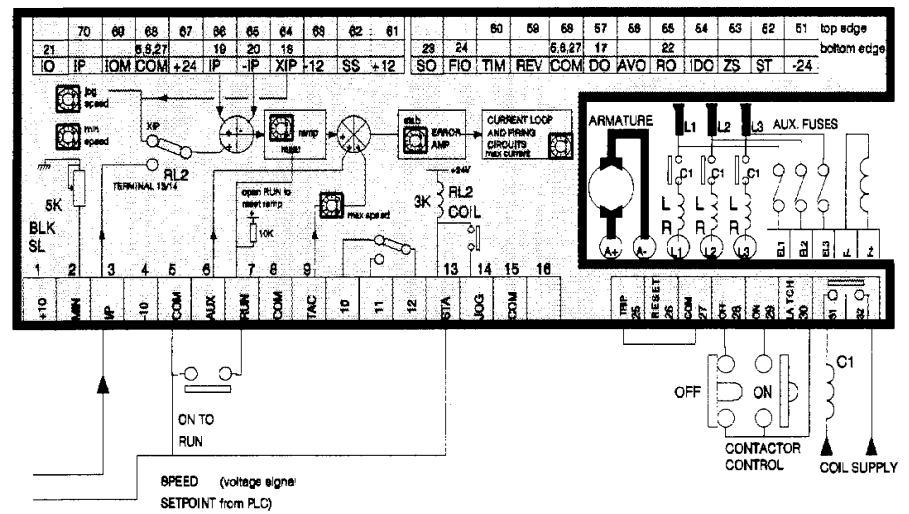

4) LOCAL OR REMOTE SPEED DEMAND SELECTED BY PUSHBUTTON, THE DRIVE WILL RAMP BETWEEN THE SETPOINTS.

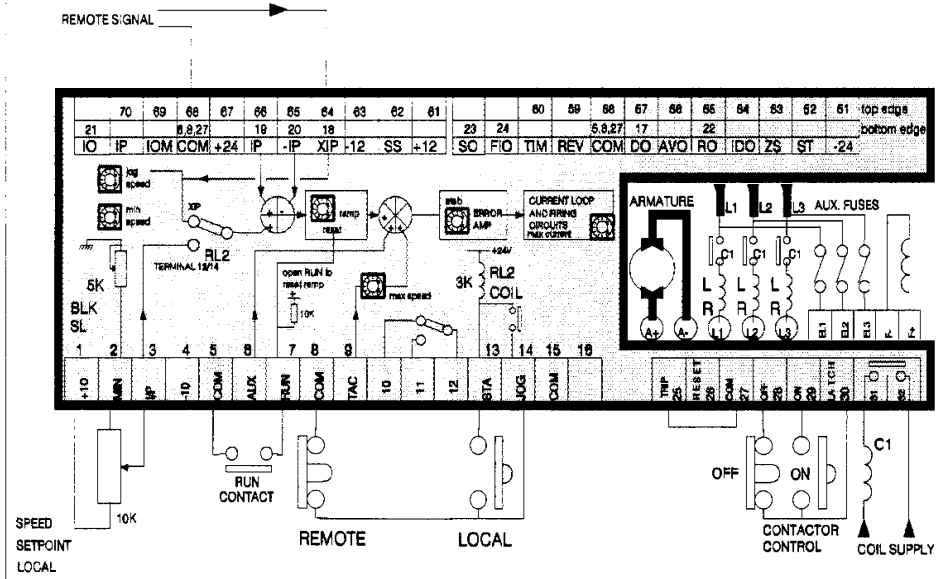

- BASIC CONNECTIONS MODEL SL**
- 1) Drive healthy signal relay
 - 2) Control by open collector PLC outputs
 - 3) Remote setpoint
 - 4) Local or remote speed demand selected by pushbutton

1994

BARDAC CORP. DOES NOT ACCEPT ANY LIABILITY WHATSOEVER FOR THE INSTALLATION, FITNESS FOR PURPOSE OR APPLICATION OF ITS PRODUCTS. IT IS THE USER'S RESPONSIBILITY TO ENSURE THE UNIT IS CORRECTLY USED AND INSTALLED.

HEALTH AND SAFETY AT WORK. ELECTRICAL DEVICES CONSTITUTE A SAFETY HAZARD. IT IS THE RESPONSIBILITY OF THE USER TO ENSURE COMPLIANCE WITH ANY ACTS OR BYLAWS IN FORCE. ONLY SKILLED PERSONS SHOULD INSTALL THIS EQUIPMENT.

WEB DRIVE IN SPEED MODE

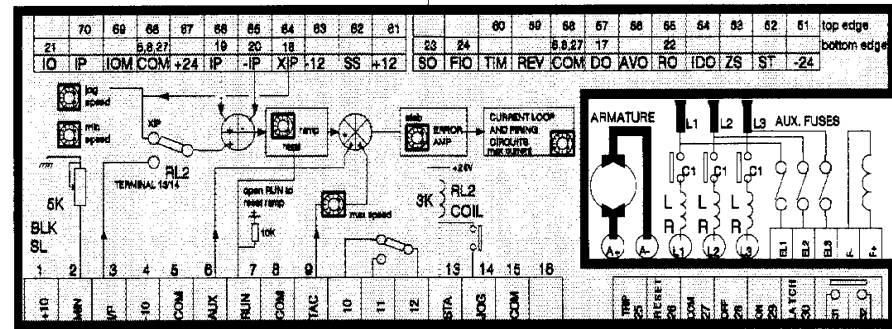

SET ZERO SPEED CLOCKWISE TO GIVE POSITIVE SPEED OFFSET

REEL DRIVE IN TORQUE MODE

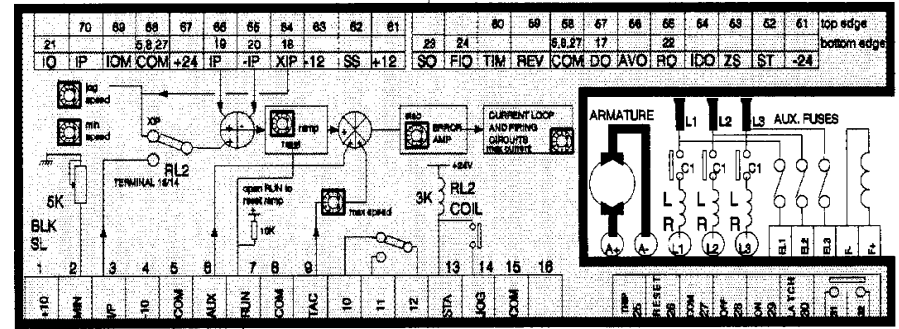

WEB SPEED

CLOSE TO RUN

100% CURRENT DEMAND

JOG

REEL DRIVE MUST BE IN TORQUE MODE. THE 100% SPEED SCALING SHOULD ACCOMMODATE THE MAXIMUM WEB SPEED AT MINIMUM DIAMETER. (SET THIS UP FIRST IN SPEED MODE INITIALLY)

CURRENT DEMAND FROM WINDER UNIT

THE RELAY CAN BE USED TO INDICATE THAT THE REEL SPEED IS BELOW THE THRESHOLD FOR CALCULATION. THIS CAN EASILY HAPPEN EG. FOR A 10:1 DIAMETER CHANGE AND A 2.5% THRESHOLD THE DIAMETER CALCULATION WILL HOLD AT 25% OF LINE SPEED WHEN THE REEL IS NEARLY FULL

EXTERNAL TAPER ADJUST

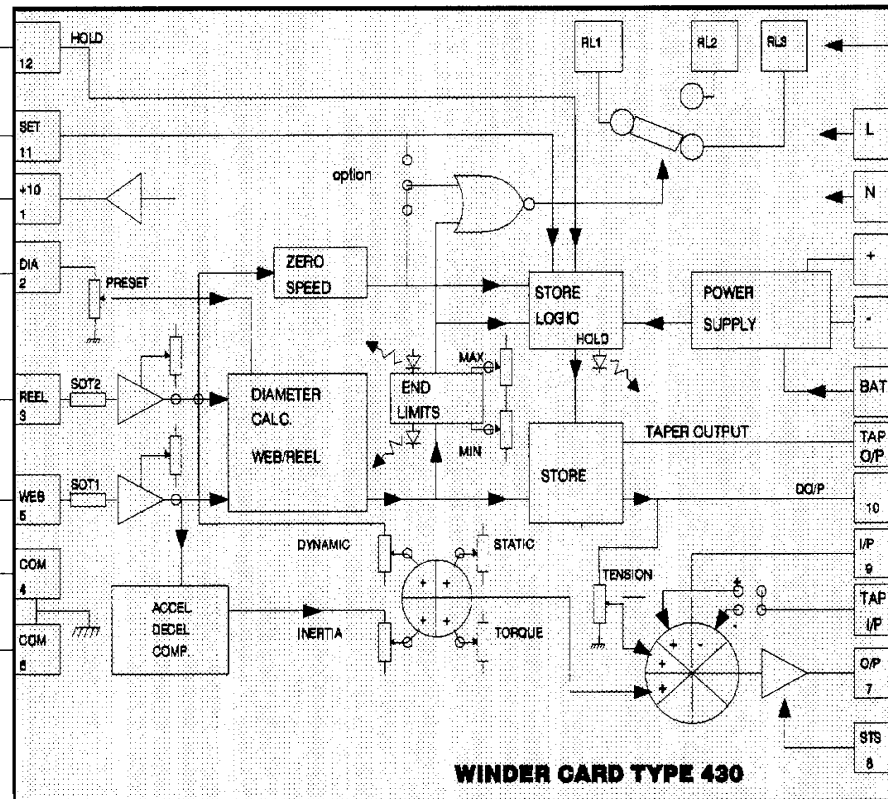

WINDER CARD TYPE 430

WINDER APPLICATION. MODEL SL

BARDAC CORP. DOES NOT ACCEPT ANY LIABILITY WHATSOEVER FOR THE INSTALLATION, FITNESS FOR PURPOSE OR APPLICATION OF ITS PRODUCTS. IT IS THE USER'S RESPONSIBILITY TO ENSURE THE UNIT IS CORRECTLY USED AND INSTALLED. HEALTH AND SAFETY AT WORK. ELECTRICAL DEVICES CONSTITUTE A SAFETY HAZARD. IT IS THE RESPONSIBILITY OF THE USER TO ENSURE COMPLIANCE WITH ANY ACTS OR BYLAWS IN FORCE. ONLY SKILLED PERSONS SHOULD INSTALL THIS EQUIPMENT.



1994

1) MASTER DRIVE WITH SLAVE FOLLOWING IN SPEED MODE. THE SPEED DEMAND FOR THE SLAVE CAN BE SELECTED TO BE THE RAMP OUTPUT FROM THE MASTER.

MASTER DRIVE

SLAVE FOLLOWER OR A LOCAL POT.

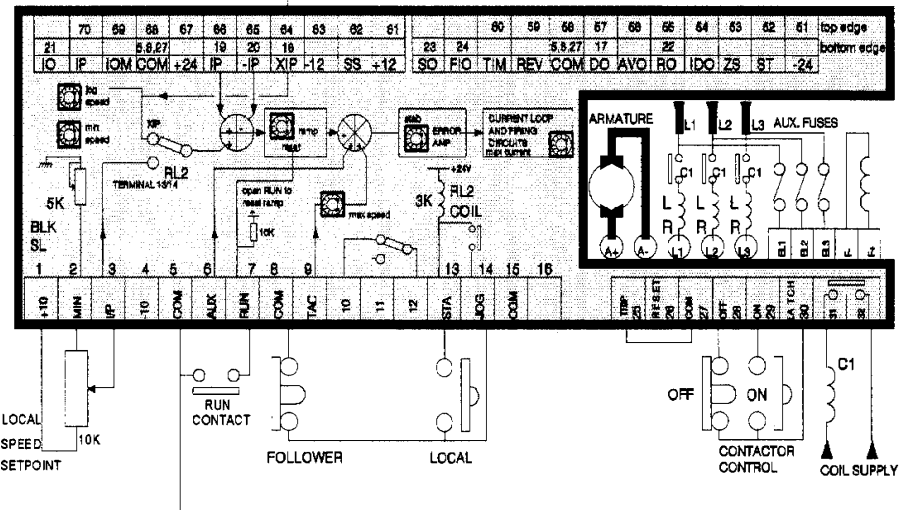
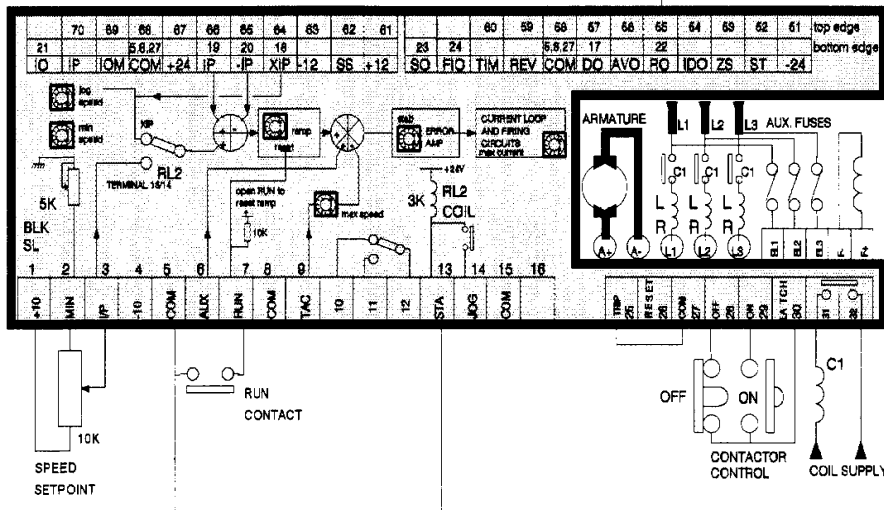

2) LOAD SHARING WITH TWO MOTORS MECHANICALLY LOCKED. THE MODULUS CURRENT OUTPUT SIGNAL FROM THE MASTER PROVIDES A TORQUE DEMAND INPUT TO THE SLAVE. THE SPEED LOOP OF THE SLAVE IS OFFSET POSITIVELY FOR OVERSPEED PROTECTION.

Make speed scaling of both drives matched then adjust ZERO SPEED clockwise to give positive offset to speed demand

Solder a resistor value < 1KOhm between pin 31 and pin 37 on the MICRO ANALOG PROCESSOR of the slave to rescale the 100% torque demand level to 5V. The slave must be in TORQUE mode. See section 5 page 13 for details of the MICRO ANALOG PROCESSOR.

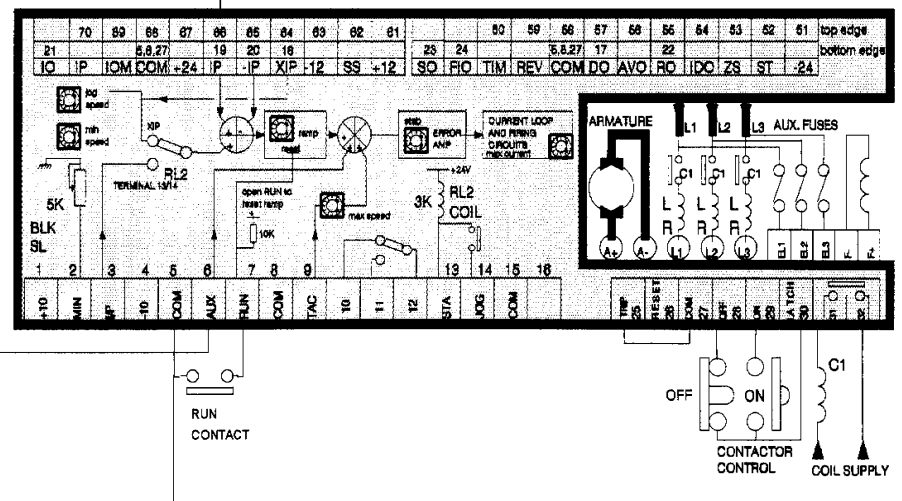
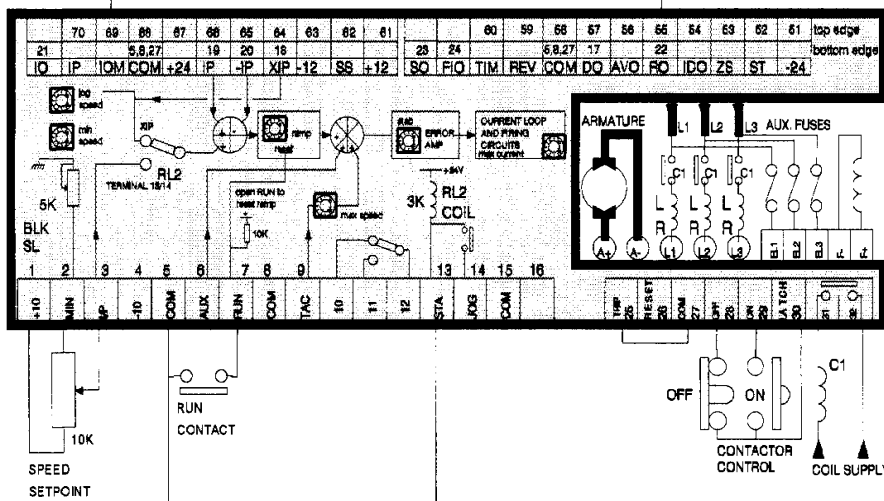

MODEL SL

- 1) SPEED FOLLOWING SCHEME.
- 2) LOAD SHARING

BARDAC CORP. DOES NOT ACCEPT ANY LIABILITY WHATSOEVER FOR THE INSTALLATION, FITNESS FOR PURPOSE OR APPLICATION OF ITS PRODUCTS. IT IS THE USER'S RESPONSIBILITY TO ENSURE THE UNIT IS CORRECTLY USED AND INSTALLED.

HEALTH AND SAFETY AT WORK: ELECTRICAL DEVICES CONSTITUTE A SAFETY HAZARD. IT IS THE RESPONSIBILITY OF THE USER TO ENSURE COMPLIANCE WITH ANY ACTS OR BYLAWS IN FORCE. ONLY SKILLED PERSONS SHOULD INSTALL THIS EQUIPMENT.

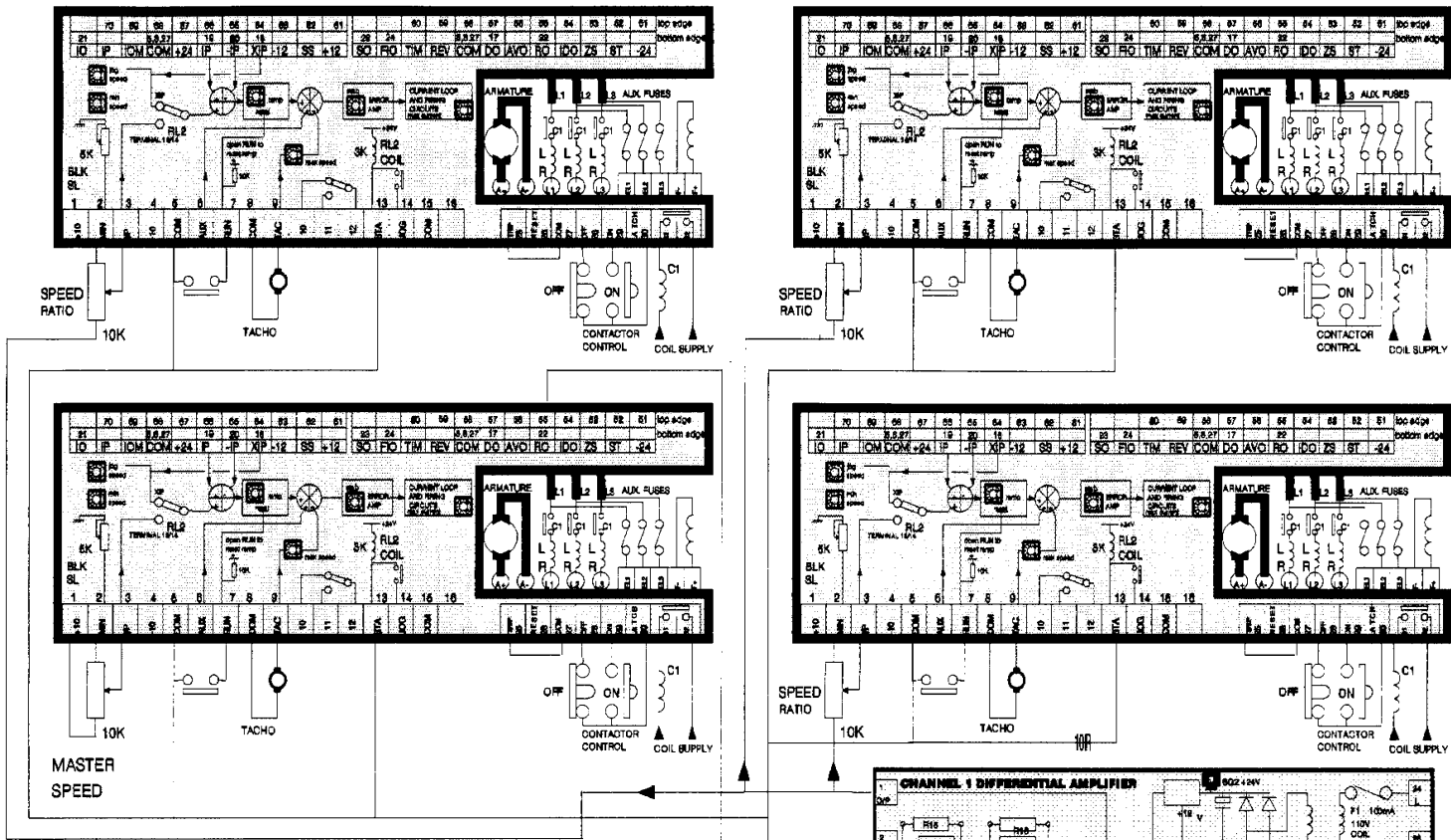

THE RAMP SETTINGS ON THIS DRIVE WILL BE FOLLOWED BY THE OTHERS

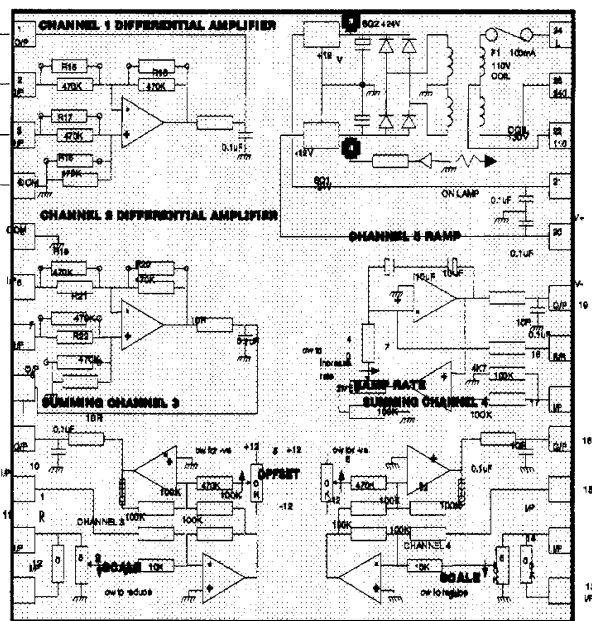

THIS DRAWING SHOWS HOW THE BUFFER CARD CAN BE USED TO PROVIDE A MASTER SETPOINT TO MULTIPLE DRIVES WITH A RATIO POT FOR EACH OF THE FOLLOWERS. Only one channel is needed to drive 3 slaves.

**Master Setpoint application.
Model SL**

BARDAC CORP. DOES NOT ACCEPT ANY LIABILITY WHATSOEVER FOR THE INSTALLATION, FITNESS FOR PURPOSE OR APPLICATION OF ITS PRODUCTS. IT IS THE USER'S RESPONSIBILITY TO ENSURE THE UNIT IS CORRECTLY USED AND INSTALLED.

HEALTH AND SAFETY AT WORK. ELECTRICAL DEVICES CONSTITUTE A SAFETY HAZARD. IT IS THE RESPONSIBILITY OF THE USER TO ENSURE COMPLIANCE WITH ANY ACTS OR BYLAWS IN FORCE. ONLY SKILLED PERSONS SHOULD INSTALL THIS EQUIPMENT.

1 METHOD FOR ENABLING POWER ON FOR MULTIPLE DRIVES WITH ONE SET OF POWER ON, POWER OFF PUSHBUTTONS. NOTE. THE PROPOGATION DELAY FOR TRIPPING IS APPROX. 100 millsecs. PER DRIVE. (note, the main contactor can be rated AC1, thermal. The phase loss detection is enabled on drive A for all drives on the same auxillary supplies)

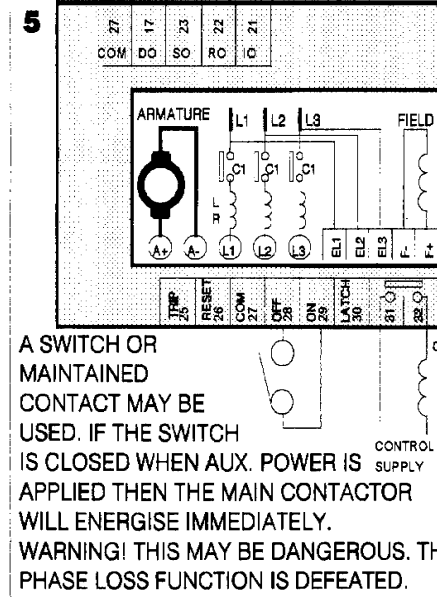
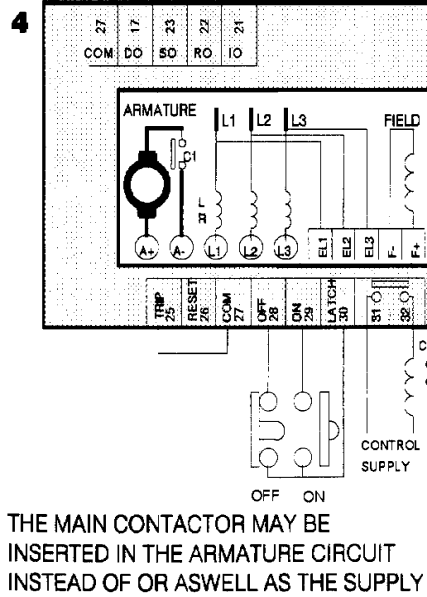
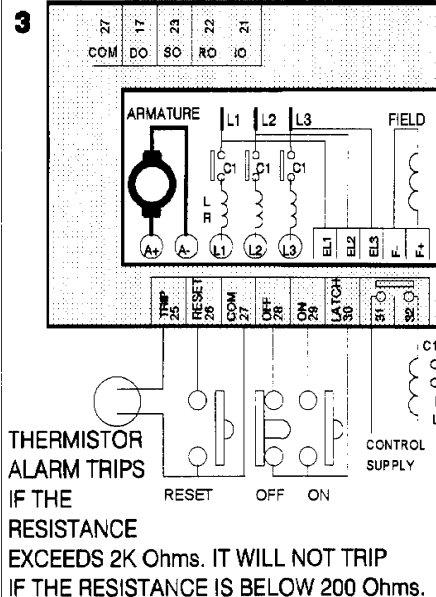
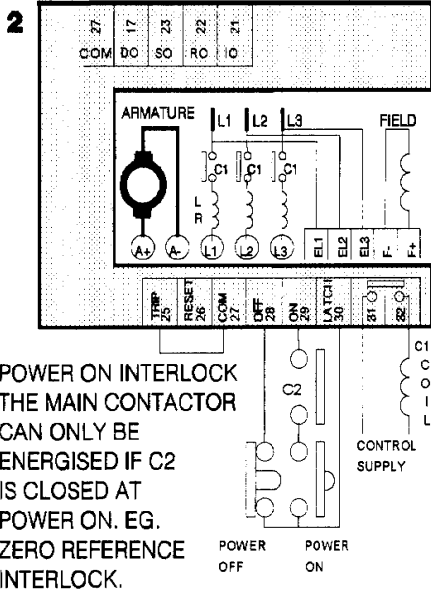
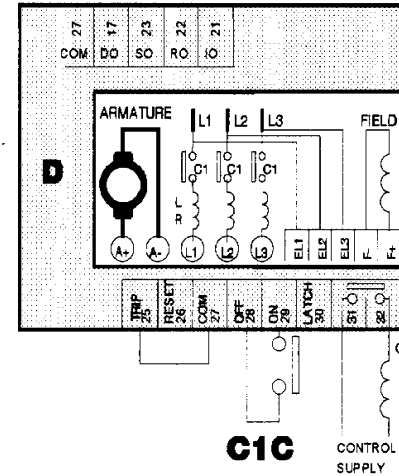
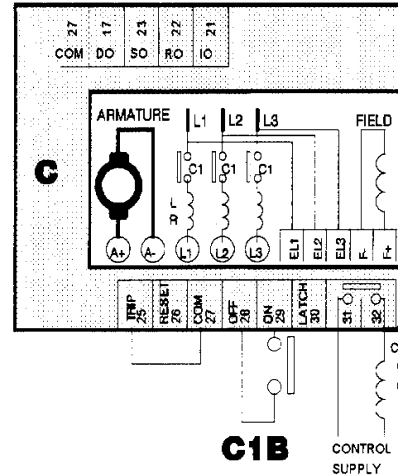
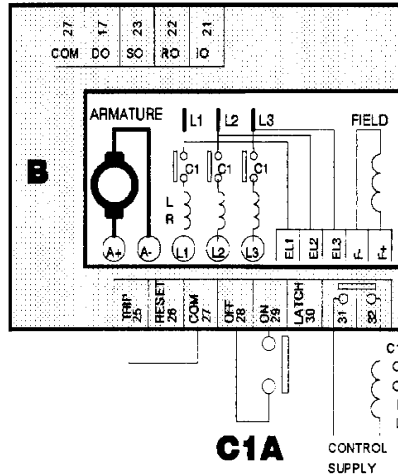
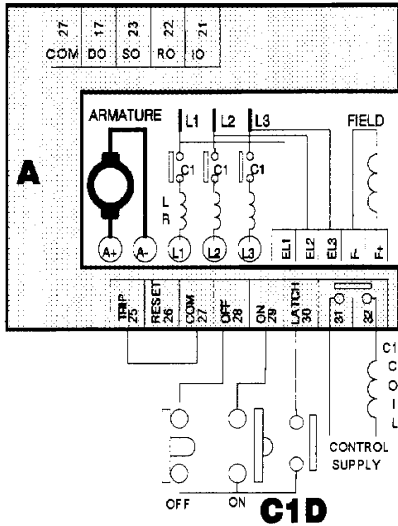

1) Linking Drives together, one trips, all trip.
2) Power On Interlock.
3) Thermistor with Reset button.

4) Contactor in Armature circuit.
5) Power On with maintained contact.

HEALTH AND SAFETY AT WORK. ELECTRICAL DEVICES CONSTITUTE A SAFETY HAZARD. IT IS THE RESPONSIBILITY OF THE USER TO ENSURE COMPLIANCE WITH ANY ACTS OR BYLAWS IN FORCE. ONLY SKILLED PERSONS SHOULD INSTALL THIS EQUIPMENT.

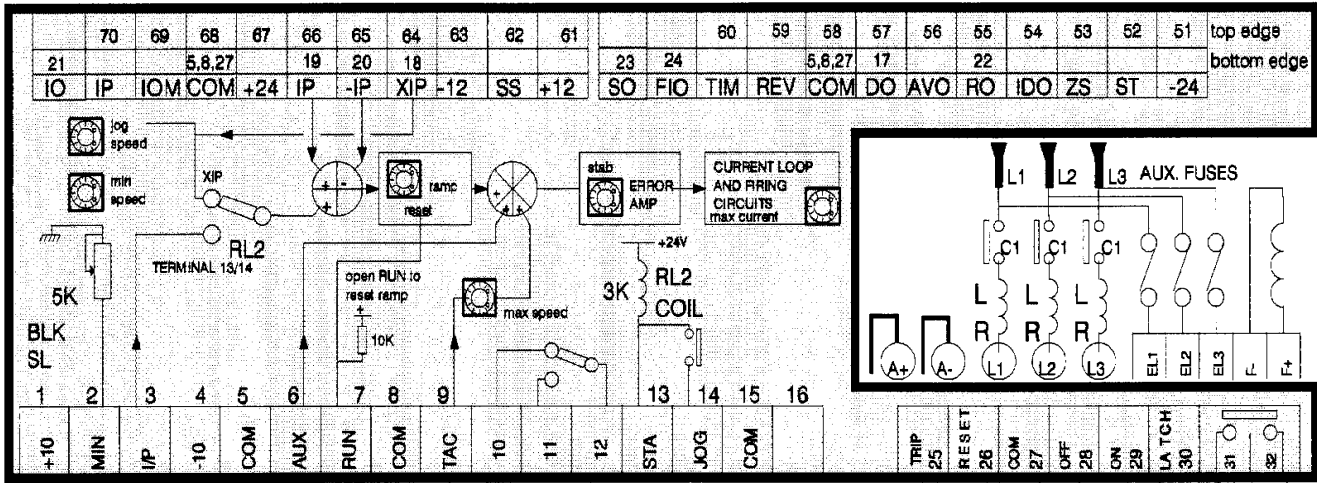

MODE OF OPERATION

- 1) C1 and C2 are initially de-energised
- 2) When FWD is selected, the aux FWD contact and the zero speed relay enable the drive slave contact on T31/32 to latch on, energising the C1 coil via aux C2a.
- 3) The C1 coil latches itself on via C1b and the motor rotates forward with the DB resistor off.
- 4) When power off is selected, the drive slave contact on T31/32 opens. C1 de-energises and the DB resistor is connected across the armature.
- 5) The REV function cannot be selected until the zero speed relay de-energises at a speed < 1%.
- 6) The sequence is repeated for REVERSE in a similar fashion.
- 7) If AV feedback is used it may be necessary to put a 47K 5W resistor across A+ A- to ensure the correct operation of the internal zero detector.
- 8) If tacho feedback is used then the tacho signal will need to be reversed.

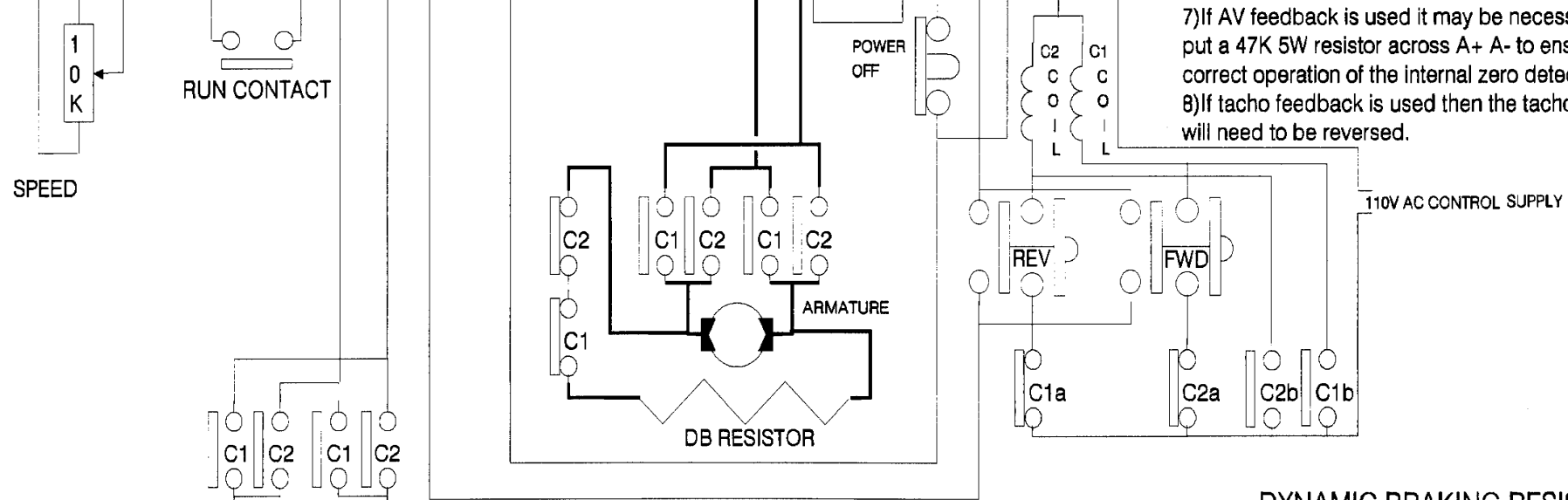

SELECT RL1 ZERO SPEED RELAY FUNCTION WITH S8 ON AND S2/5 OFF.

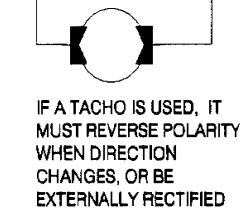

IF A TACHO IS USED, IT MUST REVERSE POLARITY WHEN DIRECTION CHANGES, OR BE EXTERNALLY RECTIFIED

ARMATURE REVERSAL WITH DYNAMIC BRAKING.
NOTE, FOR SYSTEMS INVOLVING FREQUENT OR RAPID REVERSAL AND OR BRAKING, IT IS RECOMMENDED THAT THE 4 QUADRANT SLX MODEL BE USED.

DYNAMIC BRAKING RESISTORS
 Sprint Electric stocks a purpose designed high capacity DB unit with adjustable Kw rating. Please refer to your supplier for details.

BARDAC CORP. DOES NOT ACCEPT ANY LIABILITY WHATSOEVER FOR THE INSTALLATION, FITNESS FOR PURPOSE OR APPLICATION OF ITS PRODUCTS. IT IS THE USER'S RESPONSIBILITY TO ENSURE THE UNIT IS CORRECTLY USED AND INSTALLED.

HEALTH AND SAFETY AT WORK. ELECTRICAL DEVICES CONSTITUTE A SAFETY HAZARD. IT IS THE RESPONSIBILITY OF THE USER TO ENSURE COMPLIANCE WITH ANY ACTS OR BYLAWS IN FORCE. ONLY SKILLED PERSONS SHOULD INSTALL THIS EQUIPMENT.

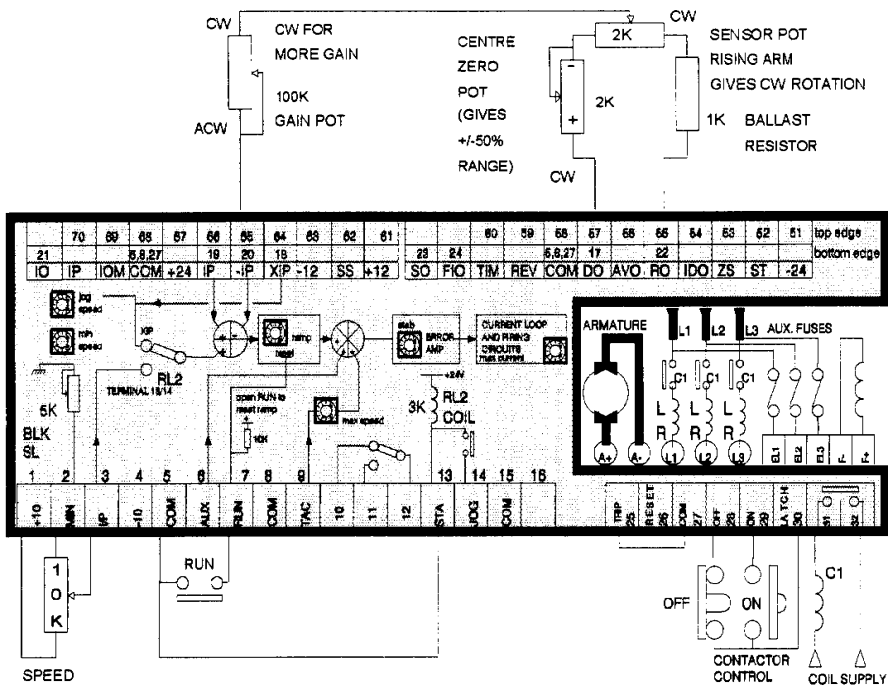

APPLICATION UTILISING DANCING ARM

THE CONTROL SYSTEM IS DESIGNED TO GIVE PROPORTIONAL CLOSED LOOP CONTROL OF THE POSITION OF THE DANCING ARM

THE POSITIVE SETPOINT RAMP OUTPUT AND THE NEGATIVE SETPOINT OUTPUT ARE APPLIED ACROSS THE SENSOR POT. THIS GIVES A SENSOR POT STRENGTH PROPORTIONAL TO LINE SPEED.

THE CENTRE ZERO POT AND BALLAST RESISTOR ALLOW ADJUSTMENT OF THE NULL POSITION BY +/-50% OF THE SENSOR POT TRAVEL. THEY CAN BE OMITTED IF THIS FUNCTION IS NOT WANTED

THE GAIN POT ALLOWS ADJUSTMENT OF THE SENSOR POT SIGNAL STRENGTH BY 50% TO ALLOW STABILITY ADJUSTMENT AND/OR GAIN CONTROL. HIGHER GAIN GIVES TIGHTER CONTROL BUT LESS STABILITY.

IF THE ARM STARTS TO RISE THE DRIVE RECEIVES A +VE SIGNAL INTO THE INVERTING \bar{V}/P , THIS GIVES A SPEED REDUCTION, WHICH CAUSES THE ARM TO RETURN TO THE NULL POSITION. A DROPPING ARM GIVES A SPEED INCREASE.

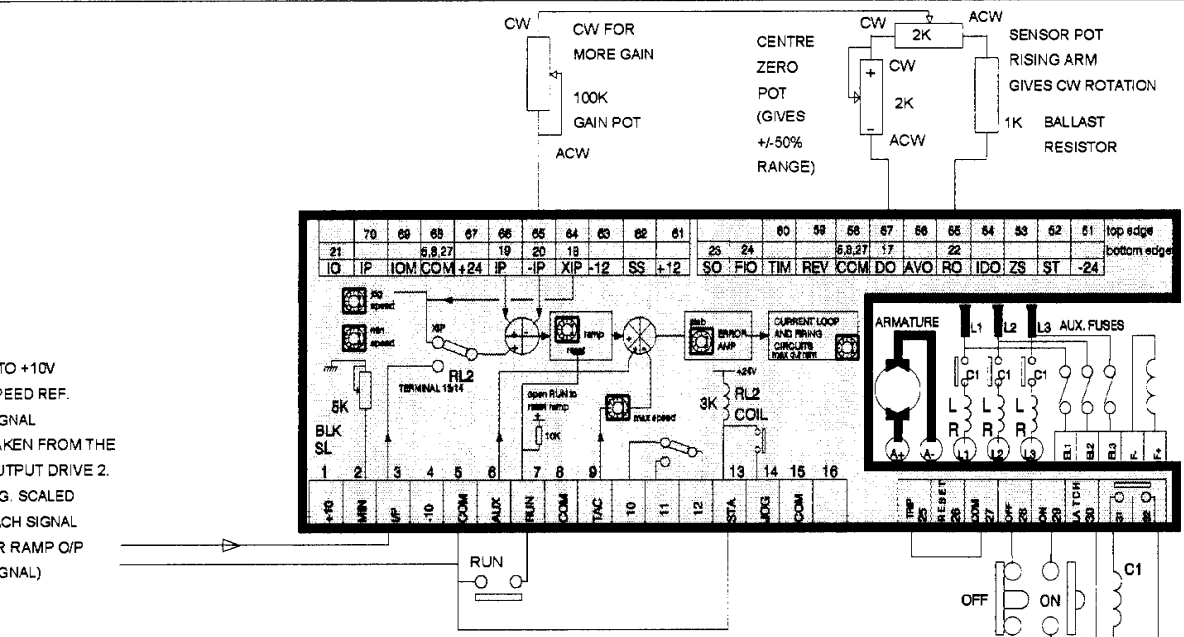
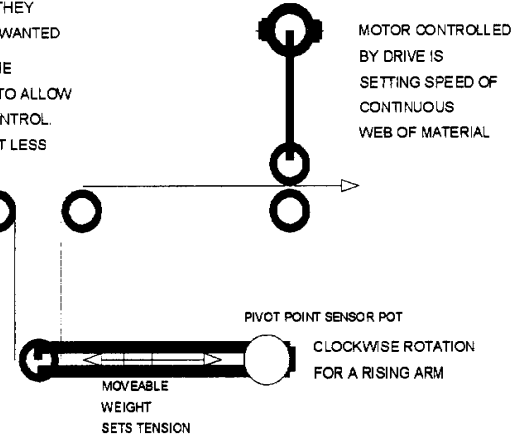

APPLICATION WHERE DANCING ARM POSITION IS CONTROLLED BY INPUT SPEED CHANGE

MOTOR CONTROLLED BY DRIVE IS SETTING SPEED OF CONTINUOUS WEB OF MATERIAL ON THE INPUT TO THE DANCING ARM

INDEPENDANT MOTOR SETTING SPEED OF MATERIAL OF OUTPUT OF DANCING ARM

PIVOT POINT SENSOR POT

CLOCKWISE ROTATION FOR A RISING ARM

MOVEABLE WEIGHT SETS TENSION

IN THIS CASE A RISING ARM CAUSES THE INPUT DRIVE 1 SPEED TO INCREASE

0 TO +10V SPEED REF. SIGNAL TAKEN FROM THE OUTPUT DRIVE 2. (EG. SCALED TACH SIGNAL OR RAMP O/P SIGNAL)

8/94	SL
ug101872 ISS10	
SIMPLE DANCING ARM	



BARDAC CORP. DOES NOT ACCEPT ANY LIABILITY WHATSOEVER FOR THE INSTALLATION, FITNESS FOR PURPOSE OR APPLICATION OF ITS PRODUCTS. IT IS THE USER'S RESPONSIBILITY TO ENSURE THE UNIT IS CORRECTLY USED AND INSTALLED.

HEALTH AND SAFETY AT WORK. ELECTRICAL DEVICES CONSTITUTE A SAFETY HAZARD. IT IS THE RESPONSIBILITY OF THE USER TO ENSURE COMPLIANCE WITH ANY ACTS OR BYLAWS IN FORCE. ONLY SKILLED PERSONS SHOULD INSTALL THIS EQUIPMENT.

1) THE JOG BUTTON WILL RAMP THE DRIVE DOWN TO STANDSTILL IF MOMENTARILY PRESSED, AND THEN CONTINUE TO JOG AT THE XIP SPEED.

2) CONTACTOR REMAINS ENERGISED DURING JOG. THE POWER ON AND START FUNCTIONS ARE COMBINED.

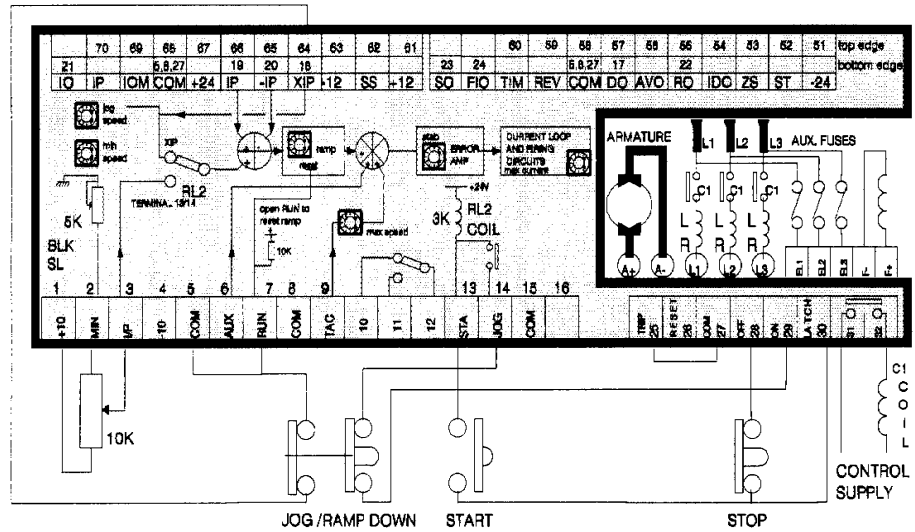
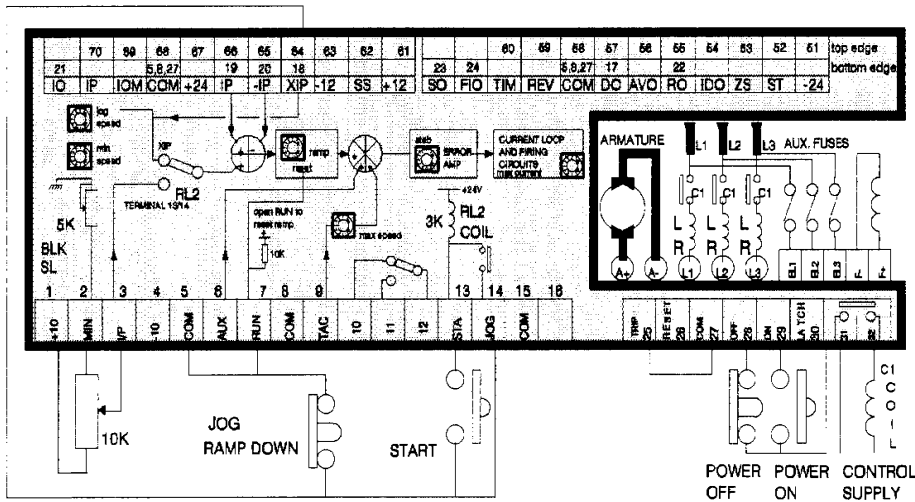

3) CRAWL OR RUN SELECT. COAST DOWN.

4) JOGGING ON MAIN CONTACTOR.
Reduce speed to minimum before selecting jog

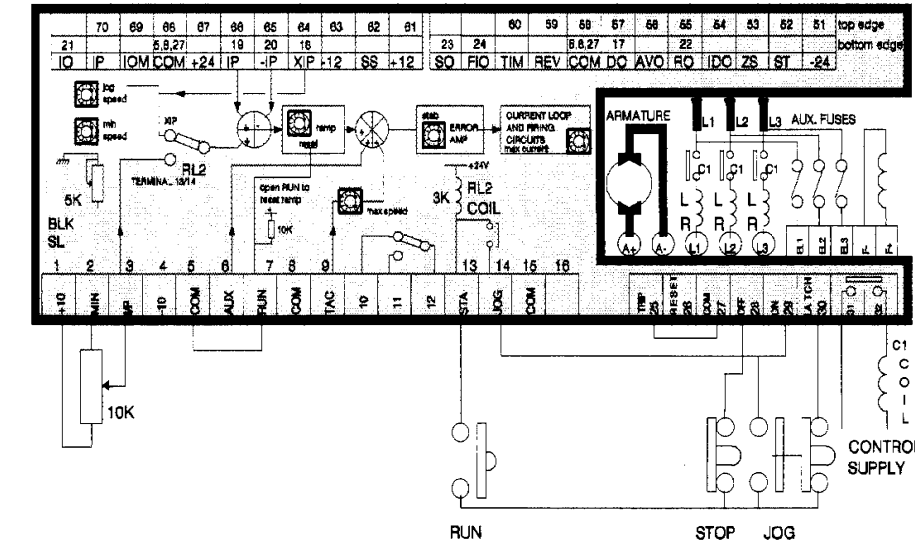
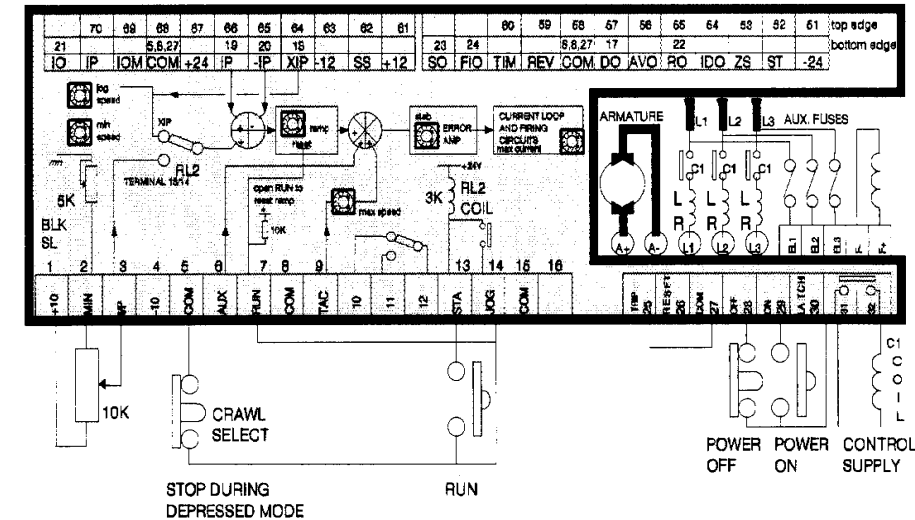

- SL**
- 1) JOGGING WITH MAIN CONTACTOR PERMANENTLY ENERGISED**
 - 2) JOGGING WITH START AND POWER ON FUNCTIONS COMBINED**
 - 3) CRAWL OR RUN SELECT. COASTING DOWN.**
 - 4) JOGGING ON MAIN CONTACTOR**

BARDAC CORP. DOES NOT ACCEPT ANY LIABILITY WHATSOEVER FOR THE INSTALLATION, FITNESS FOR PURPOSE OR APPLICATION OF ITS PRODUCTS. IT IS THE USER'S RESPONSIBILITY TO ENSURE THE UNIT IS CORRECTLY USED AND INSTALLED.

HEALTH AND SAFETY AT WORK. ELECTRICAL DEVICES CONSTITUTE A SAFETY HAZARD. IT IS THE RESPONSIBILITY OF THE USER TO ENSURE COMPLIANCE WITH ANY ACTS OR BYLAWS IN FORCE. ONLY SKILLED PERSONS SHOULD INSTALL THIS EQUIPMENT.

1) THE JOG BUTTON WILL RAMP THE DRIVE DOWN TO STANDSTILL IF MOMENTARILY PRESSED, AND THEN CONTINUE TO JOG AT THE XIP SPEED THROUGH THE DIRECT SPEED INPUT. THIS GIVES RAPID RESPONSE TO THE JOG SPEED REFERENCE. (REMOVE THE ZS JUMPER. THE JOG SPEED preset is 5% maximum in this mode.)

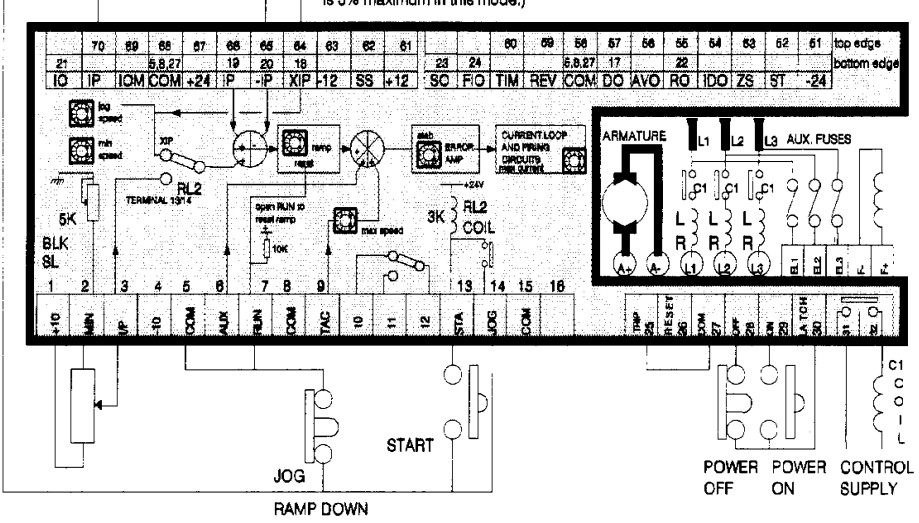

2) CONTACTOR REMAINS ENERGISED DURING JOG. THE POWER ON AND START FUNCTIONS ARE COMBINED. THE JOG SPEED IS SET EXTERNALLY.

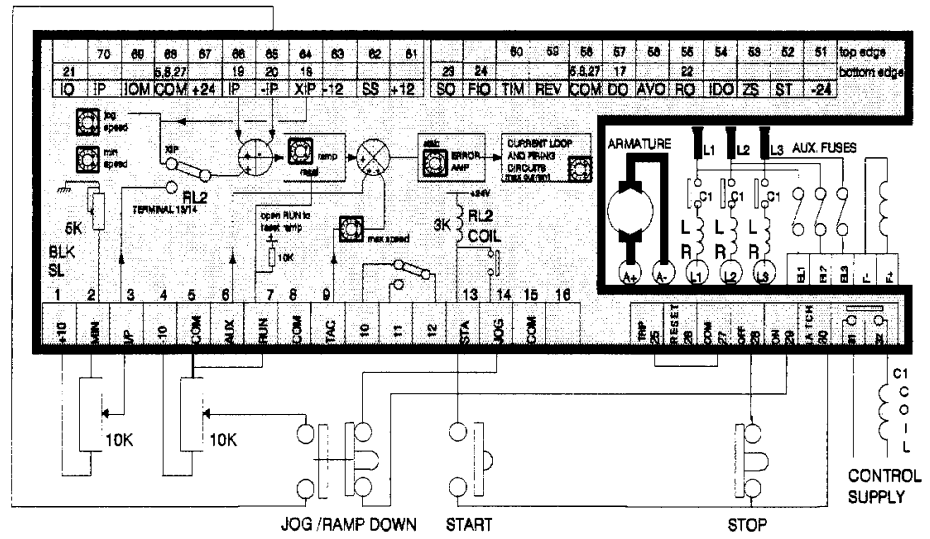

3) CRAWL OR RUN SELECT. RAMP DOWN. (NOTE RAMP DOWN RATE MUST BE SET SLOWER THAN NATURAL COAST DOWN RATE.)

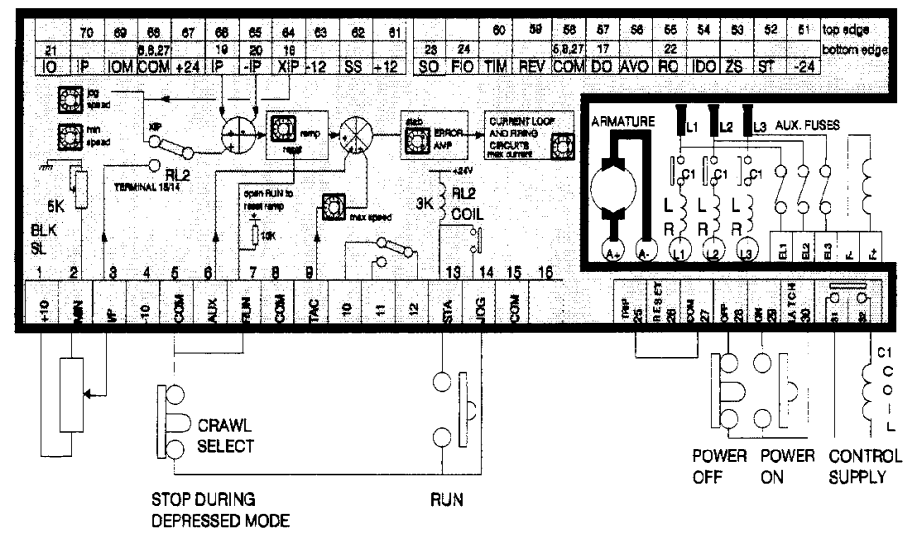

4) JOGGING ON MAIN CONTACTOR WITH ZERO SPEED INTERLOCK FOR JOG FUNCTION (S6 ON, S2/5 OFF).

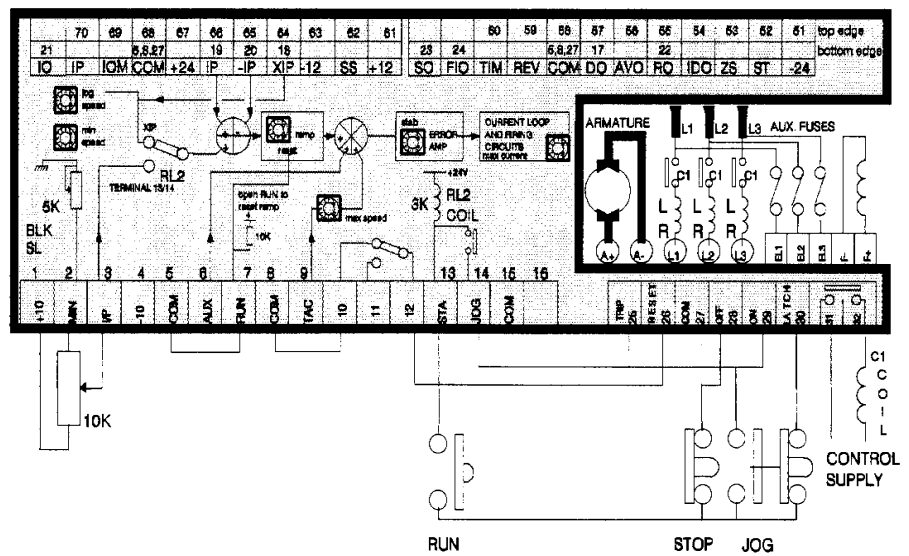

- 1) JOGGING WITH MAIN CONTACTOR ENERGISED VIA DIRECT SPEED INPUT**
- 2) EXTERNAL JOG WITH START AND POWER ON FUNCTIONS COMBINED**
- 3) CRAWL OR RUN SELECT. RAMPING DOWN.**
- 4) JOGGING ON MAIN CONTACTOR WITH ZERO SPEED INTERLOCK**

© 1994 BARDAC CORP. DOES NOT ACCEPT ANY LIABILITY WHATSOEVER FOR THE INSTALLATION, FITNESS FOR PURPOSE OR APPLICATION OF ITS PRODUCTS. IT IS THE USER'S RESPONSIBILITY TO ENSURE THE UNIT IS CORRECTLY USED AND INSTALLED.

HEALTH AND SAFETY AT WORK: ELECTRICAL DEVICES CONSTITUTE A SAFETY HAZARD. IT IS THE RESPONSIBILITY OF THE USER TO ENSURE COMPLIANCE WITH ANY ACTS OR BYLAWS IN FORCE. ONLY SKILLED PERSONS SHOULD INSTALL THIS EQUIPMENT.

MODEL SL SIGNAL PADS

Provision has been made on the MICRO ANALOG PROCESSOR to enable monitoring of some useful signals.

A layout of the MICRO ANALOG PROCESSOR is shown below. (Located on the top edge of the control card).

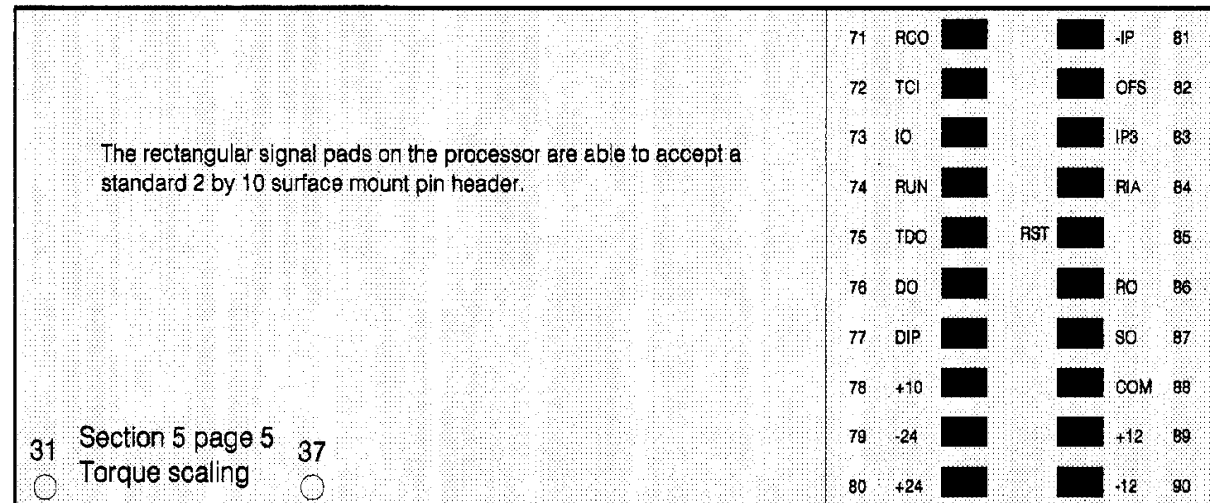

Ramp Control Output. This signal indicates the setpoint ramp status and is -11V when ramping up and 0V when the ramp has finished

Torque Command Input. This signal pad is connected to terminal 6 and shows the level of the auxiliary reference 0 to +/-10V

Field Output. This signal is connected to terminal 24 and shows the magnitude of the Field current. 0 to +5V for 0-100% current.

Run. Shows the status of the RUN signal within the drive. 0 to +11.5V when the RUN terminal 7 is open or main contactor disabled, 0V to run

Torque Demand Output. 0 to +7.5V represents 0 to 150% torque demand (armature current). +5V represents 100%.

Demand Output. 0 to -10V represents 0 to +100% speed demand. This signal is also on terminal 57 and terminal 17.

Direct speed Input. This signal is also on terminal 70, and terminal 6 if the drive is in speed mode. 0 to +10V represents 0 to 100% speed.

+10V. ultra stable speed reference voltage. Also on terminal 1. Absolute value 10V +/-5%. Output capability 10mA maximum.

-24V. Unregulated -24V power supply. May vary between -18V and -35V depending on unit supply voltage and loading. 25mA max, T51

+24V. Unregulated +24V power supply. May vary between +18V and +35V depending on unit supply voltage and loading. 25mA max. T67

71	RCO			-IP	81
72	TCI			OFS	82
73	IO			IP3	83
74	RUN			RIA	84
75	TDO		RST		85
76	DO			RO	86
77	DIP			SO	87
78	+10			COM	88
79	-24			+12	89
80	+24			-12	90

Inverting ramped speed input. Also on T65 and T20. 0 to -10V represents 0 to +100% ramped speed demand. True bi-polar arithmetic summing.

Offset speed input. 0 to +10V represents 0 to -25% speed demand. This input is used for the 4-20mA signal loop offset function.

Input terminal 3. This signal is the main speed demand signal normally input via terminal 3. 0 to +10V for 0 to +100% speed demand.

Ramp Input Auxiliary. Non-inverting speed input also on T66 and T19. 0 to +10V for 0 to +100% speed demand. True bi-polar arithmetic summing.

Ramp sum total. This signal is the summation of all the speed ramp inputs. 0 to +5V represents 0 to +100% speed demand prior to ramping.

Ramp Output. This signal is the ramped version of the signal on 85. 0 to +10V represents 0 to 100% speed demand. It is also on T55 and T22.

AV output. This signal represents the armature voltage signal. Also on terminal 56. 0 to +10V for 0 to +/-500V on the armature terminals.

Common. Electronic 0V

+12V regulated rail. 10mA maximum available. Tolerance 5%.

+12V regulated rail. 10mA maximum available. Tolerance 5%.

- 1) THE JOG BUTTON WILL RAMP THE DRIVE DOWN TO STANDSTILL IF MOMENTARILY PRESSED. THE DRIVE WILL REGENERATE THE BRAKING ENERGY ALLOWING A RAPID DOWN RAMP. THEN CONTINUE TO JOG AT THE XIP SPEED THROUGH THE DIRECT SPEED INPUT. THIS GIVES RAPID RESPONSE TO THE JOG SPEED REFERENCE.**

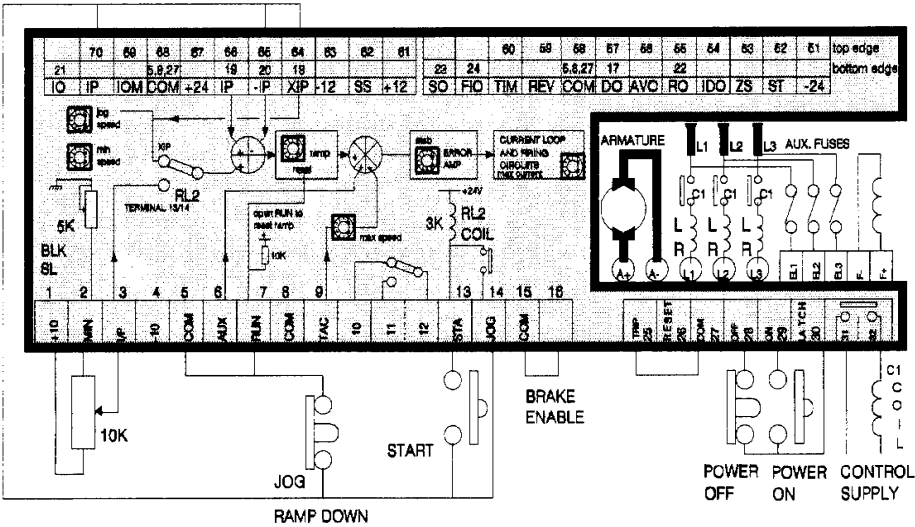

- 2) CONTACTOR REMAINS ENERGISED DURING JOG. THE POWER ON AND START FUNCTIONS ARE COMBINED. THE JOG SPEED IS SET EXTERNALLY. THE RAMP DOWN FUNCTION IS REGENERATIVE ALLOWING RAPID BRAKING.**

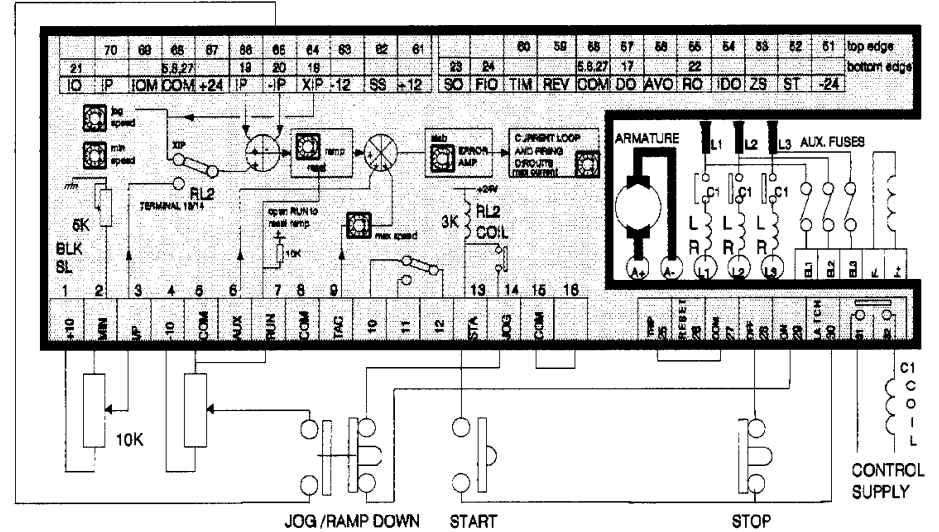

- 3) CRAWL OR RUN SELECT. RAMP DOWN. THE RAMP DOWN FUNCTION IS REGENERATIVE ALLOWING RAPID BRAKING.**

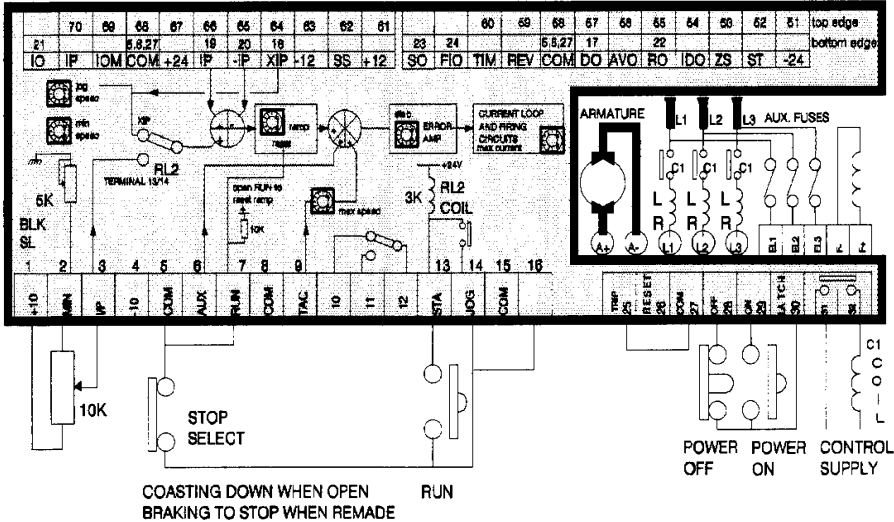

- 4) CRAWL OR RUN SELECT WITH RAMP DOWN. THE RAMP DOWN FUNCTION CAN BE SELECTED TO BE REGENERATIVE ALLOWING RAPID BRAKING, OR NON-REGENERATIVE GIVING COAST DOWN.**

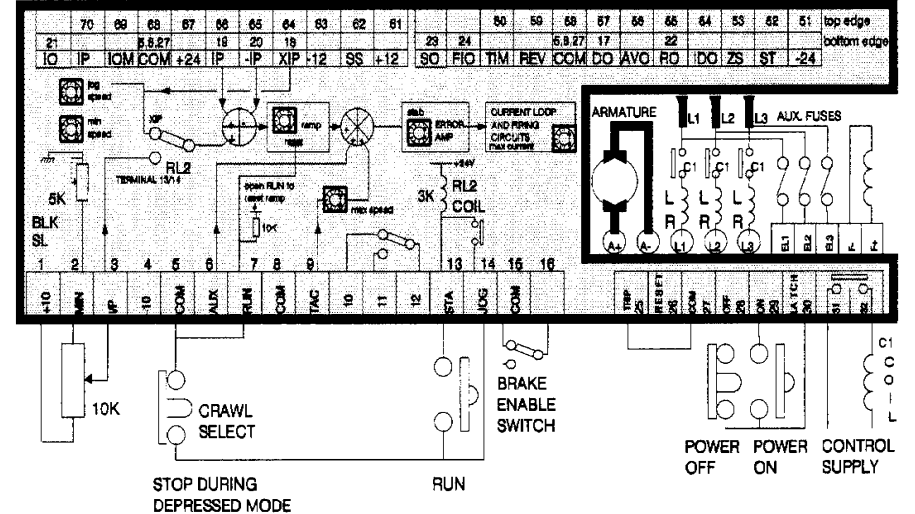

- up to SL50 only**
- 1) JOGGING WITH MAIN CONTACTOR ENERGISED VIA DIRECT SPEED INPUT AND REGENERATIVE BRAKING
 - 2) EXTERNAL JOG WITH START AND POWER ON FUNCTIONS COMBINED AND REGENERATIVE BRAKING
 - 3) COASTING/BRAKING CONTACT
 - 4) CRAWL OR RUN SELECT WITH BRAKE ENABLE SWITCH



1984

BARDAC CORP. DOES NOT ACCEPT ANY LIABILITY WHATSOEVER FOR THE INSTALLATION, FITNESS FOR PURPOSE OR APPLICATION OF ITS PRODUCTS. IT IS THE USER'S RESPONSIBILITY TO ENSURE THE UNIT IS CORRECTLY USED AND INSTALLED.

HEALTH AND SAFETY AT WORK. ELECTRICAL DEVICES CONSTITUTE A SAFETY HAZARD. IT IS THE RESPONSIBILITY OF THE USER TO ENSURE COMPLIANCE WITH ANY ACTS OR BYLAWS IN FORCE. ONLY SKILLED PERSONS SHOULD INSTALL THIS EQUIPMENT.

- 1) THE PROXIMITY DETECTOR WILL RAMP THE DRIVE DOWN TO JOG SPEED WHEN TRIGGERED AND THEN CONTINUE TO CRAWL AT JOG SPEED UNTIL THE RUN CONTACT OPENS. THEN COASTING TO STANDSTILL WILL OCCUR. THE START PUSHBUTTON MUST BE MAINTAINED UNTIL THE LOAD HAS CLEARED THE DETECTOR. (NATURAL COAST DOWN RATE IS LIMIT TO DOWN RAMP)

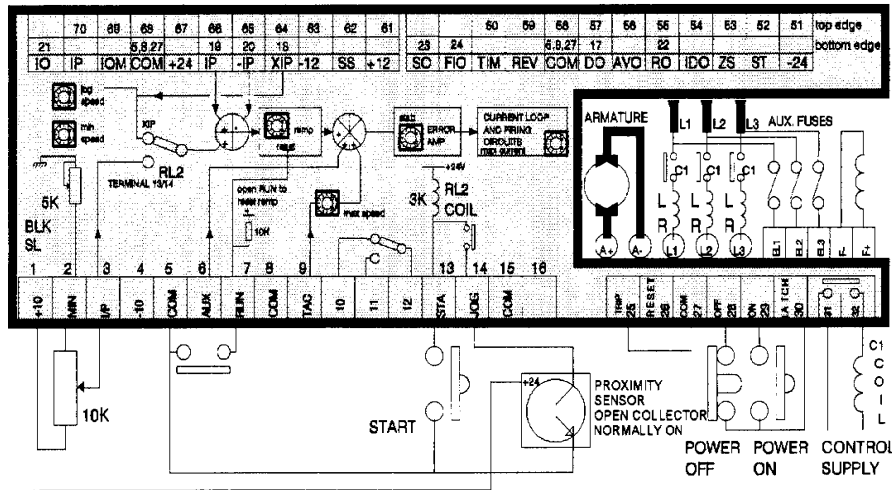

- 2) THE PROXIMITY DETECTOR WILL RAMP/COAST THE DRIVE DOWN TO JOG SPEED WHEN TRIGGERED AND THEN CONTINUE TO CRAWL AT JOG SPEED UNTIL THE END LIMIT SWITCH CONTACT CLOSSES, THEN RAMPING WITH REGENERATION TO STANDSTILL WILL OCCUR. THE START PUSHBUTTON MUST BE MAINTAINED UNTIL THE LOAD HAS CLEARED THE DETECTOR.

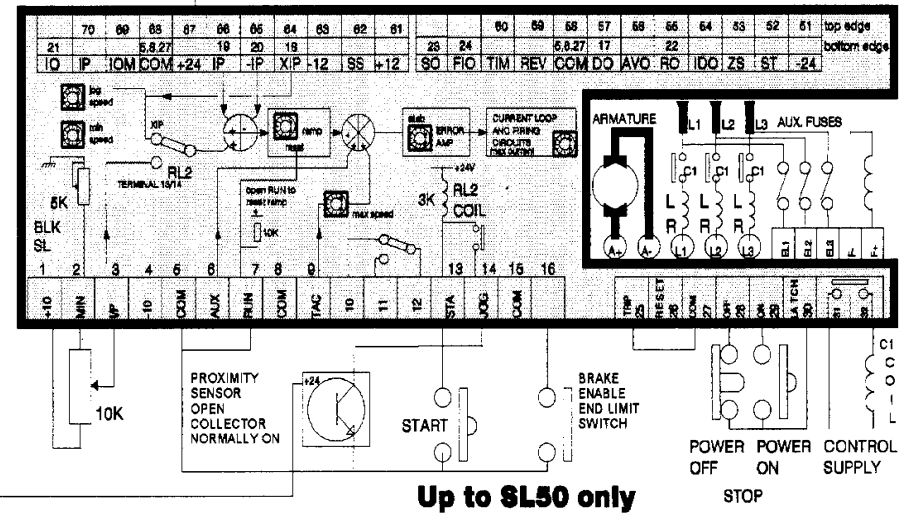

Up to SL50 only

- 3) SIMILAR TO NUMBER 1 BUT THE UNIT REGENERATES TO ZERO AT THE DOWN RAMP RATE WHEN THE SENSOR TRIGGERS. THE JOG SPEED IS SET TO ZERO.

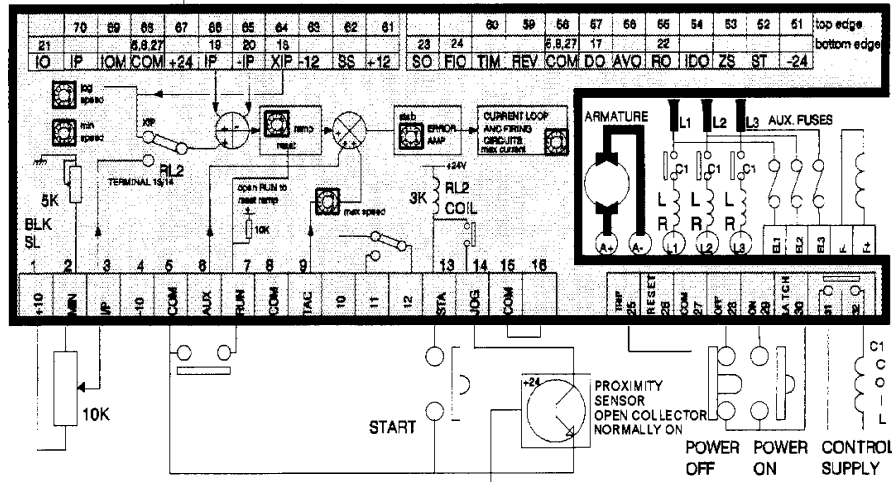

Up to SL50 only

- 4) DROPPING OUT MAIN CONTACTOR WHEN ZERO SPEED IS REACHED. THE ZERO SPEED RELAY OPENS THE LATCH.

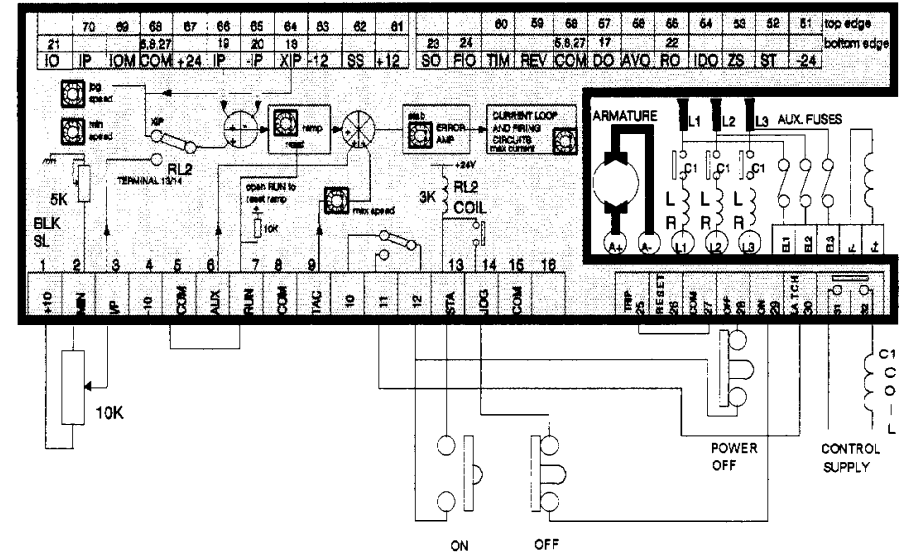

- SL
- 1) RAMPING TO CRAWL TRIGGERED BY PROXIMITY DETECTOR, THEN COASTING TO ZERO
 - 2) RAMPING TO CRAWL AND THEN RAMPING TO ZERO. Up to SL50 only.
 - 3) BRAKING TO ZERO SPEED TRIGGERED BY END LIMIT SWITCH. Up to SL50 only.
 - 4) MAIN CONTACTOR DROP OUT ENABLED BY ZERO SPEED

BARDAC CORP. DOES NOT ACCEPT ANY LIABILITY WHATSOEVER FOR THE INSTALLATION, FITNESS FOR PURPOSE OR APPLICATION OF ITS PRODUCTS. IT IS THE USER'S RESPONSIBILITY TO ENSURE THE USER'S RESPONSIBILITY TO ENSURE THE UNIT IS CORRECTLY USED AND INSTALLED.

HEALTH AND SAFETY AT WORK. ELECTRICAL DEVICES CONSTITUTE A SAFETY HAZARD. IT IS THE RESPONSIBILITY OF THE USER TO ENSURE COMPLIANCE WITH ANY ACTS OR BYLAWS IN FORCE. ONLY SKILLED PERSONS SHOULD INSTALL THIS EQUIPMENT.

TYPICAL APPLICATIONS

**MODEL SL
LOW VOLTAGE AC SUPPLY WITH STEP UP
TRANSFORMER FOR AUXILIARY SUPPLY**

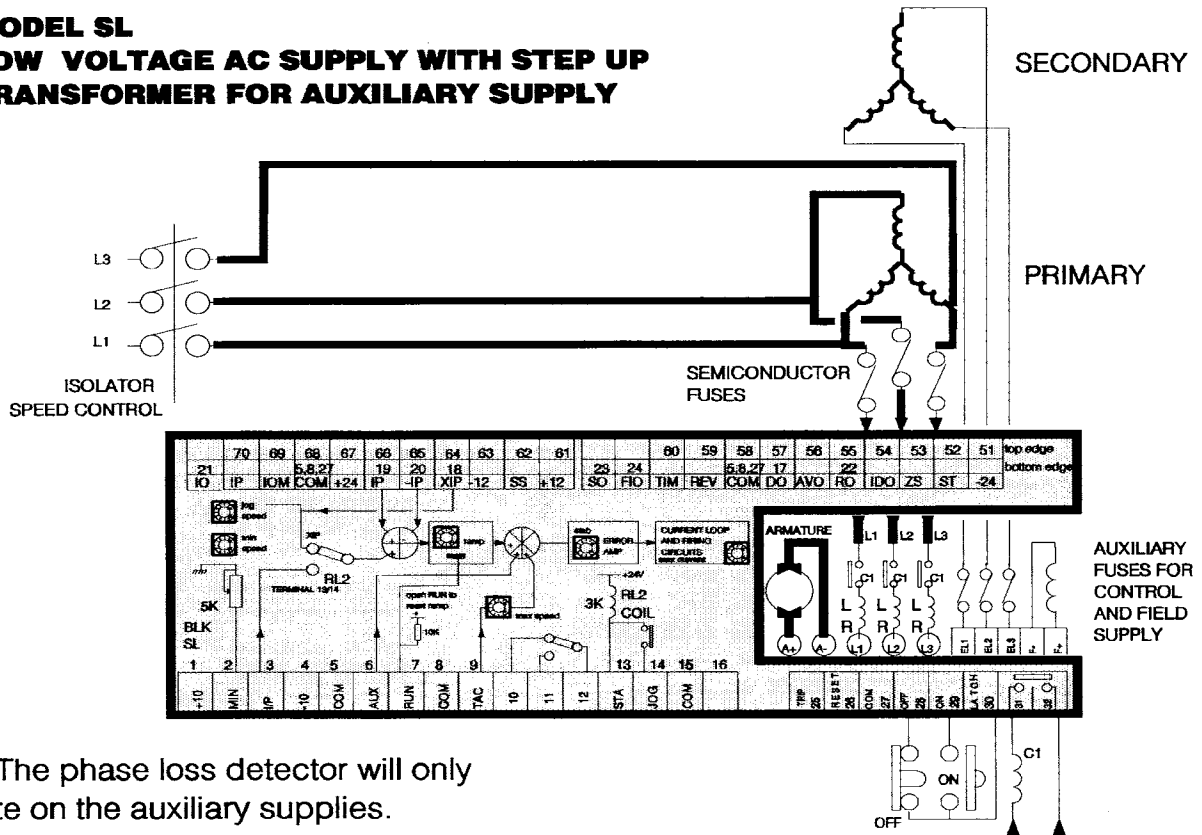

Note. The phase loss detector will only operate on the auxiliary supplies.

**MODEL SL
AC SUPPLY WITH STEP DOWN
TRANSFORMER FOR MAIN SUPPLY**

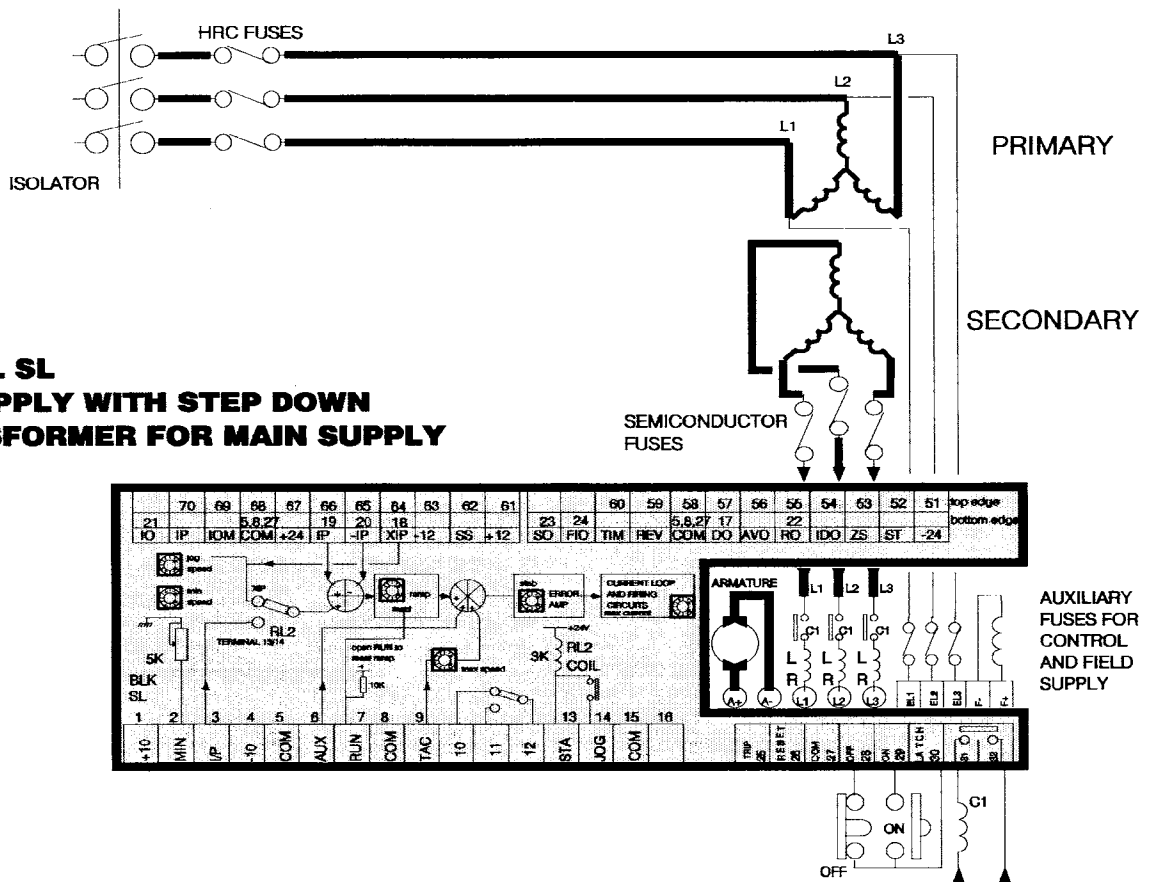

Note. The phase loss detector will only operate on the auxiliary supplies.

BARDAC CORP. DOES NOT ACCEPT ANY LIABILITY WHATSOEVER FOR THE INSTALLATION, FITNESS FOR PURPOSE OR APPLICATION OF ITS PRODUCTS. IT IS THE USER'S RESPONSIBILITY TO ENSURE THE UNIT IS CORRECTLY USED AND INSTALLED.

HEALTH AND SAFETY AT WORK. ELECTRICAL DEVICES CONSTITUTE A SAFETY HAZARD. IT IS THE RESPONSIBILITY OF THE USER TO ENSURE COMPLIANCE WITH ANY ACTS OR BYLAWS IN FORCE. ONLY SKILLED PERSONS SHOULD INSTALL THIS EQUIPMENT.



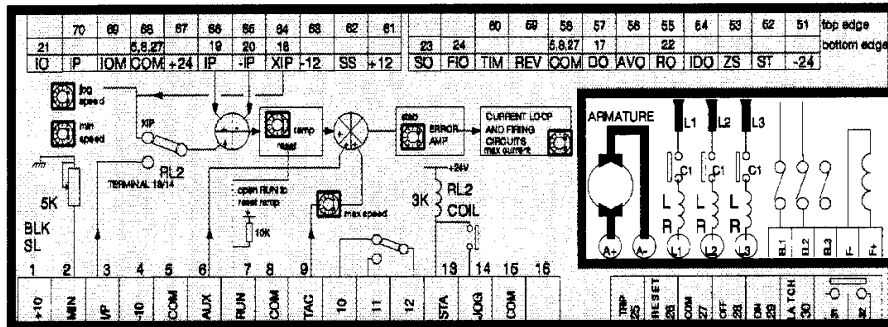
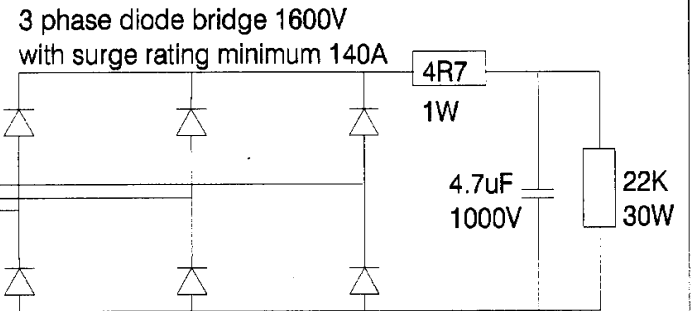
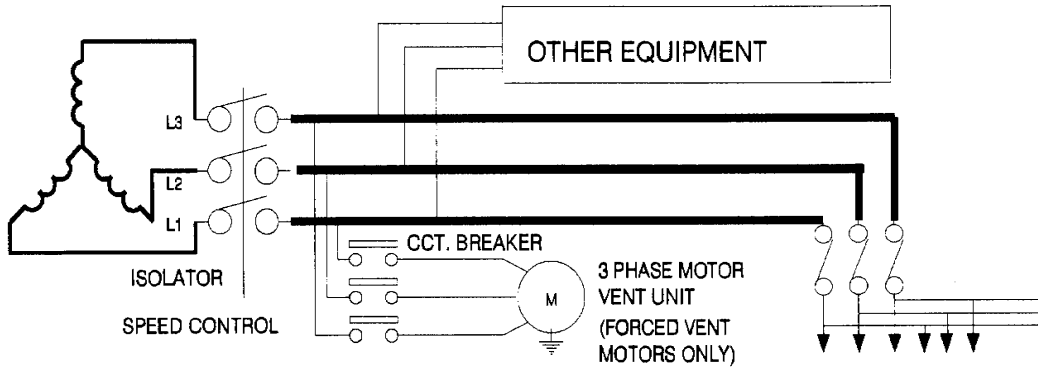

AUXILIARY FUSES FOR CONTROL AND FIELD SUPPLY

When the drive is being supplied from a local transformer, the commutation process in the thyristor bridge will cause high voltage overshoots to occur on the incoming supply. This is due to the inductance of the transformer and the lack of any other substantial load to absorb the high energy spikes.

The high energy spikes may cause damage to other equipment, the drive auxiliary inputs, the blower motor or unwanted thyristor triggering. To prevent this it is necessary to fit a supply conditioning BUCKET circuit to the drive supply.

The BUCKET circuit will soak up the spikes and prevent damage.

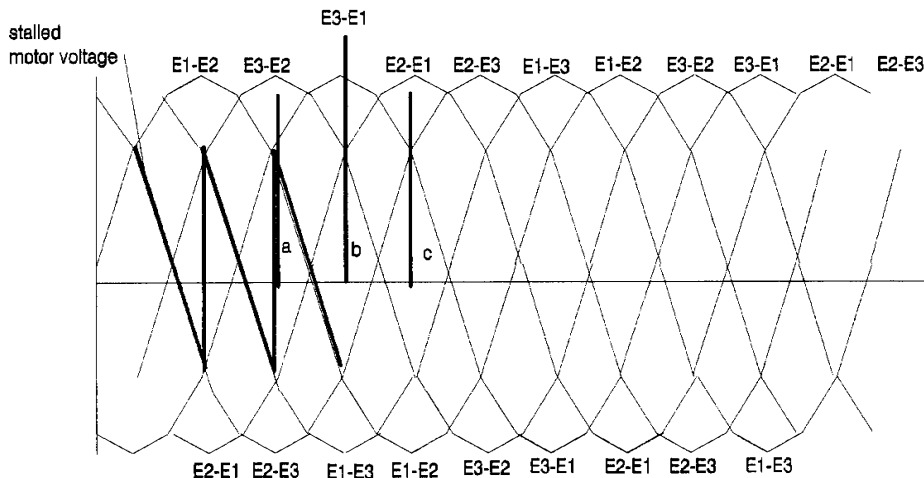

load voltage is zero for duration of commutation because E1-E3 are at zero

commutating from E1-E2 to E3-E2. E3-E1 are shorted due to the commutation process in the armature thyristor bridge.

notch (a) in E3-E1 is caused by E3 being shorted to E2
notch (b) in E3-E1 is caused by E3 being shorted to E1
notch (c) in E3-E1 is caused by E1 being shorted to E2

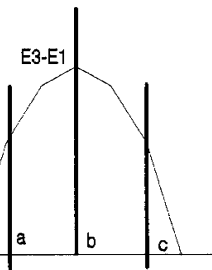

As a general rule a BUCKET circuit will be required with local transformer supplies unless the consumption of current by other non-inductive loads connected to the same transformer exceeds the drive current at any time.

1994

BARDAC CORP. DOES NOT ACCEPT ANY LIABILITY WHATSOEVER FOR THE INSTALLATION, FITNESS FOR PURPOSE OR APPLICATION OF ITS PRODUCTS. IT IS THE USER'S RESPONSIBILITY TO ENSURE THE UNIT IS CORRECTLY USED AND INSTALLED.

HEALTH AND SAFETY AT WORK. ELECTRICAL DEVICES CONSTITUTE A SAFETY HAZARD. IT IS THE RESPONSIBILITY OF THE USER TO ENSURE COMPLIANCE WITH ANY ACTS OR BYLAWS IN FORCE. ONLY SKILLED PERSONS SHOULD INSTALL THIS EQUIPMENT.

Special consideration must be given to installations in member states of the European Union regarding noise suppression and immunity. According to IEC 1800-3 (EN6800-3) the drive units are classified as complex components only for professional assemblers, with no CE marking for EMC. The drive manufacturer is responsible for the provision of installation guidelines. The resulting EMC behaviour is the responsibility of the manufacturer of the system or installation. The units are subject to the LOW VOLTAGE DIRECTIVE 73/23/EEC and are CE marked accordingly. CE

Following the procedures outlined below will normally be required for the drive system to comply with the European regulations, some systems may require different measures. Installers must have a level of technical competence to correctly install. Although the drive unit itself is not subject to the EMC directive, considerable development work has been undertaken to ensure that the noise emissions and immunity are optimised.

***** EN6800-3 specifies 2 alternative operating environments. These are the domestic (1st environment) and industrial (2nd environment). There are no limits specified for conducted or radiated emissions in the industrial environment, hence it is usual for the filter to be omitted in industrial systems.

Definition of an industrial environment. All establishments other than those directly connected to a low-voltage power supply network which supplies buildings used for domestic purposes.

DRIVE INSTALLATION REQUIREMENTS FOR EMC COMPLIANCE

Keep parallel runs of power and control cables at least 0.3m apart. Crossovers must be at right angles

Keep sensitive components at least 0.3m from the drive and power supply cables

The AC connections from the filter to the drive must be less than 0.3m or if longer correctly screened

Do not run filtered and unfiltered AC supply cables together

Control signals must be filtered or suppressed eg control relay coils and current carrying contacts. The drive module has built in filters on signal outputs

The AC supply filter must have a good earth connection to the enclosure back plane. Take care with painted metal to ensure good conductivity.

The AC input filter has earth leakage currents. Earth RCD devices may need to be set at 5% of rated current

The metal enclosure will be the RF ground. The AC filter, drive earth and motor cable screen should connect directly to the metal of the cabinet for best performance

Linear control signal cables must be screened with the screen earthed at the drive end only. Minimise the length of screen stripped back and connect it to an analogue earth point

The motor cable must be screened or armoured with 360 degree screen terminations to earth at each end. The cable must have an internal earth cable and the screen must extend into the enclosure and motor terminal box to form a Faraday cage without gaps

The internal earth cable must be earthed at each end. The incoming earth must be effective at RF. **WARNING!** the earth safety must always take precedence.

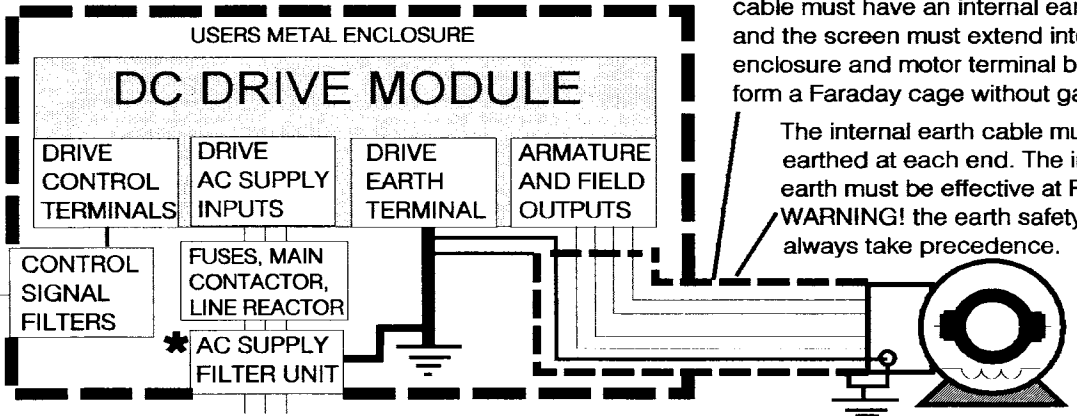

IMPORTANT SAFETY WARNINGS



The AC supply filters must not be used on supplies that are un-balanced or float with respect to earth

The drive and AC filter must only be used with a permanent earth connection. No plugs/sockets are allowed in the AC supply

The AC supply filter contains high voltage capacitors and should not be touched for a period of 20 seconds after the removal of the AC supply

MULTIPLE DRIVES WITH ONE FILTER AND EARTHING METHODS

The drive units are designed to function normally on unfiltered AC supplies shared with other thyristor DC drives. (not AC drives). The filter is rated for total load.

3 PHASE AC FROM MAIN FILTER UNIT

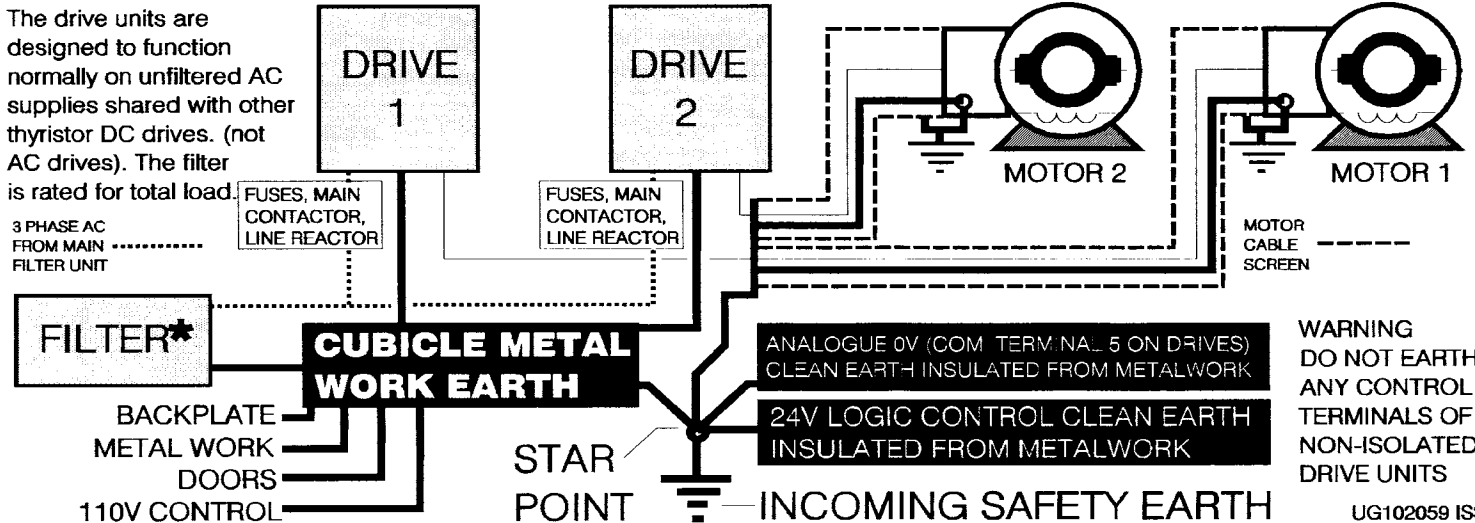

WARNING
DO NOT EARTH ANY CONTROL TERMINALS OF NON-ISOLATED DRIVE UNITS

INDEX

- Alarm defeat 3.1
- Alarm reset 3.1
- Alarms 3.1
- Alternate supply volts 2.4
- Altitude 1.2
- Analogue processing 2.5
- Applying power 2.4
- Arm volts/tach 2.2
- Armature volts 1.2
- Armature voltage limit 2.2 2.7
- Assembly 3.18
- Automatic field weakening 3.9
- Auxiliary supply phasing 2.1
- Auxiliary trip 3.1

- Block Diagram 1.6
- Block diagram Inhibit cct. 3.3
- Braking 3.3 3.6

- Contact ratings 1.2 1.3
- Cooling air 3.13 3.15 3.16
- Current loop signal 4-20mA 2.3
- Current response 2.8
- Current stability 2.8
- Customer presets 1.5 3.8 3.9

- Derivative term 2.8 3.8
- Disable contactor 2.1 2.4
- Dynamic braking 4.1/5.1
- Dynamic indicators 3.2

- External alarm lamps 3.9
- Fan 3.13 3.15 3.16
- Fault finding chart 3.10 3.11 1.8
- Feedback volts 2.2 3.12
- Field adjustment 3.8 3.9
- Field control 3.8 3.9
- Field loss 3.1
- Field output volts 1.2 3.8 3.9
- Field regulation region 3.2 3.8
- Field regulation 3.2 3.8 3.9
- Field set up 3.8 3.9
- Field voltage display 3.2 3.8 3.9
- Fixing slots 3.15 3.16
- Function switches 2.2
- Fuses 3.14 3.13
- Fusing and earthing 1.7

- General description 1.1

- Increased overload facility 3.7
- Initial presets 2.1
- Input fuse rating 3.14
- Installation checking 2.1
- Interface connector 3.9
- Inverted total setpoint 1.3 1.4 2.3

- Jumper functions 2.3
- Jumpers 2.3 1.5 3.8 3.9

- Lamps +/- 3.2
- Latched indicators 3.2
- Line reactor 1.7 3.13 3.17
- Links 2.3 1.5 3.8 3.9
- List of contents 1.1
- Log of presets 1.5 3.8 3.9
- Long ramp 3.4
- Low speed check 2.7

- Main contactor 1.7 4.7/5.7
- Main contactor disable 2.1 2.4
- Main contactor slave 1.3 2.6
- Maintenance 3.18
- Max current graphs 3.5
- Max current preset mode 3.6
- Max field lamp 3.2
- Max speed 2.2 2.7 3.12
- Maximum field amps 3.13
- Maximum amps 3.13
- Mechanical outline 3.13 3.14
- Min field lamp 3.13
- Min speed 1.5 2.3 2.7
- Motor direction 2.7
- Motor inspection 2.1
- Motor power 1.2 3.13

- Option links 2.3
- Overload capacity 3.7
- Overshoot 2.8

- Peak amps 3.1
- Phase rotation 2.1
- Power board assembly 3.18
- Power on/off 1.7 5.7
- Power on Inhibit 3.3
- Preset controls 1.2 1.5 3.8 3.9
- Preset pots 1.5 3.8 3.9
- Preset switches 1.5 2.2
- Pushbutton inputs 1.2 1.7
4/5.11 4/5.12

- Quadrant diagram 3.6
- Quench condition 3.3

- Rails and drivers 1.4
- Rarmps 2.3 3.4
- Rating table 3.13
- Ratings 1.2 3.13 3.14
- Reference 2.5
- Regenerative braking 3.3 3.6
- Relative humidity 1.2
- Relay 1 function 2.2
- Relay 2 function 3.3
- Run line 1.7 3.3 3.4

- S ramp 2.3
- Safety (inside front cover)
- Set up procedure 2.1
- Setpoint checking 2.5
- Setpoint ramp graphs 3.4
- Signal outputs 1.3 1.4
- Slave contact 1.3 2.6
- Small perturbation 2.8
- Spares 3.18
- Speed demand 2.5
- Speed error loop 2.6
- Speed jumper 1.5 2.3
- Speed range 1.5 2.2
- Speed response 2.8
- Speed stability 2.8
- Stability 2.8
- Stall 3.7
- Stall detector 3.7
- Stall integrator 3.7
- Stall lamp 3.1
- Stall threshold 50% 3.7
- Stall timer description 3.7
- Start 1.3 1.7 2.4 3.3
- Steady state accuracy 1.2
- Stopping mode graphs 3.3 3.4
- Supply voltage 1.2 2.4
- Suppressor 2.6
- Switch functions 1.2 1.5 2.2

- Tach/arm volts 2.2 3.1 3.12
- Tacho feedback 2.2 2.7 3.9
- Tacho loss 3.1
- Temperature 1.2 3.1
- Terminal 6. 1.3 3.6
- Terminal description 1.3 1.4
- Terminal listing 1.3 1.4
- Thermistor 3.1
- Timer 3.7
- Timer lamp 3.2 3.7
- Torque/speed jumper 2.3
- Torque control 3.5
- Torque demand 2.6 3.6 3.7
- Torque function graphs 3.5
- Torque jumper 1.5 2.3 2.6 3.6
- Torque limit 3.5
- Typical Wiring 1.7 4.XX/5.XX

- Warning (Onside front cover)
- Worked example speed scaling 3.12

- Zero detector 2.2 2.3 3.3
- Zero speed 2.7
- Zero speed jumper 1.5 2.7
- ZS quench 2.3

WORLD CLASS IN DESIGN

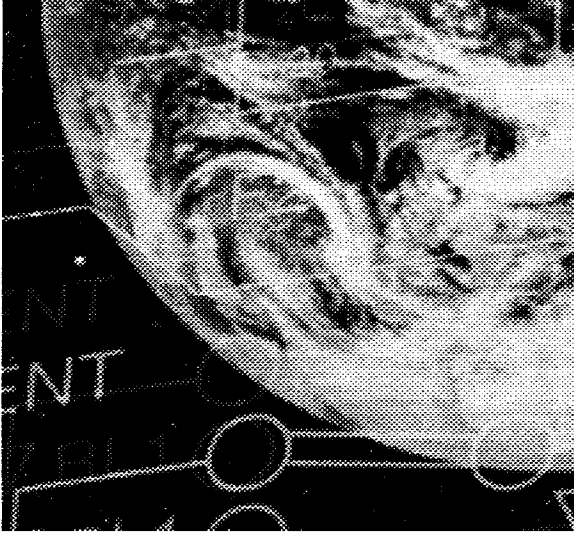

WORLD BEATING IN FUNCTION

Sprint Electric Limited
Arundel BN18 0BD
UK
info@sprint-electric.com
www.sprint-electric.com