



## INVERTER

# FR-S500

## INSTRUCTION MANUAL (BASIC)

FR-S520E-0.1K to 3.7K(-C)

FR-S540E-0.4K to 3.7K

FR-S520SE-0.1K to 1.5K

FR-S510WE-0.1K to 0.75K

Thank you for choosing this Mitsubishi inverter.

If this is the first time for you to use the FR-S500 series, please read through this instruction manual (basic) carefully and use the inverter safely.

If you are going to use the inverter for higher-level applications, the FR-S500 instruction manual (detailed) [IB(NA)-0600152E] is separately available from where you purchased the inverter or a Mitsubishi sales representative.

### CONTENTS

<b>1</b>	<b>CONNECTION OF PERIPHERAL DEVICES</b> .....	<b>3</b>
	1.1 Basic configuration .....	3
<b>2</b>	<b>INSTALLATION METHOD</b> .....	<b>6</b>
	2.1 Installation of the inverter .....	6
<b>3</b>	<b>SPECIFICATIONS OF WIRING AND TERMINALS</b> .....	<b>7</b>
	3.1 Terminal connection diagram .....	7
	3.2 Main circuit .....	8
	3.3 Control circuit .....	12
<b>4</b>	<b>RUN AND OPERATION</b> .....	<b>17</b>
	4.1 Setting the frequency to perform operation (example: performing operation at 30Hz) .....	19
	4.2 Using the setting dial like a potentiometer to perform operation .....	20
	4.3 Setting the parameters .....	21
	4.4 Clearing the parameters .....	23
	4.5 Monitoring the output current .....	24
	4.6 Adjusting the current amount for frequency setting signal (example: performing operation at 30Hz) .....	25
<b>5</b>	<b>ADJUSTMENT OF THE FREQUENCY SETTING POTENTIOMETER AND INDICATOR</b> .....	<b>27</b>
	5.1 Changing the output frequency setting of the frequency setting potentiometer (bias and gain of frequency setting voltage (current)) .....	28
	5.2 Adjustment (calibration) of the frequency meter (indicator) .....	31
<b>6</b>	<b>FUNCTION LIST</b> .....	<b>32</b>
	6.1 Basic function parameter list .....	32
	6.2 Explanation of the basic function parameters .....	33
	6.3 Extended function parameter list .....	35
<b>7</b>	<b>ERRORS AND PROTECTIVE FUNCTIONS</b> .....	<b>49</b>
	7.1 About errors (definitions) .....	49
	7.2 To know the operating status at the occurrence of alarm (only when FR-PU04 is used) .....	52
	7.3 Correspondence between digital and actual characters .....	52
	7.4 Resetting the inverter .....	52
	7.5 Troubleshooting .....	53
	7.6 Precautions for maintenance and inspection .....	56
<b>8</b>	<b>SPECIFICATIONS</b> .....	<b>67</b>
	8.1 Ratings .....	67
	8.2 Common specifications .....	71
<b>9</b>	<b>OUTLINE DRAWINGS</b> .....	<b>73</b>
	Appendix 1 Instructions for compliance with the European Directive .....	76
	Appendix 2 Instructions for UL and cUL .....	78

1

2

3

4

5

6

7

8

9

This instruction manual (basic) provides handling information and precautions for use of the equipment.

Please forward this instruction manual (basic) to the end user.

## This section is specifically about safety matters

Do not attempt to install, operate, maintain or inspect the inverter until you have read through this instruction manual (basic) and appended documents carefully and can use the equipment correctly. Do not use the inverter until you have a full knowledge of the equipment, safety information and instructions.

In this instruction manual (basic), the safety instruction levels are classified into "WARNING" and "CAUTION".



### WARNING

Assumes that incorrect handling may cause hazardous conditions, resulting in death or severe injury.



### CAUTION

Assumes that incorrect handling may cause hazardous conditions, resulting in medium or slight injury, or may cause physical damage only.

Note that even the  **CAUTION** level may lead to a serious consequence according to conditions. Please follow the instructions of both levels because they are important to personnel safety.

## 1. Electric Shock Prevention



### WARNING

- While power is on or when the inverter is running, do not open the front cover. You may get an electric shock.
- Do not run the inverter with the front cover or wiring cover removed. Otherwise, you may access the exposed high-voltage terminals or the charging part of the circuitry and get an electric shock. Also, the inverter's ability to withstand earthquakes will deteriorate.
- Even if power is off, do not remove the front cover except for wiring or periodic inspection. You may access the charged inverter circuits and get an electric shock.
- Before starting wiring or inspection, check to make sure that the 3-digit LED inverter monitor is off, wait for at least 10 minutes after the power supply has been switched off, and check to make sure that there are no residual voltage using a tester or the like.
- This inverter must be earthed (grounded). Earthing (grounding) must conform to the requirements of national and local safety regulations and electrical codes. (JIS, NEC section 250, IEC 536 class 1 and other applicable standards)
- Any person who is involved in the wiring or inspection of this equipment should be fully competent to do the work.
- Always install the inverter before wiring. Otherwise, you may get an electric shock or be injured.
- Perform setting dial and key operations with dry hands to prevent an electric shock.
- Do not subject the cables to scratches, excessive stress, heavy loads or pinching. Otherwise, you may get an electric shock.
- Do not change the cooling fan while power is on. It is dangerous to change the cooling fan while power is on.
- When you have removed the front cover, do not touch the connector above the 3-digit monitor LED display. Otherwise, you get an electric shock.

## 2. Fire Prevention

### CAUTION

- Mount the inverter and brake resistor on an incombustible surface. Installing the inverter and brake resistor directly on or near a combustible surface could lead to a fire.
- If the inverter has become faulty, switch off the inverter power. A continuous flow of large current could cause a fire.
- When using a brake resistor, make up a sequence that will turn off power when an alarm signal is output. Otherwise, the brake resistor may excessively overheat due to damage of the brake transistor and such, causing a fire.
- Do not connect a resistor directly to the DC terminals P, N. This could cause a fire.

## 3. Injury Prevention

### CAUTION

- Apply only the voltage specified in the instruction manual to each terminal to prevent damage, etc.
- Always connect to the correct terminal to prevent damage, etc.
- Always make sure that polarity is correct to prevent damage, etc.
- While power is on or for some time after power-off, do not touch the inverter as it is hot and you may get burnt.

## 4. Additional Instructions

Also note the following points to prevent an accidental failure, injury, electric shock, etc.

### (1) Transportation and installation

### CAUTION

- When carrying products, use correct lifting gear to prevent injury.
- Do not stack the inverter boxes higher than the number recommended.
- Ensure that installation position and material can withstand the weight of the inverter. Install according to the information in the instruction manual.
- Do not operate if the inverter is damaged or has parts missing.
- When carrying the inverter, do not hold it by the front cover or setting dial; it may fall off or fail.
- Do not stand or rest heavy objects on the inverter.
- Check the inverter mounting orientation is correct.
- Prevent screws, wire fragments, other conductive bodies, oil or other flammable substances from entering the inverter.
- As the inverter is a precision instrument, do not drop or subject it to impact.
- Use the inverter under the following environmental conditions: This could cause the inverter damage.

Environment	Ambient Temperature	-10°C to +50°C (non-freezing) (-10°C to +40°C for totally enclosed structure feature)
	Ambient humidity	90%RH maximum (non-condensing)
	Storage temperature	-20°C to +65°C *
	Atmosphere	Indoors (free from corrosive gas, flammable gas, oil mist, dust and dirt)
	Altitude/vibration	Max.1000m above sea level 5.9m/s <sup>2</sup> or less (conforming to JIS C 0040)

\*Temperatures applicable for a short time, e.g. in transit.

## (2) Wiring

### CAUTION

- Do not fit capacitive equipment such as power factor correction capacitor, radio noise filter (option FR-BIF(-H)) or surge suppressor to the output of the inverter.
- The connection orientation of the output cables U, V, W to the motor will affect the direction of rotation of the motor.

## (3) Trial run

### CAUTION

- Check all parameters, and ensure that the machine will not be damaged by a sudden start-up.
- When the load  $GD^2$  is small (at the motor  $GD$  or smaller) for 400V from 1.5K to 3.7K, the output current may vary when the output frequency is in the 20Hz to 30Hz range. If this is a problem, set the Pr.72 "PWM frequency selection" to 6kHz or higher. (When setting the PWM to a higher frequency, check for noise or leakage current problem and take countermeasures against it.)

## (4) Operation

### WARNING

- When you have chosen the retry function, stay away from the equipment as it will restart suddenly after an alarm stop.
- The [STOP] key is valid only when the appropriate function setting has been made. Prepare an emergency stop switch separately.
- Make sure that the start signal is off before resetting the inverter alarm. A failure to do so may restart the motor suddenly.
- The load used should be a three-phase induction motor only. Connection of any other electrical equipment to the inverter output may damage the equipment.
- Do not modify the equipment.
- Do not perform parts removal which is not instructed in this manual. Doing so may lead to fault or damage of the inverter.

## CAUTION

- The electronic thermal relay function does not guarantee protection of the motor from overheating.
- Do not use a magnetic contactor on the inverter input for frequent starting/stopping of the inverter.
- Use a noise filter to reduce the effect of electromagnetic interference. Otherwise nearby electronic equipment may be affected.
- Take measures to suppress harmonics. Otherwise power supply harmonics from the inverter may heat/damage the power capacitor and generator.
- When a 400V class motor is inverter-driven, please use an insulation-enhanced motor or suppress surge voltages. Surge voltages attributable to the wiring constants may occur at the motor terminals, deteriorating the insulation of the motor.
- When parameter clear or all clear is performed, each parameter returns to the factory setting. Re-set the required parameters before starting operation.
- The inverter can be easily set for high-speed operation. Before changing its setting, fully examine the performances of the motor and machine.
- In addition to the inverter's holding function, install a holding device to ensure safety.
- Before running an inverter which had been stored for a long period, always perform inspection and test operation.

### **(5) Emergency stop**

## CAUTION

- Provide a safety backup such as an emergency brake which will prevent the machine and equipment from hazardous conditions if the inverter fails.
- When the breaker on the inverter primary side trips, check for the wiring fault (short circuit), damage to internal parts of the inverter, etc. Identify the cause of the trip, then remove the cause and power on the breaker.
- When any protective function is activated, take the appropriate corrective action, then reset the inverter, and resume operation.

### **(6) Maintenance, inspection and parts replacement**

## CAUTION

- Do not carry out a megger (insulation resistance) test on the control circuit of the inverter.

### **(7) Disposing of the inverter**

## CAUTION

- Treat as industrial waste.

### **(8) General instructions**

Many of the diagrams and drawings in this instruction manual (basic) show the inverter without a cover, or partially open. Never operate the inverter in this manner. Always replace the cover and follow this instruction manual (basic) when operating the inverter.

## Harmonic Suppression Guideline

All models of inverters used by specific consumers are covered by "Harmonic suppression guideline for consumers receiving high voltage or special high voltage". (For details, refer to the Instruction Manual (detailed).)

## Product Checking and Parts Identification

Unpack the inverter and check the capacity plate on the front cover and the rating plate on the inverter side face to ensure that the product agrees with your order and the inverter is intact.

- Parts and name plate

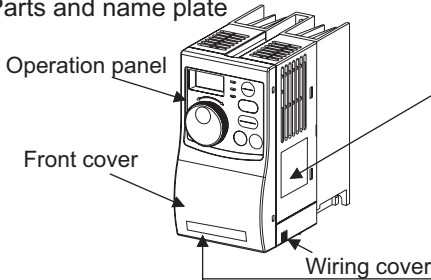

Rating plate	
Inverter type	MITSUBISHI INVERTER
Input rating	MODEL → FR-S520E-0.1K
Output rating	INPUT : XXXXX
Serial number	OUTPUT : XXXXX
	SERIAL : _____
	PASSED

Capacity plate	FR-S520E-0.1K	XXXXXX
	↑	↑
	Inverter type	Serial number

- Inverter type

FR - **S520E** - **0.1** K -

Symbol	Voltage class
S520E	Three-phase 200V class
S540E	Three-phase 400V class
S520SE	Single-phase 200V class
S510WE	Single-phase 100V class

Inverter capacity "kW"

Symbol	Structure, terminal symbol, etc.
None	Enclosed type
C	Totally enclosed structure IP40

● **Removal and reinstallation of the front cover**

Remove the front cover by pulling it toward you in the direction of arrow.  
To reinstall, match the cover to the inverter front and install it straight.



FR-S520E-0.1K to 0.75K

FR-S520E-1.5K to 3.7K

FR-S520SE-0.1K to 0.75K

FR-S520SE-1.5K

FR-S510WE-0.1K to 0.4K

FR-S540E-0.4K to 3.7K

FR-S510WE-0.75K

● **Removal and reinstallation of the wiring cover**

The cover can be removed easily by pulling it toward you.

To reinstall, fit the cover to the inverter along the guides.

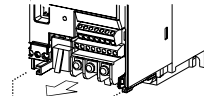

Wiring cover

● **RS-485 communication connector**

When using the RS-485 connector to wire the cable, you can cut off the tab of the wiring cover to wire it. (Cutting off the tab will provide protective structure IP10.)

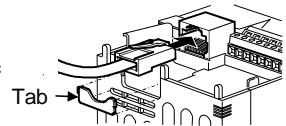

**CAUTION**

The connector above the operation panel is for manufacturer use. Do not touch it as doing so may cause an electric shock.

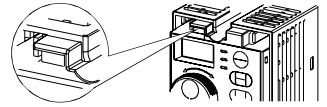

# 1. CONNECTION OF PERIPHERAL DEVICES

## 1.1 Basic configuration

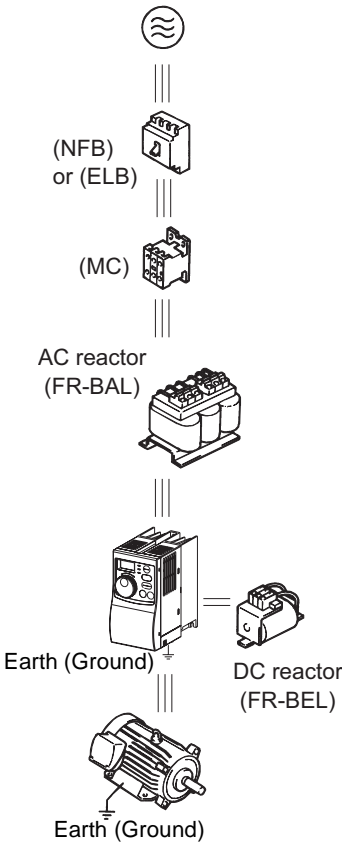

### **Power supply**

Use within the permissible power supply specifications of the inverter. (Refer to page 67.)

### **No-fuse breaker or earth leakage circuit breaker**

The breaker must be selected carefully since an inrush current flows in the inverter at power on.

### **Magnetic contactor**

Install for your safety. Do not use this magnetic contactor to start and stop the inverter. Doing so will cause the inverter life to be shortened. (Refer to page 16.)

### **Installation of a reactor**

A reactor must be used when the power factor is to be improved or the inverter is installed near a large supply system (500kVA or more and wiring distance within 10 m).

Make the selection carefully.

Inverter
The life of the inverter is influenced by ambient temperature. Check the ambient temperature. Especially when mounting the inverter inside an enclosure, take cautions of the ambient temperature. (Refer to page 72.)
Wrong wiring might lead to damage of the inverter. The control signal wires must be kept fully away from the main circuit to protect them from noise. (Refer to page 7.)

### **Devices connected to the output**

Do not install a power factor correction capacitor, surge suppressor or radio noise filter on the output side of the inverter.

When installing a no-fuse breaker on the output side of the inverter, contact each manufacturer for selection of the no-fuse breaker.

### **Earth (Ground)**

To prevent an electric shock, always earth (ground) the motor and inverter.

For reduction of induction noise from the power line of the inverter, it is recommended to wire the earth (ground) cable by returning it to the earth (ground) terminal of the inverter.

(For details of noise reduction techniques, refer to the instruction manual (detailed).)



**Selection of peripheral devices (selection changes with the power input specifications of the inverter)**

●FR-S520E-0.1K to 3.7K(-C)

Motor Output (kW)	Applicable Inverter Type	No-fuse Breaker (NFB *1, 4) or Earth Leakage Circuit Breaker (ELB) (*2, 4)	Magnetic Contactor (MC) (Refer to page 16)	Power Factor Improving AC Reactor	Power Factor Improving DC Reactor
0.1	FR-S520E-0.1K(-C)	30AF/5A	S-N10	FR-BAL-0.4K (*3)	FR-BEL-0.4K (*3)
0.2	FR-S520E-0.2K(-C)	30AF/5A	S-N10	FR-BAL-0.4K (*3)	FR-BEL-0.4K (*3)
0.4	FR-S520E-0.4K(-C)	30AF/5A	S-N10	FR-BAL-0.4K	FR-BEL-0.4K
0.75	FR-S520E-0.75K(-C)	30AF/10A	S-N10	FR-BAL-0.75K	FR-BEL-0.75K
1.5	FR-S520E-1.5K(-C)	30AF/15A	S-N10	FR-BAL-1.5K	FR-BEL-1.5K
2.2	FR-S520E-2.2K(-C)	30AF/20A	S-N10	FR-BAL-2.2K	FR-BEL-2.2K
3.7	FR-S520E-3.7K(-C)	30AF/30A	S-N20, S-N21	FR-BAL-3.7K	FR-BEL-3.7K

●FR-S540E-0.4K to 3.7K

Motor Output (kW)	Inverter Type	No-fuse Breaker (NFB *1, 4) or Earth Leakage Circuit Breaker (ELB) (*2, 4)	Magnetic Contactor (MC) (Refer to page 16)	Power Factor Improving AC Reactor	Power Factor Improving DC Reactor
0.4	FR-S540E-0.4K	30AF/5A	S-N10	FR-BAL-H0.4K	FR-BEL-H0.4K
0.75	FR-S540E-0.75K	30AF/5A	S-N10	FR-BAL-H0.75K	FR-BEL-H0.75K
1.5	FR-S540E-1.5K	30AF/10A	S-N10	FR-BAL-H1.5K	FR-BEL-H1.5K
2.2	FR-S540E-2.2K	30AF/15A	S-N10	FR-BAL-H2.2K	FR-BEL-H2.2K
3.7	FR-S540E-3.7K	30AF/20A	S-N20, S-N21	FR-BAL-H3.7K	FR-BEL-H3.7K

## ● FR-S520SE-0.1K to 1.5K

Motor Output (kW )	Inverter Type	No-fuse Breaker (NFB *1, 4) or Earth Leakage Circuit Breaker (ELB) (*2, 4)	Magnetic Contactor (MC) (Refer to page 16)	Power Factor Improving AC Reactor (*3)	Power Factor Improving DC Reactor (*3)
0.1	FR-S520SE-0.1K	30AF/5A	S-N10	FR-BAL-0.4K	FR-BEL-0.4K
0.2	FR-S520SE-0.2K	30AF/10A	S-N10	FR-BAL-0.4K	FR-BEL-0.4K
0.4	FR-S520SE-0.4K	30AF/10A	S-N20, S-N21	FR-BAL-0.75K	FR-BEL-0.75K
0.75	FR-S520SE-0.75K	30AF/15A	S-N20, S-N21	FR-BAL-1.5K	FR-BEL-1.5K
1.5	FR-S520SE-1.5K	30AF/20A	S-N20, S-N21	FR-BAL-2.2K	FR-BEL-2.2K

## ● FR-S510WE-0.1K to 0.75K

Motor Output (kW )	Inverter Type	No-fuse Breaker (NFB *1, 4) or Earth Leakage Circuit Breaker (ELB) (*2, 4)	Magnetic Contactor (MC) (Refer to page 16)	Power Factor Improving AC Reactor (*3)	Power Factor Improving DC Reactor (*5)
0.1	FR-S510WE-0.1K	30AF/10A	S-N10	FR-BAL-0.75K	—
0.2	FR-S510WE-0.2K	30AF/15A	S-N10	FR-BAL-1.5K	—
0.4	FR-S510WE-0.4K	30AF/20A	S-N20, S-N21	FR-BAL-2.2K	—
0.75	FR-S510WE-0.75K	30AF/30A	S-N20, S-N21	FR-BAL-3.7K	—

\*1. •Select the NFB according to the inverter power supply capacity.

•Install one NFB per inverter.

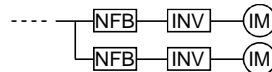

\*2. For installations in the United States or Canada, the circuit breaker must be inverse time or instantaneous trip type.

\*3. The power factor may be slightly lower.

\*4. When the breaker on the inverter primary side trips, check for the wiring fault (short circuit), damage to internal parts of the inverter, etc. Identify the cause of the trip, then remove the cause and power on the breaker.

\*5. The single-phase 100V power input model does not allow the power factor improving DC reactor to be fitted.

## 2. INSTALLATION METHOD

### 2.1 Installation of the inverter

Enclosure surface mounting

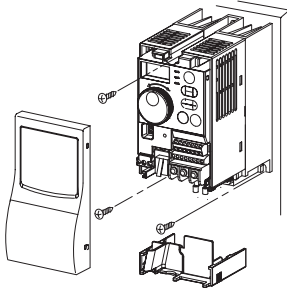

Fix the front cover and wiring cover after removing them.

Leave enough clearances and provide cooling measures.

Encasing multiple inverters

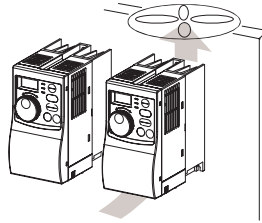

When containing two or more inverters, install them in parallel and provide cooling measures.

- Install the inverter under the following conditions.

Vertical mounting

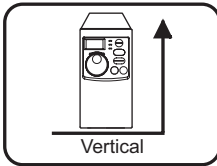

Ambient temperature and humidity

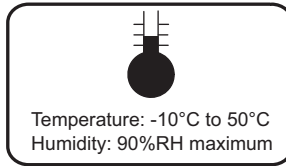

Clearances

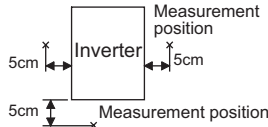
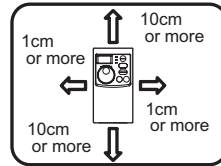

These clearances are also necessary for changing the cooling fan. (The 1.5K or more is provided with a cooling fan.)

- Inverter consists of precision mechanical and electronic parts. Never install or handle it in any of the following conditions as doing so could cause an operation fault or failure.

<p>Direct sunlight</p>	<p>Vibration (<math>5.9\text{m/s}^2</math> or more)</p>	<p>High temperature, high humidity</p>	<p>Horizontal placement</p>
<p>Vertical mounting (when mounted inside enclosure)</p>	<p>Transportation by holding front cover or dial</p>	<p>Oil mist, flammable gas, corrosive gas, fluff, dust, etc.</p>	<p>Mounting to combustible material</p>

# 3. SPECIFICATIONS OF WIRING AND TERMINALS

## 3.1 Terminal connection diagram

- Three-phase 200V power input
- Three-phase 400V power input

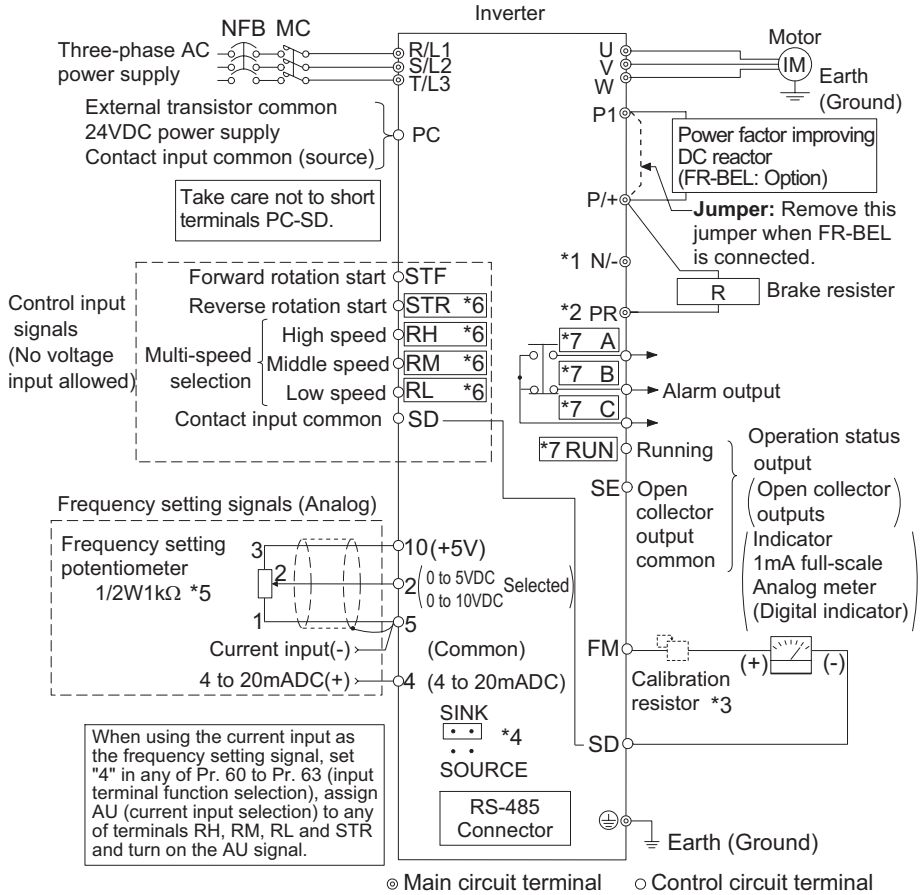

### REMARKS

- \*1. The N/- terminal is not provided for the FR-S520E-0.1K to 0.75K.
- \*2. The PR terminal is provided for the FR-S520E-0.4K to 3.7K.
- \*3. Not needed when the setting dial is used for calibration. Used when calibration must be made near the frequency meter for such a reason as a remote frequency meter. However, the frequency meter needle may not deflect to full-scale if the calibration resistor is connected. In this case, use this resistor and setting dial together.
- \*4. You can switch the position of sink and source logic. Refer to the instruction manual (detailed) for details.
- \*5. When the setting potentiometer is used frequently, use a 2W1kΩ potentiometer.
- \*6. The terminal functions change with input terminal function selection (Pr. 60 to Pr. 63). (Refer to page 40.) (RES, RL, RM, RH, RT, AU, STOP, MRS, OH, REX, JOG, X14, X16, (STR) signal selection)
- \*7. The terminal function changes with the setting of output terminal function selection (Pr. 64, Pr. 65). (Refer to page 40.) (RUN, SU, OL, FU, RY, Y12, Y13, FDN, FUP, RL, Y93, Y95, LF, ABC signal selection)

**CAUTION**

To prevent a malfunction due to noise, keep the signal cables more than 10cm away from the power cables.

- Single-phase 200V power input
- Single-phase 100V power input



**REMARKS**

- To ensure safety, connect the power input to the inverter via a magnetic contactor and earth leakage circuit breaker or no-fuse breaker, and use the magnetic contactor to switch power on-off.
- The output is three-phase 200V.

## 3.2 Main circuit

### 3.2.1 Explanation of main circuit terminals

Terminal Symbol	Terminal Name	Description
R/L1, S/L2, T/L3 (*1)	<b>AC power input</b>	Connect to the commercial power supply.
U, V, W	<b>Inverter output</b>	Connect a three-phase squirrel-cage motor.
P/+, PR (*2)	<b>Brake resistor connection</b>	Connect the optional brake resistor (MRS/MYS type, FR-ABR) (The brake resistor can be connected to the FR-S520E-0.4K to 3.7K only.)
N/-	<b>DC voltage common</b>	DC voltage common terminal. This is not insulated from the power and inverter output. (The N/- terminal is not provided for the FR-S520E-0.1K to 0.75K.)
P/+, P1	<b>Power factor improving DC reactor connection</b>	Remove the jumper across terminals P - P1 and connect the optional power factor improving DC reactor (FR-BEL(-H)). (The single-phase 100V power input model cannot be connected.)
	<b>Earth (ground)</b>	For earthing (grounding) the inverter chassis. Must be earthed (grounded).

\*1. When using single-phase power input, terminals are R/L1 and S/L2.

\*2. The PR terminal is provided for the FR-S520E-0.4K to 3.7K.

### 3.2.2 Terminal block layout

#### 1) Three-phase 200V power input

- FR-S520E-0.1K, 0.2K (-C)

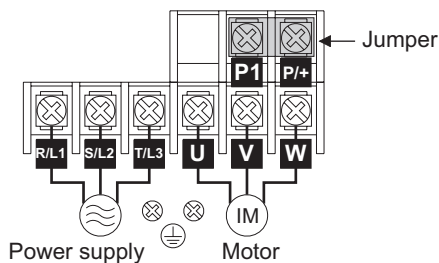

- FR-S520E-1.5K, 2.2K, 3.7K (-C)

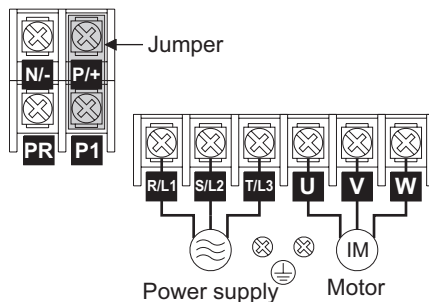

- FR-S520E-0.4K, 0.75K (-C)

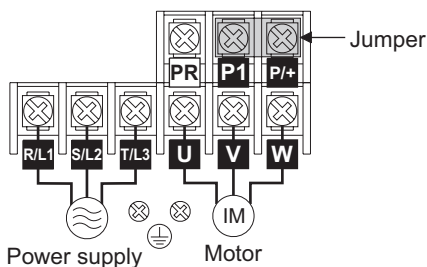

#### 2) Three-phase 400V power input

- FR-S540E-0.4K, 0.75K, 1.5K, 2.2K, 3.7K (-C)

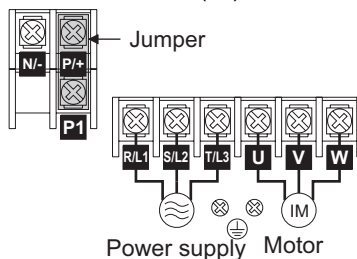

3) Single-phase 200V power input

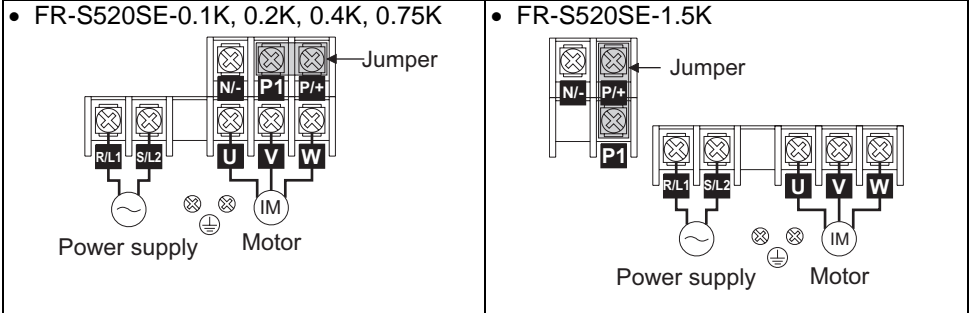

4) Single-phase 100V power input

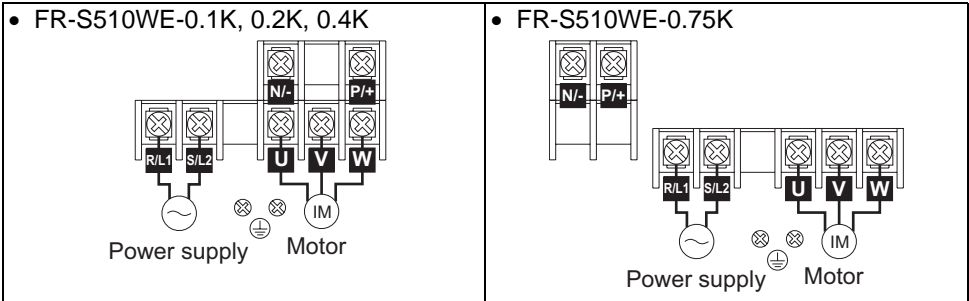

**CAUTION**

- Make sure the power cables are connected to the R/L1, S/L2, T/L3 of the inverter. Never connect the power cable to the U, V, W of the inverter. (Phase need not be matched)
- Connect the motor to U, V, W. At this time, turning on the forward rotation switch (signal) rotates the motor in the counterclockwise direction when viewed from the motor shaft.

### 3.2.3 Cables, wiring length, and crimping terminals

The following table indicates a selection example for the wiring length of 20m.

#### 1) FR-S520E-0.1K to 3.7K (-C)

Applied Inverter	Terminal Screw size	Tightening Torque N·m	Crimping Terminal		Cable				PVC Insulation Cable	
					mm <sup>2</sup>		AWG		mm <sup>2</sup>	
					R, S, T	U, V, W	R, S, T	U, V, W	R, S, T	U, V, W
FR-S520E-0.1K to 0.75K (-C)	M3.5	1.2	2-3.5	2-3.5	2	2	14	14	2.5	2.5
FR-S520E-1.5K, 2.2K (-C)	M4	1.5	2-4	2-4	2	2	14	14	2.5	2.5
FR-S520E-3.7K (-C)	M4	1.5	5.5-4	5.5-4	3.5	3.5	12	12	4	2.5

#### 2) FR-S540E-0.4K to 3.7K

Applied Inverter	Terminal Screw size	Tightening Torque N·m	Crimping Terminal		Cable				PVC Insulation Cable	
					mm <sup>2</sup>		AWG		mm <sup>2</sup>	
					R, S, T	U, V, W	R, S, T	U, V, W	R, S, T	U, V, W
FR-S540E-0.4K to 3.7K	M4	1.5	2-4	2-4	2	2	14	14	2.5	2.5

#### 3) FR-S520SE-0.1K to 1.5K

Applied Inverter	Terminal Screw size	Tightening Torque N·m	Crimping Terminal		Cable				PVC Insulation Cable	
					mm <sup>2</sup>		AWG		mm <sup>2</sup>	
						U, V, W		U, V, W		U, V, W
FR-S520SE-0.1K to 0.75K	M3.5	1.2	2-3.5	2-3.5	2	2	14	14	2.5	2.5
FR-S520SE-1.5K	M4	1.5	2-4	2-4	2	2	14	14	2.5	2.5

#### 4) FR-S510WE-0.1K to 0.75K

Applied Inverter	Terminal Screw size	Tightening Torque N·m	Crimping Terminal		Cable				PVC Insulation Cable	
					mm <sup>2</sup>		AWG		mm <sup>2</sup>	
					R, S	U, V, W	R, S	U, V, W	R, S	U, V, W
FR-S510WE-0.1K to 0.4K	M3.5	1.2	2-3.5	2-3.5	2	2	14	14	2.5	2.5
FR-S510WE-0.75K	M4	1.5	5.5-4	2-4	3.5	2	12	14	4	2.5

#### ● Wiring length

100m maximum. (50m maximum for the FR-S540E-0.4K.)

#### CAUTION

- When the wiring length of the 0.1K or 0.2K is 30m or more, use the carrier frequency of 1kHz.
- Use the carrier frequency of 1kHz when the wiring length of the FR-S540E-0.4K, 0.75K is 30m or more.
- When automatic torque boost is selected in Pr. 98 "automatic torque boost selection (motor capacity)", the wiring length must be 30m maximum. (Refer to page 43.)



## 3.3 Control circuit

### 3.3.1 Explanation of control circuit terminals

Symbol		Terminal Name	Definition		
Input signals	Contact input	STF	<b>Forward rotation start</b>	Turn on the STF signal to start forward rotation and turn it off to stop.	When the STF and STR signals are turned on simultaneously, the stop command is given.
		STR	<b>Reverse rotation start</b>	Turn on the STR signal to start reverse rotation and turn it off to stop.	
		RH RM RL	<b>Multi-speed selection</b>	Turn on the RH, RM and RL signals in appropriate combinations to select multiple speeds. The priorities of the speed commands are in order of jog, multi-speed setting (RH, RM, RL, REX) and AU.	The terminal functions change with input terminal function selection (Pr. 60 to Pr. 63). (*3)
	SD (*1)	<b>Contact input common (sink)</b>	Common to the contact input terminals (STF, STR, RH, RM, RL) and terminal FM. (*6)		
	PC (*1)	<b>External transistor common, 24VDC power supply, contact input common (source)</b>	When connecting the transistor output (open collector output), such as a programmable controller (PLC), connect the positive external power supply for transistor output to this terminal to prevent a malfunction caused by undesirable currents. This terminal can be used as a 24VDC, 0.1A power output across terminals PC-SD. When source logic has been selected, this terminal serves as a contact input common.		
10	<b>Frequency setting power supply</b>	5VDC, Permissible load current 10mA.			
Frequency setting	2	<b>Frequency setting (voltage signal)</b>	By entering 0 to 5VDC (0 to 10VDC), the maximum output frequency is reached at 5V (10V) and I/O are proportional. Switch between 5V and 10V using Pr. 73 "0-5V, 0-10V selection". Input resistance 10kΩ. Maximum permissible input voltage 20V		
		<b>Frequency setting (current signal)</b>	Input 4 to 20mADC. It is factory set at 0Hz for 4mA and at 60Hz for 20mA. Maximum permissible input current 30mA. Input resistance approximately 250Ω. Turn ON signal AU for current input. Turning the AU signal on makes voltage input invalid. Use any of Pr. 60 to Pr. 63 (input terminal function selection) to set the AU signal.		
	5	<b>Frequency setting input common</b>	Frequency setting signal (terminal 2, 4) common terminal. (*6)		

Symbol	Terminal Name	Definition		
Output signals	A B C	<b>Alarm output</b> 1 contact output which indicates that the protective function of the inverter is activated to stop output. 230VAC 0.3A, 30VDC 0.3A. Alarm: discontinuity across B-C (continuity across A-C), Normal: continuity across B-C (discontinuity across A-C).(*5)	Output terminal function selection (Pr.64, Pr.65) changes the terminal functions. (*4)	
	Open collector	RUN		<b>Inverter running</b> Switched low when the inverter output frequency is equal to or higher than the starting frequency (factory set to 0.5Hz variable). Switched high during stop or DC injection brake operation. (*2) Permissible load 24VDC 0.1A (a voltage drop is 3.4V maximum when the signal is on)
	SE	<b>Open collector common</b>		Common terminal for inverter running terminal RUN. (*6)
	Indicator	FM		<b>For meter</b> The output signal across terminals FM-SD is factory set to about 1mA at 60Hz and is proportional to the corresponding output frequency. Since output voltage is pulse shape, a digital meter can be connected. Frequency permissible load current 1mA Pulse specification 1440 pulses/s at 60Hz
Communication	—	<b>RS-485 connector</b> Using the parameter unit connection cable (FR-CB201 to 205), the parameter unit (FR-PU04) can be connected. Communication operation can be performed using RS-485. For details of RS-485 communication, refer to the separately available instruction manual (detailed).		

- \*1. Do not connect terminals SD and PC each other or to the earth (ground). For sink logic (factory setting), terminal SD acts as the common terminal of contact input. For source logic, terminal PC acts as the common terminal of contact input. (Refer to the separately available instruction manual (detailed) for switching method.)
- \*2. Low indicates that the open collector output transistor is on (conducts). High indicates that the transistor is off (does not conduct).
- \*3. RL, RM, RH, RT, AU, STOP, MRS, OH, REX, JOG, RES, X14, X16, (STR) signal selection (Refer to page 40.)
- \*4. RUN, SU, OL, FU, RY, Y12, Y13, FDN, FUP, RL, Y93, Y95, LF, ABC signal selection (Refer to page 40.)
- \*5. To be compliant with the European Directive (Low Voltage Directive), the operating capacity of relay outputs (A, B, C) should be 30VDC 0.3A.
- \*6. Terminals SD, SE and 5 are isolated from each other. Do not earth (ground).

### 3.3.2 Arrangement and wiring of control circuit terminals

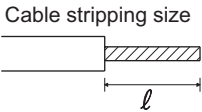
Control circuit terminal block	<table border="1" style="margin: auto; border-collapse: collapse;"> <tr> <td>PC</td><td>SE</td><td>RUN</td><td>10</td><td>2</td><td>5</td><td>4</td> </tr> </table>	PC	SE	RUN	10	2	5	4	 <p style="text-align: center;">Cable stripping size <math>l</math></p>	
	PC	SE	RUN	10	2	5	4			
	<table border="1" style="margin: auto; border-collapse: collapse;"> <tr> <td>SD</td><td>SD</td><td>STF</td><td>STR</td><td>RL</td><td>RM</td><td>RH</td><td>FM</td> </tr> </table>	SD	SD	STF	STR	RL	RM	RH		FM
	SD	SD	STF	STR	RL	RM	RH	FM		
<table border="1" style="margin: auto; border-collapse: collapse;"> <tr> <td>A</td><td>B</td><td>C</td> </tr> </table>	A	B	C							
A	B	C								
<p>Loosen the terminal screw and insert the cable into the terminal.</p> <p>☞ Screw size: M3 (A, B, C terminals), M2 (other than the above)</p> <p>☞ Tightening torque: 0.5N•m to 0.6N•m (A, B, C terminals) 0.22N•m to 0.25N•m (other than the above)</p> <hr/> <p><b>CAUTION</b></p> <p><b>Undertightening can cause cable disconnection or malfunction. Overtightening can cause a short circuit or malfunction due to damage to the screw or unit.</b></p> <hr/> <p>☞ Cable size: 0.3mm<sup>2</sup> to 0.75mm<sup>2</sup></p> <p>☞ Screwdriver: Small ⊖ flat-blade screwdriver Tip thickness: 0.4mm Tip width: 2.5mm</p>		<p>Wire the stripped cable after twisting it to prevent it from becoming loose. In addition, do not solder it. *</p> <table border="1" style="margin: auto; border-collapse: collapse;"> <tr> <td></td> <td style="text-align: center;"><math>l</math></td> </tr> <tr> <td>ABC terminals</td> <td style="text-align: center;">6mm</td> </tr> <tr> <td>Other than the above</td> <td style="text-align: center;">5mm</td> </tr> </table>		$l$	ABC terminals	6mm	Other than the above	5mm		
	$l$									
ABC terminals	6mm									
Other than the above	5mm									

\*Information on bar terminals

Introduced products (as of October, 2003): Phoenix Contact Co.,Ltd.

Terminal Screw Size	Bar Terminal Model (With Insulation Sleeve)	Bar Terminal Model (Without Insulation Sleeve)	Wire Size (mm <sup>2</sup> )
<b>M3 (A, B, C terminal)</b>	AI 0.5-6WH	A 0.5-6	0.3 to 0.5
	AI 0.75-6GY	A 0.75-6	0.5 to 0.75
<b>M2 (Other than the above)</b>	AI 0.5-6WH	A 0.5-6	0.3 to 0.5

☞ Bar terminal crimping tool: CRIMPFOX ZA3 (Phoenix Contact Co., Ltd.)

#### CAUTION

**When using the bar terminal (without insulation sleeve), use care so that the twisted wires do not come out.**

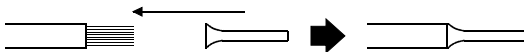

### 3.3.3 Connection to RS-485 connector

- (1) When connecting the parameter unit  
Use the optional FR-CB2□□. When the parameter unit (FR-PU04) is used, operation from the operation panel is not accepted. ( is valid)
- (2) RS-485 communication  
Using the RS-485 connector, you can perform communication operation from a personal computer etc. By connecting the RS-485 connector to computers such as personal computer and FA with a communication cable, you can run/monitor the inverter and read/write parameter values using a user program. For further details, refer to the instruction manual (detailed).
  - Conforming standard: EIA-485 (RS-485)
  - Transmission format: Multi-drop link
  - Communication speed: Maximum 19200 bps
  - Overall extension: 500m

---

**CAUTION**

---

**Do not plug the connector to a computer LAN board, fax modem socket, telephone modular connector etc. As they are different in electrical specifications, the inverter may be damaged.**

---

### 3.3.4 Power-off and magnetic contactor (MC)

#### (1) Inverter primary side magnetic contactor (MC)

On the inverter's primary side, it is recommended to provide an MC for the following purposes. (Refer to page 4 for selection)

- 1) To release the inverter from the power supply when the inverter protective function is activated or the drive becomes faulty (e.g. emergency stop operation)  
When cycle operation or heavy-duty operation is performed with an optional brake resistor connected, overheat and burnout of the electrical-discharge resistor can be prevented if a regenerative brake transistor is damaged due to insufficient heat capacity of the electrical-discharge resistor and excess regenerative brake duty.
- 2) To prevent any accident due to an automatic restart at restoration of power after an inverter stop made by a power failure
- 3) To rest the inverter for an extended period of time  
The control power supply for inverter is always running and consumes a little power. When stopping the inverter for an extended period of time, powering off the inverter will save power slightly.
- 4) To separate the inverter from the power supply to ensure safe maintenance and inspection work

As the inverter's primary MC is used for the above purposes, select class JEM1038-AC3 MC for the inverter primary side current when making an emergency stop during normal operation.

#### REMARKS

The MC may be switched on/off to start/stop the inverter. However, since repeated inrush currents at power on will shorten the life of the converter circuit (switching life is about 100,000 times), frequent starts and stops must be avoided. Turn on/off the inverter start controlling terminals (STF, STR) to run/stop the inverter.

As shown on the right, always use the start signal (ON or OFF across terminals STF or STR-SD) to make a start or stop.

- \*1. When the power supply is 400V class, install a step-down transformer.

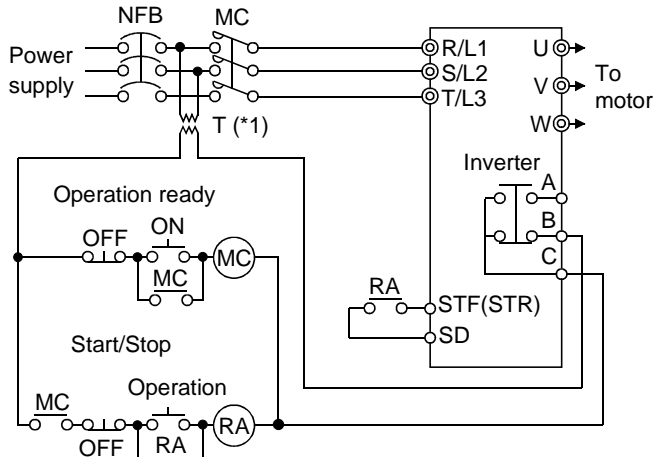

Inverter Start/Stop Circuit Example

#### (2) Handling of secondary side magnetic contactor

In principle, do not provide a magnetic contactor between the inverter and motor and switch it from off to on during operation. If it is switched on during inverter operation, a large inrush current may flow, stopping the inverter due to overcurrent shut-off. When an MC is provided for switching to the commercial power supply, for example, switch it on/off after the inverter and motor have stopped.

## 4. RUN AND OPERATION

### <Operation panel>

The operation panel cannot be removed from the inverter.

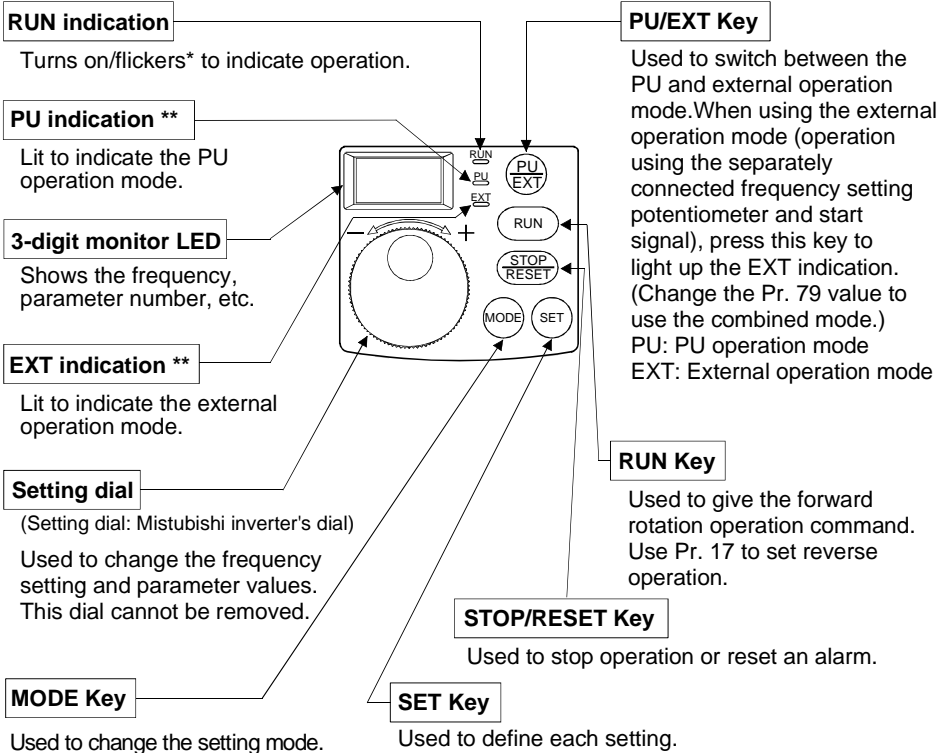

#### \* RUN indication

On: Indicates that forward rotation operation is being performed.

Slow flickering (1.4s cycle): Indicates reverse rotation

Fast flickering (0.2s cycle): Indicates that operation is not being performed but the  was pressed or the start command was given.

#### \*\* PU/EXT indication

Flickers slowly in the computer link operation mode.

### REMARKS

- When the parameter unit (FR-PU04) is used, operation from the operation panel is not accepted. (  is valid)



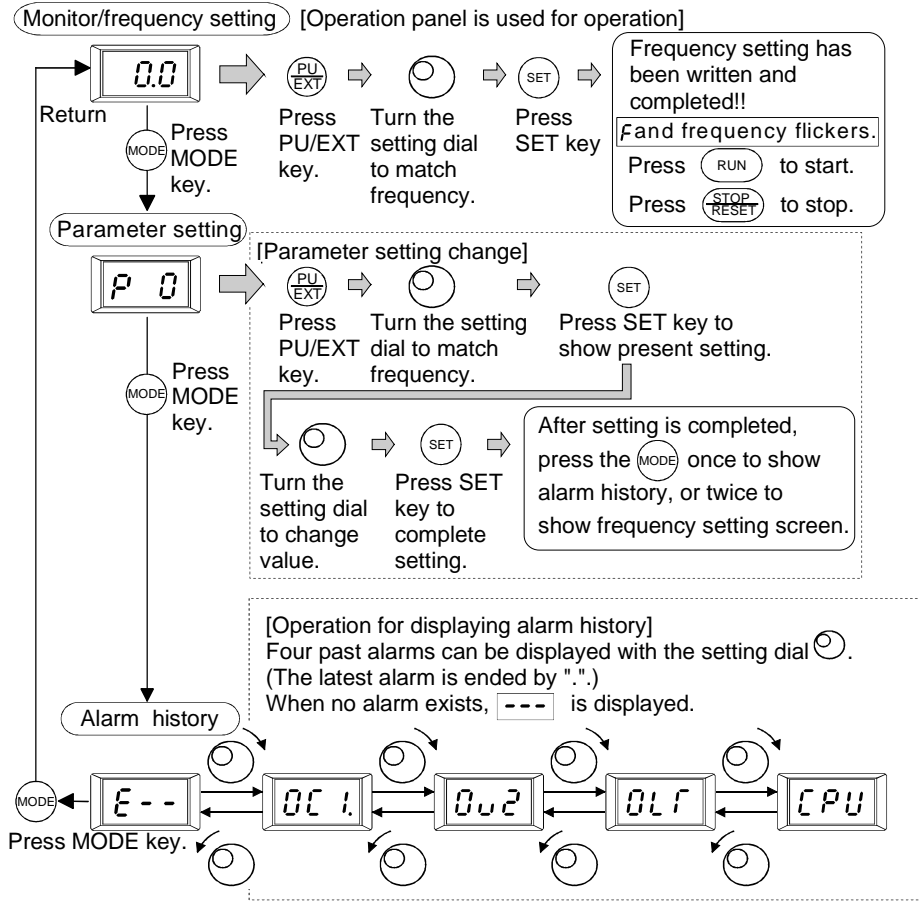













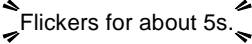



# <Basic operation> (factory setting)



## 4.1 Setting the frequency to perform operation (example: performing operation at 30Hz)

### POINT

- Set "0" (setting dial frequency setting mode) in Pr. 53 "frequency setting operation selection".

- | Operation   | Display   |
|---|---|
| 1. Screen at power-on<br>The monitor display appears.   |    |
| 2. Press the  to choose the PU operation mode.   |  → PU indication is lit.    |
| 3. Turn the  to show the frequency you want to set.<br>Flickers for about 5s.  |  →  Flickers for about 5s.                      |
| 4. While the value is flickering, press the  to set the frequency.<br><br>(If you do not press the  , the value flickers for about 5s and the display then returns to 0.0 (monitor display). At this time, return to "step 3" and set the frequency again.) |  →  ↔ <br>Flicker...Frequency setting complete!! |
| 5. After the value flickered for about 3s, the display returns to 0.0 (monitor display).<br>Press the  to start operation.  |  →  → <br>↓3s later                              |
| 6. To change the set frequency, perform the operation in above steps 3 and 4.<br>(Starting from the previously set frequency.)  |   |
| 7. Press the  to stop.   |  →  →                                      |

### ? Operation cannot be performed at the set frequency ... Why?

- ☞ Did you carry out step 4 within 5s after step 3?

(Did you press the  within 5s after turning the setting dial?)

### ? Setting of higher than 60Hz cannot be made ... Why?

- ☞ Check to see if the Pr. 1 "maximum frequency" setting is 60Hz.

### ? The frequency does not change by turning the setting dial ... Why?

- ☞ Check to see if the operation mode selected is the external operation mode.

### REMARKS

Pressing the setting dial shows the set frequency.



- The setting dial can also be used like a potentiometer to perform operation. (Refer to page 20.)



## 4.2 Using the setting dial like a potentiometer to perform operation

### POINT

- Set "1" (extended function parameter valid) in Pr. 30 "extended function display selection".
- Set "1" (setting dial potentiometer mode) in Pr. 53 "frequency setting operation selection".

**Operation example** Changing the frequency from 0Hz to 60Hz during operation

### Operation

#### 1. Mode/monitor check.

- Choose monitor/frequency monitor. (MODE)
- The inverter must be in the PU operation mode. (Press the PU/EXT.)
- Pr. 30 must be set to "1".
- Pr. 53 must be set to "1".

### Display



#### 2. Press the RUN to start the inverter.



#### 3. Turn the clockwise until "60.0" appears. The flickering frequency is the set frequency.



Flickers for 3s.

You need not press the SET.

### REMARKS

- If flickering "60.0" turns to "0.0", the Pr. 53 "frequency setting operation selection" setting may not be "1".
- Independently of whether the inverter is running or at a stop, the frequency can be set by merely turning the dial.



## 4.3 Setting the parameters

### 4.3.1 Example: Changing the Pr. 7 setting from "5s" to "10s"

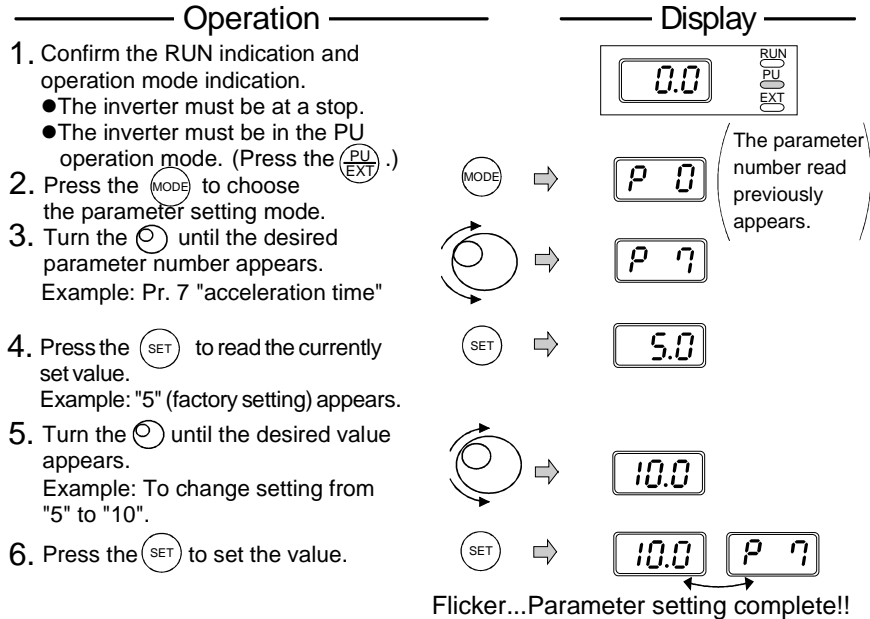
(For parameter details, refer to the instruction manual (detailed).)





Flicker...Parameter setting complete!!

- By turning the , you can read another parameter.
- Press the  to show the setting again.
- Press the  twice to show the next parameter.

After parameter setting is complete, press the  once to show the alarm history or twice to return to the monitor display. To change the setting of another parameter, perform the operation in above steps 3 to 6.

### ? Error display?

-  E-r-1
  - If write was performed with "1" set in Pr. 77
  - If the operation panel does not have the write precedence
-  E-r-2
  - If write was performed during operation
  - If write was performed in the external operation mode



















### Remarks

- If the setting has not been changed, the value does not flicker and the next parameter number appears.
- Either step 1 or 2 may be carried out first.
- Convenient usage

After carrying out steps 1 and 2 to choose the parameter setting mode, you can read a series of parameter numbers in due order every time you press the .



### 4.3.2 Example: Changing the Pr. 30 setting from "0" to "1"

(The extended parameters are made valid by setting "1" in Pr. 30 "extended function display selection". Refer to page 35 for the extended function parameter list and to the instruction manual (detailed) for details.)

Operation	Display
<p>1. Confirm the RUN indication and operation mode indication.</p> <ul style="list-style-type: none"> <li>● The inverter must be at a stop.</li> <li>● The inverter must be in the PU operation mode. (Press the .)</li> </ul>	
<p>2. Press the  to choose the parameter setting mode.</p>	 → 
<p>3. Turn the  until P 30 (Pr. 30) appears.</p>	 → 
<p>4. Press the  to read the currently set value. " 0 " (factory setting) appears.</p>	 → 
<p>5. Turn the  to change it to the set value of " 1 ".</p>	 → 
<p>6. Press the  to set the value.</p>	 →  



Flicker...Parameter setting complete!!

The parameter number read previously appears.

- By turning the , you can read another parameter.
- Press the  to show the setting again.
- Press the  twice to show the next parameter.

After parameter setting is complete, press the  once to show the alarm history or twice to return to the monitor display. To change the setting of another parameter, perform the operation in above steps 3 to 6.

#### ? Error display?

-  Er 1 • If the operation panel does not have the write precedence
-  Er 2 • If write was performed during operation.
- If write was performed in the external operation mode

#### REMARKS

If the setting has not been changed, the value does not flicker and the next parameter number appears.



## 4.4 Clearing the parameters

### POINT

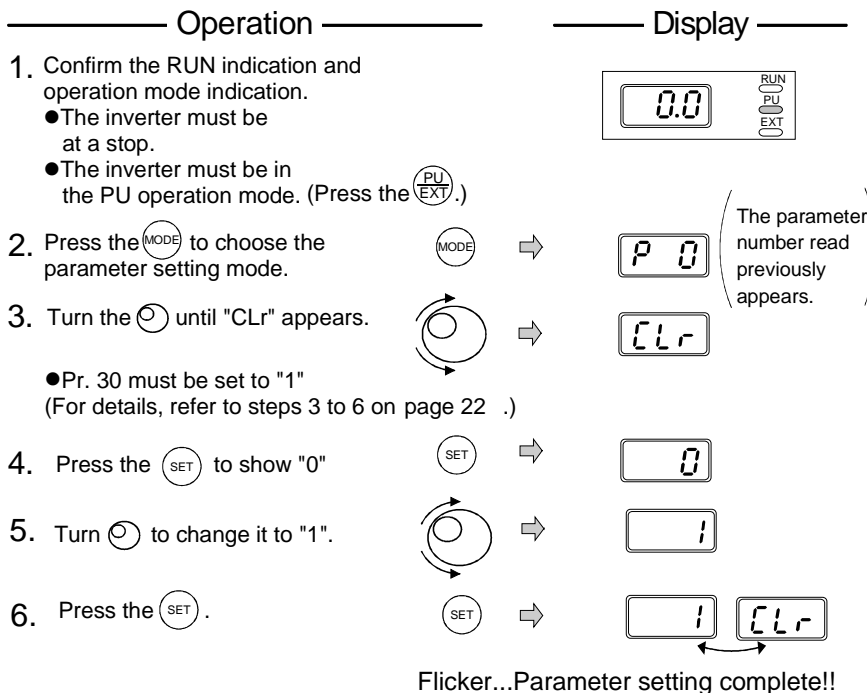
- The clear parameter CLr is an extended parameter. Set "1" in Pr. 30 and turn the dial to show it. (Refer to page 22.)
- The parameters can be cleared by setting "1" in CLr "parameter clear".



The parameter number read previously appears.

- By turning the , you can read another parameter.
- Press the  to show Pr.0 (P 0).

CLr Setting	Definition
<b>0</b>	Not executed.
<b>1</b>	Parameter clear *1 (Calibration parameters C1 to C7 are not cleared.)
<b>10</b>	All clear *2 (All set values including those of calibration parameters C1 to C7 are returned to factory settings.)

- \*1. Parameters are not cleared when "1" is set in Pr. 77 "parameter write disable selection".
- \*2. Pr. 75 "reset selection/PU stop selection", Pr. 38, Pr. 39, Pr. 53, Pr. 60 to Pr. 65, Pr. 99, maintenance parameters H1, H2, calibration parameters C1 to C7 and communication parameters n13, n 15 are not cleared.
- \*3. Pr. 75 "reset selection/PU stop selection", maintenance parameter H1 "maintenance timer" and communication parameter n13 "PU display language selection" are not cleared.

## 4.5 Monitoring the output current

### POINT

The output current appears while the  is pressed in the monitor mode.

#### Operation

#### Display

1. Press the  to choose the output frequency monitor mode.



2. Independently of whether the inverter is running in any operation mode or at a stop, the output current appears while the  is pressed.

 →

 (1.0A)

Hold down

3. Release the  to return to the output frequency monitor mode.

→



### Remarks

When Pr. 52 = "1", the output current is displayed in the monitor mode and the output frequency appears while the  is pressed.

## 4.6 Adjusting the current amount for frequency setting signal (example: performing operation at 30Hz)

### POINT

- Assign the AU signal to any of the terminal RH, RM, RL, or STR and turn on the AU signal.
- Pr. 62 and Pr. 39 are extended function parameters. Set "1" in Pr. 30. (Refer to page 22.)
- Set "2" (external operation mode) in Pr. 79 "operation mode"

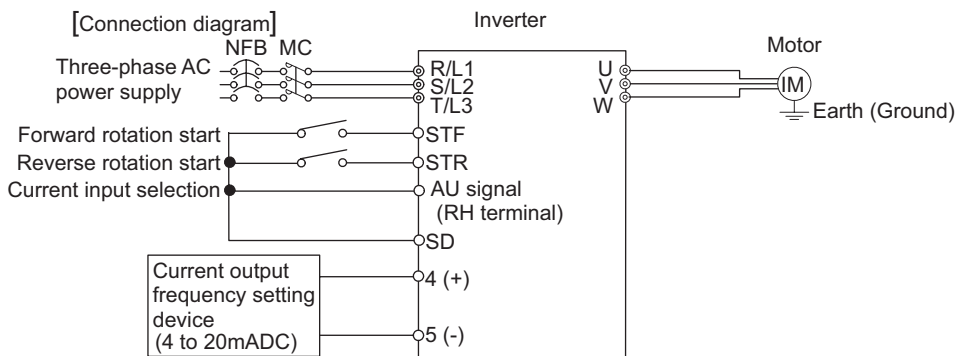

### [AU signal assignment]

- Assign the AU signal to any of the RL, RM, RH or STR terminal.  
(example) Assign the AU signal to the RH terminal.  
Set "4" (AU signal) in Pr. 62 "RH terminal function selection".

### Operation

### Display

1. Confirm the RUN indication and operation mode indication.

- The inverter must be at a stop.
- The inverter must be in the PU operation mode. (Press the **PU/EXT**.)



2. Press the **MODE** to choose the parameter setting mode.



(The parameter number read previously appears.)

3. Turn the **⌚** until P62 (Pr. 62) appears.



4. Press the **SET** to read the currently set value.  
"2" (factory setting) appears.



5. Turn the **⌚** to change it to the set value of "4".



6. Press the **SET** to set the value.



Flicker...AU signal assignment complete!!

### REMARKS

- Refer to page 34, 37 for other parameters' setting.
- Refer to page 40 for details of Pr. 62 "RH terminal function selection".

[Adjust to output 30Hz at 20mA current input]

- Set "30Hz" in Pr. 39.

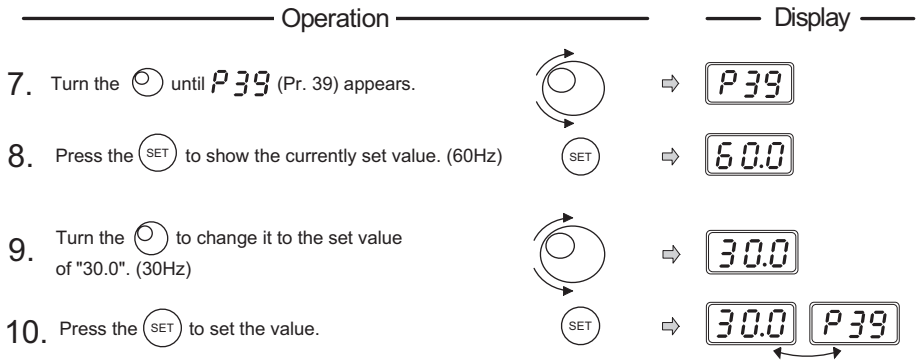

Flicker...30Hz output at 20mA current input setting complete!!

- Apply currents across terminals 4-5 of the inverter with a current output frequency setting potentiometer to turn on the start command (STF, STR). Operation starts at 30Hz.

### REMARKS

- Set frequency at 4mA using calibration parameter C6 and adjust the indicator using calibration parameter C7. (Refer to page 46.)

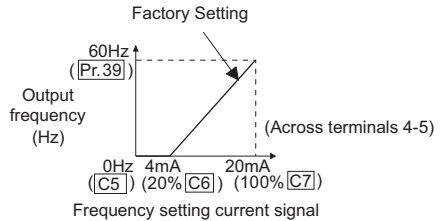

# 5. ADJUSTMENT OF THE FREQUENCY SETTING POTENTIOMETER AND INDICATOR

## ● Related parameters

Parameter	Name	Setting Range	Factory Setting
38	Frequency setting voltage gain frequency	1 to 120Hz	60Hz
39	Frequency setting current gain frequency	1 to 120Hz	60Hz
C2	Frequency setting voltage bias frequency	0 to 60Hz	0Hz
C3	Frequency setting voltage bias	0 to 300%	0% *1
C4	Frequency setting voltage gain	0 to 300%	96% *1
C5	Frequency setting current bias frequency	0 to 60Hz	0Hz
C6	Frequency setting current bias	0 to 300%	20% *1
C7	Frequency setting current gain	0 to 300%	100% *1

\*1. Settings may differ because of calibration parameters.

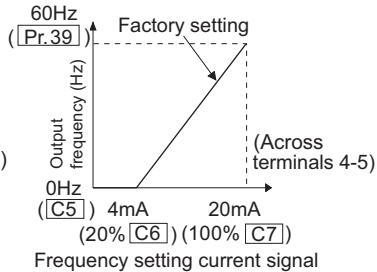
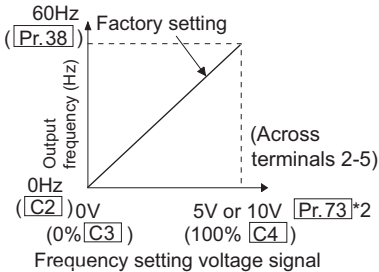

\*2. Pr. 73 "0-5V/0-10V selection" changes the specifications of terminal "2".

### POINT

- Bias setting for 0 to 5VDC (0 to 10VDC) input ➔ Use the calibration parameter C2, C3 for setting
- Gain setting for 0 to 5VDC (0 to 10VDC) input ➔ Use Pr. 38, calibration parameter C4 for setting.
- Bias setting for 4 to 20mADC input ➔ Use the calibration parameter C5, C6 for setting.
- Gain setting for 4 to 20mADC input ➔ Use Pr. 39, calibration parameter C7 for setting.

For 4 to 20mADC input, set "4" in any of Pr. 60 to Pr. 63 (input terminal function selection) and assign AU (current input selection) to any of terminals RH, RM, RL and STR, and turn on the AU signal.



## **5.1 Changing the output frequency setting of the frequency setting potentiometer (bias and gain of frequency setting voltage (current))**

### **POINT**

**Pr. 38, Pr. 39 and calibration parameters "C1 to C7" can be made to be read by setting "1" (extended function parameter valid) in Pr. 30 "extended function display selection".**

The bias/gain of the frequency setting voltage (current) may be adjusted in any of the following methods:

- (1) Changing the highest frequency
- (2) Adjusting the deviation of the highest frequency from the Pr. 38 (Pr. 39) setting
  - (2)-1) Make adjustment with a voltage applied across terminals 2-5 (with a current flowing across terminals 4-5)
  - (2)-2) Make adjustment at any point without a voltage applied across terminals 2-5 (without a current flowing across terminals 4-5) (For the setting method, refer to the instruction manual (detailed).)

Changing example

When you want to use the 0 to 5VDC input frequency setting potentiometer to change the 5V-time frequency from 60Hz (factory setting) to 50Hz.













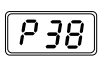

**POINT**

- Pr. 38 is an extended function parameter. Pr. 30 must be set to "1". (Refer to page 22.)
- Change Pr. 38 "frequency setting voltage gain frequency" to 50Hz.

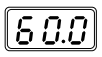

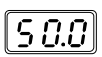
(1) Changing the highest frequency

Operation

Display

1. Confirm the RUN indication and operation mode indication.
  - The inverter must be at a stop.
  - The inverter must be in the PU operation mode. (Press the )
2. Press the  to choose the parameter setting mode.
  →  (The parameter number read previously appears.)
3. Turn the  until Pr. 38 "frequency setting voltage gain frequency" appears.
  → 
  - Pr. 30 must be set to "1" (Refer to steps 3 to 6 on page 22 for the parameter setting method.)
4. Press the  to display the currently set value.(60Hz)
  → 
5. Turn the  to change it to "50.0".(50Hz)
  → 
6. Press the  to set the value.
  → 

Flicker...Parameter setting complete!!

- By turning the , you can read another parameter.
- Press the  to show the setting again.
- Press the  twice to show the next parameter.

? The monitor/frequency setting indication cannot be changed to just 50Hz ...Why?

 The calibration parameter C4 "frequency setting voltage gain" value must be set. (Refer to page 30.)

**REMARKS**

To change the value to more than 60Hz, Pr. 1 "maximum frequency" must be set to more than 60Hz.

Changing example Changing the calibration parameter C4 "frequency setting voltage gain"

**POINT**

The calibration parameter C4 is an extended function parameter. Pr. 30 must be set to "1".

- (2) Adjusting a deviation of the highest frequency from the Pr. 38 (Pr. 39) setting.  
 (2)-1) Making adjustment with a voltage applied directly across terminals 2-5 (with a current flowing across terminals 4-5)

Operation

1. Confirm the RUN indication and operation mode indication.
  - The inverter must be at a stop.
  - The inverter must be in the PU operation mode. (Press the )

Display



2. Press the  to choose the parameter setting mode.



(The parameter number read previously appears.)

3. Turn the  until "C . ." appears.



• Pr. 30 must be set to "1".  
 (For details, refer to steps 3 to 6 on page 22.)

4. Press the  to show "C - ".



**When adjusting Pr. 38**

5. Turn the  until the calibration parameter C4 "frequency setting voltage gain" appears.



6. Press the  to show the analog voltage value (%).



(Analog voltage value (%) across terminals 2-5)

7. Apply a 5V voltage.  
 (Turn the external potentiometer connected to across terminals 2-5 to the maximum (any position).)



\*The value is nearly 100 (%) in the maximum position of the potentiometer.

**CAUTION**



After performing operation in step 7, do not touch the  until completion of calibration.

8. Press the  to set the value.



Flicker ... Parameter setting complete!!  
 (Adjustment complete)

\*The value is nearly 100 (%) in the maximum position of the potentiometer.

- By turning the , you can read another parameter.
- Press the  to return to the "C - " indication (step 4).
- Press the  twice to show the next parameter (C L r).

? The frequency meter (indicator) connected to across terminals FM-SD does not indicate just 50Hz ... Why?

 The calibration parameter C1 "FM terminal calibration" value must be set. (Refer to page 31.)

? When write is performed, an error (E r 3) is displayed.



















 The gain and bias frequency settings are too close.

## 5.2 Adjustment (calibration) of the frequency meter (indicator)

**Changing example** Deflecting the meter (analog indicator) to full-scale (1mA) at the preset frequency of 60Hz.  
(Refer to page 19 for frequency setting.)

### POINT

- The calibration parameters "C1" can be made to be read by setting "1" (extended function parameter valid) in Pr. 30 "extended function display selection".
- Set the value of the calibration parameter C1 "FM terminal calibration".

Operation	Display
PU operation mode	
1. Press the <b>MODE</b> to choose the parameter setting mode.	 →  (The parameter number read previously appears.)
2. Turn the <b>⊖</b> to show "C . .". ● Pr. 30 must be set to "1". (For details, refer to steps 3 to 6 on page 22.)	 → 
3. Press the <b>SET</b> to show "C -".	 → 
4. Turn the <b>⊖</b> until the calibration parameter C1 "FM terminal calibration" appears.	 → 
5. Press the <b>SET</b> to enable setting.	 → 
6. If the inverter is at a stop, press the <b>RUN</b> to start the inverter. (A motor need not be connected.)	 →  → 
7. Turn the <b>⊖</b> to adjust the indicator needle to the desired position.	 →  Analog indicator
8. Press the <b>SET</b> . Setting is complete.	 →  ↔ 

Flicker...Parameter setting complete!!

- By turning the **⊖**, you can read another parameter.
- Press the **SET** to return to the "C -" indication (step 3).
- Press the **SET** twice to show the next parameter ( C L r ).

### REMARKS

- Depending on the set value, it may take some time for the needle to move.
- If "1" is set in Pr. 30 "extended function display selection", the calibration parameter C1 "FM terminal calibration" can also be set in the external operation mode.

### POINT

By setting the Pr. 54 "FM terminal function selection" value, preset Pr. 55 "frequency monitoring reference" or Pr. 56 "current monitoring reference" to the running frequency or current value at which the output signal is 1440 pulses/s. At 1440 pulses/s, the meter generally deflects to full-scale.

## 6. FUNCTION LIST

### 6.1 Basic function parameter list

Parameter	Name	Indication	Setting Range	Minimum Setting Increments	Factory Setting	Customer Setting
0	Torque boost	P 0	0 to 15%	0.1%	6%/5%/4% *	
1	Maximum frequency	P 1	0 to 120Hz	0.1Hz	60Hz	
2	Minimum frequency	P 2	0 to 120Hz	0.1Hz	0Hz	
3	Base frequency	P 3	0 to 120Hz	0.1Hz	60Hz	
4	Multi-speed setting (high speed)	P 4	0 to 120Hz	0.1Hz	60Hz	
5	Multi-speed setting (middle speed)	P 5	0 to 120Hz	0.1Hz	30Hz	
6	Multi-speed setting (low speed)	P 6	0 to 120Hz	0.1Hz	10Hz	
7	Acceleration time	P 7	0 to 999s	0.1s	5s	
8	Deceleration time	P 8	0 to 999s	0.1s	5s	
9	Electronic thermal O/L relay	P 9	0 to 50A	0.1A	Rated output current	
30	Extended function display selection	P30	0, 1	1	0	
79	Operation mode selection	P79	0 to 4, 7, 8	1	0	

\* The factory setting varies with the inverter capacity: 5% for FR-S540E-1.5K and 2.2K, 4% for FR-S540E-3.7K.

#### Remarks

- Setting "1" in Pr. 30 "extended function display selection" makes the extended function parameters valid. (Refer to page 22.)
- The decimal places of a value of 100 or more (3 digits or more) cannot be set to be displayed.

## 6.2 Explanation of the basic function parameters

For details, refer to the separately available instruction manual (detailed).

### Pr. 0 "torque boost"

- Allows the motor torque in the low speed range to be adjusted according to the load. Make adjustment when stall prevention is operated when starting.
- When a constant-torque motor is used, set the following value:

	0.1K to 0.75K	1.5K	2.2K	3.7K
200V class		4%		4%
100V class	6%	4% (6%)		4% (6%)
400V class	6%	4% (5%)	3% (5%)	3% (4%)

Values in parenthesis are factory-set

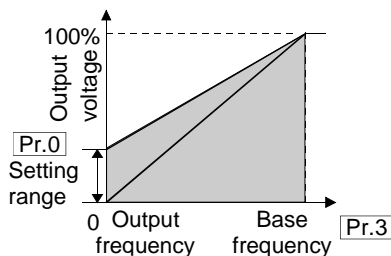

### Pr. 1 "maximum frequency", Pr. 2 "minimum frequency"

- Clamp the upper and lower limits of the output frequency.

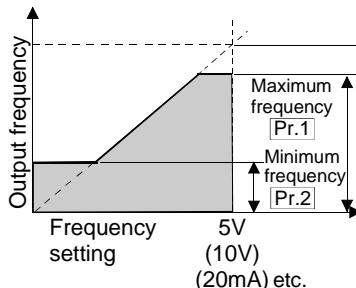

### Pr. 3 "base frequency"

- Set the base frequency (reference frequency at rated motor torque) within the range 0 to 120Hz according to the motor.

### Pr. 7 "acceleration time", Pr. 8 "deceleration time"

- As the acceleration time, set the time taken to reach the acceleration/deceleration reference frequency in Pr. 20 from 0Hz (factory set to 60Hz), and as the deceleration time, set the time taken to reach 0Hz from the Pr. 20 value (factory set to 60Hz).

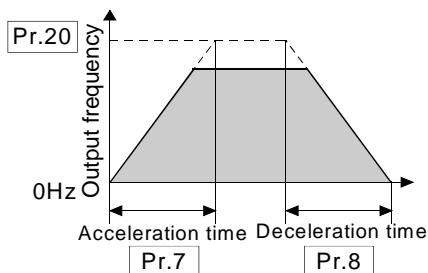

### Pr. 4 "multi-speed setting (high speed)" Pr. 5 "multi-speed setting (middle speed)" Pr. 6 "multi-speed setting (low speed)"

- You can select any speed (RH, RM, RL) by simply switching the external contact signal.

	RH	RM	RL
high-speed	ON	OFF	OFF
middle speed	OFF	ON	OFF
low speed	OFF	OFF	ON

- Each speed (frequency) can be set to any value within the range 0 to 120Hz if the inverter is running.
- The extended functions enable setting of up to 15 speeds.

**Pr. 30 "extended function display selection"**

- Set this parameter when showing/setting the extended function parameters.





Setting	Definition
0	Only basic functions are displayed.
1	All parameters are displayed.

**Pr. 9 "electronic thermal O/L relay"**

- You can set a current value for protection of the motor from overheat. Normally, set the rated motor current at 50Hz as it is.
- At the setting of 0A, motor protection does not function. (The output transistor protection of the inverter functions.)
- When connecting multiple motors to the inverter, provide external thermal relays to individual motors.
- For the 0.75K or less, this value is factory-set to 85% of the rated inverter current.
- Turn the RT signal on to select the second electronic thermal relay function. (Refer to page 44.)

**Pr. 79 "operation mode selection"**

- The inverter has two different operation modes: operation under control of external signals and operation from the PU (setting dial, ). You can use either or both operation modes.

Setting	Definition	
0	PU (setting dial,  ) operation or external operation can be selected by the  .	
1	PU (setting dial,  ) operation may be performed.	
2	Only external operation may be performed.	
3	<b>Running frequency</b>	<b>Start signal</b>
	<ul style="list-style-type: none"> <li>● Setting made by the setting dial</li> <li>● Multi-speed selection</li> <li>● 4 to 20mA (Made valid when the AU signal turns on)</li> </ul>	External terminal (STF/STR)
4	<b>Running frequency</b>	<b>Start signal</b>
	External terminal signals (multi-speed, 0 to 5VDC, etc.)	
7	PU operation interlock (Switching to the PU operation mode is enabled/disabled by turning the MRS signal ON/OFF)	
8	Operation mode external signal switching (disabled during operation) Turn the X16 signal ON/OFF to choose operation mode.	

## 6.3 Extended function parameter list

Setting "1" in Pr. 30 "extended function display selection" makes the extended function parameters valid. (Refer to the separately available instruction manual (detailed).)

Parameter	Indication	Name	Description	Factory Setting
For parameters 0 to 9, refer to the basic function parameters. (page 33)				
10	P 10	DC injection brake operation frequency	Set the timing of switching to DC injection brake (0 to 120Hz), the time to apply DC injection brake (0 to 10s), and the braking torque at DC injection brake start (0 to 15%). (Set Pr. 12 to 4% when a constant-torque motor is used.)	3Hz
11	P 11	DC injection brake operation time		0.5s
12	P 12	DC injection brake voltage		6%
13	P 13	Starting frequency	Frequency which is output by the inverter first at a start and gives great influence to the starting torque. About 1 to 3Hz for vertical lift applications, or up to 5Hz to the maximum. For other than vertical lift applications, factory setting of about 0.5Hz is recommended. 0 to 60Hz	0.5Hz
14	P 14	Load pattern selection	Choose the output frequency and output voltage patterns according to the application (load characteristic). 0: For constant-torque loads (when relatively large torque is needed at low to high speeds) 1: For variable-torque loads (for applications where torque is small at low speed, e.g. fans and pumps) 2: For vertical lifts (for elevators at reverse rotation boost of 0%) 3: For vertical lifts (for elevators at forward rotation boost of 0%)	0
15	P 15	Jog frequency	Speed command (0 to 120Hz) and acceleration/deceleration slope (0 to 999s) for jog (inching) operation When the FR-PU04 is connected, these parameters can be read as the basic parameters.	5Hz
16	P 16	Jog acceleration/deceleration time		0.5s
17	P 17	RUN key rotation direction selection	The  of the operation panel can be used to choose the direction of rotation for operation. 0: Forward rotation, 1: Reverse rotation	0



Parameter		Name	Description	Factory Setting																				
Indication																								
19	P19	Base frequency voltage	Indicates the magnitude of the output voltage at the base frequency (Pr.3) 888: 95% of power supply voltage (1.9 times greater than the power supply voltage for the 100V class) ---: Same as power supply voltage (Twice greater than power supply voltage for 100V class) 0 to 800V, 888, ---	---																				
20	P20	Acceleration/ deceleration base frequency	Indicates the frequency to be referenced for acceleration from or deceleration to 0Hz in the time set in Pr. 7 "acceleration time" or Pr. 8 "deceleration time". 1 to 120Hz	60Hz																				
21	P21	Stall prevention function selection	Stall prevention is a function designed to suspend a frequency increase during acceleration, decrease frequency during constant speed or suspend a frequency decrease during deceleration if the preset current (0 to 200%) is exceeded, in order to prevent an overcurrent alarm. Pr. 21 allows you to select whether to use stall prevention or not according to the acceleration/deceleration status.	0																				
22	P22	Stall prevention operation level	Since the high response current limit value is 170%, torque will not be developed if Pr. 22 is set to more than 170%. In that case, set "1" in Pr. 21.	150%																				
23	P23	Stall prevention operation level compensation factor at double speed	Used to reduce the stall prevention level at or above the base frequency. Setting other than "---" specifies the current level at 120Hz which is lower than the Pr. 22 value of the stall prevention level at base frequency. 0 to 200%, ---	---																				
24	P24	Multi-speed setting (speed4)	Setting other than "---" specifies speeds 4 to 7.	---																				
25	P25	Multi-speed setting (speed 5)	By combining ON and OFF of the contact signals (RH, RM, RL signals), the running speed can be changed step-by-step. <table border="1" style="margin: 10px auto;"> <tr> <td></td> <td>RH</td> <td>RM</td> <td>RL</td> </tr> <tr> <td>Speed 4</td> <td>OFF</td> <td>ON</td> <td>ON</td> </tr> <tr> <td>Speed 5</td> <td>ON</td> <td>OFF</td> <td>ON</td> </tr> <tr> <td>Speed 6</td> <td>ON</td> <td>ON</td> <td>OFF</td> </tr> <tr> <td>Speed 7</td> <td>ON</td> <td>ON</td> <td>ON</td> </tr> </table>		RH	RM	RL	Speed 4	OFF	ON	ON	Speed 5	ON	OFF	ON	Speed 6	ON	ON	OFF	Speed 7	ON	ON	ON	---
	RH	RM		RL																				
Speed 4	OFF	ON		ON																				
Speed 5	ON	OFF		ON																				
Speed 6	ON	ON	OFF																					
Speed 7	ON	ON	ON																					
26	P26	Multi-speed setting (speed 6)	---																					
27	P27	Multi-speed setting (speed 7)	0 to 120Hz, ---	---																				
28	P28	Stall prevention operation reduction starting frequency	You can reduce the stall prevention level in the high frequency range. 0 to 120Hz	60Hz																				

Parameter		Name	Description	Factory Setting
Indication				
29	P29	Acceleration/ deceleration pattern	Determines the frequency changing pattern for acceleration/deceleration. 0: Linear acceleration/deceleration 1: S-pattern acceleration/deceleration A (e.g. machine tool spindle applications) 2: S-pattern acceleration/deceleration B (for prevention of load shifting in conveyor and other applications.)	0
For parameter 30, refer to the basic function parameters. (page 34)				
31	P31	Frequency jump 1A	Set the frequency range you want to evade during constant-speed operation to avoid resonance with a machine. 0 to 120Hz, - - -	---
32	P32	Frequency jump 1B		---
33	P33	Frequency jump 2A		---
34	P34	Frequency jump 2B		---
35	P35	Frequency jump 3A		---
36	P36	Frequency jump 3B		---
37	P37	Speed display	You can convert the frequency monitor/set frequency of the operation panel into the load speed and display it. Setting 0 shows the output frequency, and setting 0.1 to 999 shows the load speed. (Set the speed for 60Hz operation.) 0, 0.1 to 999	0
38	P38	Frequency setting voltage gain frequency	You can set as desired the magnitude (slope) of the output frequency to the external frequency setting voltage signal (0 to 5V or 0 to 10V). 1 to 120Hz	60Hz
39	P39	Frequency setting current gain frequency	You can set as desired the magnitude (slope) of the output frequency to the external frequency setting current signal (4 to 20mA). 1 to 120Hz	60Hz
40	P40	Start-time earth (ground) fault detection selection	Set whether an earth (ground) fault is to be detected or not at a start. 0: Not detected 1: Detected	0
41	P41	Up-to-frequency sensitivity	You can adjust the ON range of the up-to-frequency signal (SU) to be output when the output frequency reaches the running frequency. You can use this function to ensure that the running frequency has been reached or use it as the operation start signal etc. for related equipment. Use Pr. 64 or Pr. 65 to assign the terminal used for SU signal output. 0 to 100%	10%

**Extended function parameter list**

Parameter		Name	Description	Factory Setting
Indication				
42	P42	Output frequency detection	Set the reference value at which the signal (FU) is output when the output frequency rises to or above a certain value. This function can be used for electromagnetic brake operation, open signal, etc. Use Pr. 64 or Pr. 65 to assign the terminal used for the FU signal. 0 to 120Hz	6Hz
43	P43	Output frequency detection for reverse operation	Set the reference value at which the signal (FU) is output when the output frequency rises to or above a certain value. This function is valid for reverse operation. 0 to 120Hz, - - -	- - -
44	P44	Second acceleration/ deceleration time	Second function of the acceleration/ deceleration time set in Pr. 7, Pr. 8. 0 to 999s	5s
45	P45	Second deceleration time	Second function for the deceleration time set in Pr. 8. 0 to 999s, - - -	- - -
46	P46	Second torque boost	Second function for the torque boost set in Pr. 0. 0 to 15%, - - -	- - -
47	P47	Second V/F (base frequency)	Second function for the base frequency set in Pr. 3 0 to 120Hz, - - -	- - -
48	P48	Output current detection level	Set the level at which the output current detection signal (Y12) is output. 0 to 200%	150%
49	P49	Output current detection signal delay time	When the output current is at or above the output current detection level (Pr. 48) for longer than this period (Pr. 49), the output current detection signal (Y12) is output. 0 to 10s	0s
50	P50	Zero current detection level	Set the level at which the zero current detection signal (Y13) is output. 0 to 200%	5%
51	P51	Zero current detection period	When the output current is at or below the zero current detection level (Pr. 50) for longer than this period (Pr. 51), the zero current detection signal (Y13) is output. 0.05 to 1s	0.5s

Parameter		Name	Description	Factory Setting
	Indication			
52	P52	Operation panel display data selection	You can choose the data displayed on the operation panel. 0: Output frequency 1: Output current 100: Set frequency during stop/output frequency during operation	0
53	P53	Frequency setting operation selection	You can use the setting dial like a potentiometer to perform operation. 0: Setting dial frequency setting mode 1: Setting dial potentiometer mode	0
54	P54	FM terminal function selection	You can choose the indicator connected to the FM terminal. 0: Output frequency monitor 1: Output current monitor	0
55	P55	Frequency monitoring reference	Set the reference value of frequency monitoring. 0 to 120Hz	60Hz
56	P56	Current monitoring reference	Set the reference value of current monitoring. 0 to 50A	Rated output current
57	P57	Restart coasting time	At power restoration after an instantaneous power failure, you can restart the inverter without motor being stopped (with the motor coasting). The inverter begins to restart after this period (Pr. 57) has elapsed after power restoration. When you set "--", a restart is not made.	---
58	P58	Restart cushion time	"0" setting generally does not pose a problem but you can adjust the time (0 to 5s, ---) according to the magnitude of the load. When the restart coasting time (Pr. 57) has elapsed, the output voltage is risen gradually. Set this cushion time (Pr. 58) (0 to 60s). Operation may be performed generally at the factory setting, but you can adjust the time according to the magnitude of the load. Refer to additional parameter H6 for selection of speed search. (Refer to page 44.)	1s
59	P59	Remote setting function selection	You can set the remote setting function which is used when the operation panel is away from the enclosure, for example. 0: Without remote setting function 1: With remote setting function With frequency setting storage function 2: With remote setting function Without frequency setting storage function	0

Parameter		Name	Description	Factory Setting
	Indication			
60	P60	RL terminal function selection	You can select the following input signals. 0: RL (multiple low-speed operation command) 1: RM (multiple middle-speed operation command) 2: RH (multiple high-speed operation command) 3: RT (second function selection) 4: AU (current input selection) 5: STOP (start self-holding selection) 6: MRS (output stop) 7: OH (external thermal relay input) 8: REX (15 multi-speed selection) 9: JOG (jog operation selection) 10: RES (reset) 14: X14 (PID control valid terminal) 16: X16 (PU operation/external operation switching) - - -: STR (reverse rotation start (may be assigned to only STR terminal))	0
61	P61	RM terminal function selection		1
62	P62	RH terminal function selection		2
63	P63	STR terminal function selection		- - -
64	P64	RUN terminal function selection		You can select the following input signals. 0: RUN (inverter running) 1: SU (up-to-frequency) 3: OL (overload warning) 4: FU (output frequency detection) 11: RY (operation ready) 12: Y12 (output current detection) 13: Y13 (zero current detection) 14: FDN (PID lower limit signal) 15: FUP (PID upper limit signal) 16: RL (PID forward/reverse rotation signal) 93: Y93 (current average value monitor signal (can be assigned to the RUN terminal only)) 95: Y95 (maintenance timer alarm) 98: LF (minor failure output) 99: ABC (alarm output)
65	P65	A, B, C terminal function selection	99	
66	P66	Retry selection	You can choose the retry alarm to be activated when the protective function is activated. 0: OC1 to 3, OV1 to 3, THM, THT, BE, GF, OHT, OLT, PE, OPT 1: OC1 to 3, 2: OV1 to 3, 3: OC1 to 3, OV1 to 3	0
67	P67	Number of retries at alarm occurrence	You can set the number of retries to be made when the protective function is activated. 0: No retry 1 to 10: Without alarm output during retry operation 101 to 110: With alarm output during retry operation	0

Parameter		Name	Description	Factory Setting															
Indication																			
68	P68	Retry waiting time	You can set the waiting time from when the protective function is activated until a retry is made. 0.1 to 360s	1s															
69	P69	Retry count display erase	You can display the cumulative number of successful restarts made by retries when the protective function is activated. 0: Cumulative count erase	0															
70	P70	Soft-PWM setting	You can select whether to exercise Soft-PWM control and long wiring mode. When Soft-PWM is valid, you can change the metallic motor tone into an unoffending complex tone. Surge voltage is suppressed regardless of wiring length if the long wiring mode is set for the 400V class. <table border="1" data-bbox="508 564 897 679"> <thead> <tr> <th></th> <th>Soft-PWM</th> <th>Long Wiring Mode</th> </tr> </thead> <tbody> <tr> <td>0</td> <td>without</td> <td>without</td> </tr> <tr> <td>1</td> <td>with</td> <td>without</td> </tr> <tr> <td>10</td> <td>without</td> <td>with</td> </tr> <tr> <td>11</td> <td>with</td> <td>with</td> </tr> </tbody> </table>		Soft-PWM	Long Wiring Mode	0	without	without	1	with	without	10	without	with	11	with	with	1
	Soft-PWM	Long Wiring Mode																	
0	without	without																	
1	with	without																	
10	without	with																	
11	with	with																	
71	P71	Applied motor	Set the motor to be used. 0, 100: Thermal characteristic for Mitsubishi standard motor 1, 101: Thermal characteristic for Mitsubishi constant-torque motor  When "100 or 101" is set, turning on the RT signal set the electronic thermal relay function to the thermal characteristic for the constant-torque motor.	0															
72	P72	PWM frequency selection	You can change the PWM carrier frequency. Increasing this value reduces the motor audible noise, but increases noise and leakage current. The setting is in [kHz]. 0: 0.7kHz, 15: 14.5kHz 0 to 15 (Remarks) Metallic sound may be generated from the motor at sudden deceleration but it is not a fault.	1															
73	P73	0-5V/0-10V selection	You can set the input voltage specification of terminal "2". 0: For 0 to 5VDC input 1: For 0 to 10VDC input	0															
74	P74	Input filter time constant	Valid for eliminating noise of the frequency setting circuit. A larger set value increases the time constant. 0 to 8	1															

Parameter		Name	Description	Factory Setting																																													
Indication																																																	
75	P75	Reset selection/PU stop selection	You can choose the function of the  on the operation panel.	14																																													
						<b>Reset Input</b>	<b>PU Stop Key Input</b>																																										
					0	Normally enabled	Invalid (Valid only in the PU operation mode or combined operation mode (Pr. 79=4))																																										
					1	Enabled only when the protective function is activated																																											
					14	Normally enabled	Valid																																										
15	Enabled only when the protective function is activated																																																
76	P76	Cooling fan operation selection	You can control the operation of the cooling fan built in the inverter. (Operates in power-on status.) 0: The fan normally operates at power on of the inverter. 1: The fan is normally on during inverter operation. The fan switches on/off according to the temperature during a stop of the inverter whose status is monitored.	1																																													
77	P77	Parameter write disable selection	You can choose whether to enable or disable parameter write. 0: Write is enabled only during a stop in the PU operation mode 1: Write disabled (except some parameters) 2: Write during operation enabled (external mode and during operation)	0																																													
78	P78	Reverse rotation prevention selection	You can prevent trouble during reverse operation due to false input of the start signal. 0: Both forward rotation and reverse rotation enabled 1: Reverse rotation disabled 2: Forward rotation disabled	0																																													
For parameter 79, refer to the basic function parameters. (page 34)																																																	
80	P80	Multi-speed setting (speed 8)	Setting other than "-" specifies speeds 8 to 15. By combining ON and OFF of the contact signals (RH, RM, RL, REX signals), the running speed can be changed step-by-step. Use Pr. 63 to assign the REX signal.	---																																													
81	P81	Multi-speed setting (speed 9)		---																																													
82	P82	Multi-speed setting (speed 10)		---																																													
83	P83	Multi-speed setting (speed 11)		---																																													
84	P84	Multi-speed setting (speed 12)		---																																													
85	P85	Multi-speed setting (speed 13)		---																																													
86	P86	Multi-speed setting (speed 14)		---																																													
87	P87	Multi-speed setting (speed 15)		---																																													
			<table border="1"> <thead> <tr> <th></th> <th>RH</th> <th>RM</th> <th>RL</th> <th>REX</th> </tr> </thead> <tbody> <tr> <td>Speed 8</td> <td>OFF</td> <td>OFF</td> <td>OFF</td> <td>ON</td> </tr> <tr> <td>Speed 9</td> <td>OFF</td> <td>OFF</td> <td>ON</td> <td>ON</td> </tr> <tr> <td>Speed 10</td> <td>OFF</td> <td>ON</td> <td>OFF</td> <td>ON</td> </tr> <tr> <td>Speed 11</td> <td>OFF</td> <td>ON</td> <td>ON</td> <td>ON</td> </tr> <tr> <td>Speed 12</td> <td>ON</td> <td>OFF</td> <td>OFF</td> <td>ON</td> </tr> <tr> <td>Speed 13</td> <td>ON</td> <td>OFF</td> <td>ON</td> <td>ON</td> </tr> <tr> <td>Speed 14</td> <td>ON</td> <td>ON</td> <td>OFF</td> <td>ON</td> </tr> <tr> <td>Speed 15</td> <td>ON</td> <td>ON</td> <td>ON</td> <td>ON</td> </tr> </tbody> </table>		RH	RM	RL	REX	Speed 8	OFF	OFF	OFF	ON	Speed 9	OFF	OFF	ON	ON	Speed 10	OFF	ON	OFF	ON	Speed 11	OFF	ON	ON	ON	Speed 12	ON	OFF	OFF	ON	Speed 13	ON	OFF	ON	ON	Speed 14	ON	ON	OFF	ON	Speed 15	ON	ON	ON	ON	0 to 120Hz, ---
	RH	RM	RL	REX																																													
Speed 8	OFF	OFF	OFF	ON																																													
Speed 9	OFF	OFF	ON	ON																																													
Speed 10	OFF	ON	OFF	ON																																													
Speed 11	OFF	ON	ON	ON																																													
Speed 12	ON	OFF	OFF	ON																																													
Speed 13	ON	OFF	ON	ON																																													
Speed 14	ON	ON	OFF	ON																																													
Speed 15	ON	ON	ON	ON																																													

Parameter	Indication	Name	Description	Factory Setting
88	P88	PID action selection	Used to choose the operation of PID control. 20: PID reverse action, 21: PID forward action	20
89	P89	PID proportional band	Used to set the proportional band for PID control. 0.1 to 999%, - - -	100%
90	P90	PID integral time	Used to set the integral time for PID control. 0.1 to 999s, - - -	1s
91	P91	PID upper limit	Used to set the upper limit value for PID control. 0 to 100%, - - -	- - -
92	P92	PID lower limit	Used to set the lower limit value for PID control. 0 to 100%, - - -	- - -
93	P93	PID action set point for PU operation	Used to set the PID action set point for PU operation. 0 to 100%	0%
94	P94	PID differential time	Used to set the differential time for PID control. 0.01 to 10s, - - -	- - -
95	P95	Rated motor slip	Used to set the rated motor slip to make slip compensation. 0 to 50%, - - -	- - -
96	P96	Slip compensation time constant	Used to set the response time of slip compensation. 0.01 to 10s	0.5s
97	P97	Constant output range slip compensation selection	Used to choose whether slip compensation is made or not in the constant output range. 0, - - -	- - -
98	P98	Automatic torque boost selection (Motor capacity)	You can set the motor capacity and exercise automatic torque boost control. When you set "- - -", V/F control is exercised. Set the motor capacity used. <ul style="list-style-type: none"> <li>•The motor capacity should be equal to or one rank lower than the inverter capacity.</li> <li>•The number of motor poles should be 2, 4 or 6. (Only 4 poles for constant-torque motor)</li> <li>•Single-motor operation (one motor run by one inverter) should be performed.</li> <li>•Wiring length from inverter to motor should be within 30m.</li> </ul> When using a constant-torque motor, set "1" in Pr. 71. <Example> For 1.5kW, set "1.5". 0.1 to 3.7kW, - - -	- - -
99	P99	Motor primary resistance	You can set the motor's primary resistance value. (Normally, this parameter need not be set.) 0 to 50Ω, - - -	- - -



● Maintenance parameters

Parameter		Name	Description	Factory Setting
	Indication			
H1	H 1	Maintenance timer	Display the maintenance timer (cumulative energization time) in 1000h increments. Parameter write is not enabled. 0 to 999	0
	(503)			
H2	H 2	Maintenance timer alarm output set time	When the maintenance timer has elapsed the time set in H2, the Y95 signal is output. Assign the Y95 signal with Pr. 64 or Pr. 65. 0 to 999, ---	36 (36000h)
	(504)			
H3	H 3	Current average time	The average value of the output current during constant speed operation and the maintenance timer value are output to the current average value monitor signal (Y93). Y93 signal is output for 20s as 1 cycle in order of start bit for 1s(Hi), output current average value for 0.5 to 9s (Low), maintenance timer value for 2 to 9s (Hi), and end signal (Low). Assign the Y93 signal to the RUN terminal using Pr. 64.	1s
	(555)			
H4	H 4	Data output mask time	Set the time (0.1 to 1s) taken to calculate average value of the output current during constant operation in H3. Set the time (0 to 20s) for not outputting the Y93 signal to invalidate retrieving of output current value in the transient state right after the speed is changed from acceleration/deceleration to constant speed in H4.	0s
	(556)			
H5	H 5	Current average value monitor signal output reference current	Set the current value (0.1 to 999A) when outputting the average value of output current as a low pulse shape for 5s in H5.	1A
	(557)			

● Additional parameters

Parameter		Name	Description	Factory Setting
	Indication			
H6	H 6	Automatic restart after instantaneous power failure selection	You can select whether to use system to detect the motor speed (speed search system) at the time of restart after instantaneous power failure or not 0: with speed search, 1: without speed search, 10: with speed search at starting	1
	(162)			
H7	H 7	Second electronic thermal relay function	Protect the second motor from overheat. Set the rated current value of the second motor. Made valid when the RT signal turns on. Refer to Pr. 9 for its function. 0 to 50A, ---	---
	(559)			

● Brake parameters

Set when using the brake resistor.

(These parameters can be read on only the FR-S520E-0.4K to 3.7K.)

Parameter		Name	Description	Factory Setting
	Indication			
b1	b 1	Regenerative function selection	Set when using the optional dedicated brake resistor. 0: Brake resistor (MRS/MYS type), brake unit (BU type) (1.5K or more) 1: High-duty brake resistor (FR-ABR)	0
	(560)			
b2	b 2	Special regenerative brake duty	Set when using the optional high-duty brake resistor (FR-ABR). Setting can be made when b1=1. Set 10% in Pr. 561 when using the FR-ABR. 0 to 30%	0%
	(561)			

● Calibration parameter

Parameter		Name	Description	Factory Setting
	Indication			
<b>C1</b>	[ 1	FM terminal calibration	You can calibrate the indicator connected to across terminals FM-SD. —	—
	(900)			
<b>C2</b>	[ 2	Frequency setting voltage bias frequency	You can set as desired the magnitude (slope) of the output frequency to the external frequency setting voltage signal (0 to 5V or 0 to 10V). (Bias frequency) 0 to 60Hz	0Hz
	(902)			
<b>C3</b>	[ 3	Frequency setting voltage bias	Used to adjust the analog voltage value of the frequency set in calibration parameter C2. (Bias %) 0 to 300%	0%*
	(902)			
<b>C4</b>	[ 4	Frequency setting voltage gain	Used to adjust the analog voltage value of the frequency set in Pr. 38. (Gain %) 0 to 300%	96%*
	(903)			
<b>C5</b>	[ 5	Frequency setting current bias frequency	You can set as desired the magnitude (slope) of the output frequency to the external frequency setting current signal (4 to 20mA). 0 to 60Hz	0Hz
	(904)			
<b>C6</b>	[ 6	Frequency setting current bias	Used to adjust the analog current value of the frequency set in calibration parameter C5. (Bias %) 0 to 300%	20%*
	(904)			
<b>C7</b>	[ 7	Frequency setting current gain	Used to adjust the analog current value of the frequency set in Pr. 39 (Gain %) 0 to 300%	100%*
	(905)			
<b>C8</b>	[ 8	Parameter for manufacturer setting. Do not set.		
	(269)			
<b>CLr</b>	[ L r	Parameter clear	0: Not executed 1: Initialization of parameters other than calibration values (parameter clear) 10: Initialization of parameters including calibration values (all clear)	0
<b>ECL</b>	[ L L	Alarm history clear	0: Not cleared 1: Alarm history clear	0

\*Settings may differ because of calibration parameters.

● Communication parameters

For details of the program, etc., refer to the instruction manual (detailed) separately available.

**POINT**

**To make RS-485 communication between the inverter and personal computer, the operation mode must be set to the "computer link operation mode".  
Pr. 79 "operation mode selection" ≠ "1, 3, 4"  
and  
communication parameter n10 "link startup mode selection" = "1"**

Parameter	Name	Description	Factory Setting
Indication			
<b>n1</b> (331)	<i>n 1</i> Communication station number*	Set the station number for communication from the RS-485 connector. 0 to 31: Specify the station number of the inverter.	0
<b>n2</b> (332)	<i>n 2</i> Communication speed*	48: 4800bps 96: 9600bps 192: 19200bps	192
<b>n3</b> (333)	<i>n 3</i> Stop bit length*	0: Stop bit length 1 bit/data length 8 1: Stop bit length 2 bits/data length 8 10: Stop bit length 1 bit/data length 7 11: Stop bit length 2 bits/data length 7	1
<b>n4</b> (334)	<i>n 4</i> Parity check presence/absence*	0: Absent 1: With odd parity check 2: With even parity check	2
<b>n5</b> (335)	<i>n 5</i> Number of communication retries	Set the permissible number of retries at occurrence of a data receive error. When you set "- - -", the inverter will not come to an alarm stop if a communication error occurs. 0 to 10, - - -	1
<b>n6</b> (336)	<i>n 6</i> Communication check time interval	Set the interval of communication check time. If a no-communication status persists for longer than the permissible time, the inverter will come to an alarm stop. 0: No communication 0.1 to 999s - - -: Check suspended To make communication, set any value other than 0 in the communication parameter n6 "communication check time interval".	- - -
<b>n7</b> (337)	<i>n 7</i> Waiting time setting*	Set the waiting time from when data is transmitted to the inverter until response is made. 0 to 150ms - - -: Set in communication data	- - -
<b>n8</b> (338)	<i>n 8</i> Operation command source	You can choose whether the operation command is given by the computer or the external terminal. 0: Command source is computer 1: Command source is external terminal	0

Parameter		Name	Description	Factory Setting
	Indication			
<b>n9</b>	n 9	Speed command source	You can choose whether the speed command is given by the computer or the external terminal. 0: Command source is computer 1: Command source is external terminal	0
	(339)			
<b>n10</b>	n 10	Link startup mode selection	You can choose the operation mode at power on or at power restoration after instantaneous power failure. Set "1" to select the computer link operation mode. 0: Mode set in Pr. 79 is established. 1: Started in computer link mode.	0
	(340)			
<b>n11</b>	n 11	CR/LF selection*	0: Without CR/LF 1: With CR, without LF 2: With CR/LF	1
	(341)			
<b>n12</b>	n 12	E <sup>2</sup> PROM write selection	0: Write to RAM and E <sup>2</sup> PROM 1: Write to RAM only (When a reset is performed, the parameter value will be the value of E <sup>2</sup> PROM.)	0
	(342)			

\* Perform a reset after setting parameter. The set values are reflected after a reset.

●Parameters for the PU

When the parameter unit (FR-PU04) is used, operation from the operation panel is not accepted. (  is valid)

Parameter		Name	Outline	Factory Setting
	Indication			
<b>n13</b>	n 13	PU display language selection	0: Japanese, 1: English, 2: German 3: French, 4: Spanish, 5: Italian 6: Swedish, 7: Finish	0
	(145)			
<b>n14</b>	n 14	PU buzzer control	0: Without sound, 1: With sound	1
	(990)			
<b>n15</b>	n 15	PU contrast adjustment	 0 (Light) 63(Dark)	58
	(991)			
<b>n16</b>	n 16	PU main display screen data selection	0: Selectable between output frequency and output current 100: Set frequency (during stop) Output frequency (during operation)	0
	(992)			
<b>n17</b>	n 17	Disconnected PU detection/PU setting lock	0: Without PU disconnection error/PU operation valid 1: Error at PU disconnection/PU operation valid 10: Without PU disconnection error/PU operation invalid	0
	(993)			

**REMARKS**

- The parameter number in parentheses is the one for use with the parameter unit (FR-PU04).
- Set "9999" when setting a value "-" using the parameter unit (FR-PU04).
- Pr. stands for a parameter number.

# 7. ERRORS AND PROTECTIVE FUNCTIONS

## 7.1 About errors (definitions)

When an alarm occurs in the inverter, the protective function is activated to bring the inverter to an alarm stop and the PU display automatically changes to any of the following error (alarm) indications.

For details, refer to the separately available instruction manual (detailed).

### (1) Major failures

Operation Panel Indication	Function Name	Definition
<i>OC 1</i> (OC1)	Overcurrent shut-off during acceleration	The inverter output current rose to or above about 200% of the rated inverter current during acceleration.
<i>OC 2</i> (OC2)	Overcurrent shut-off during constant speed	The inverter output current rose to or above about 200% of the rated inverter current during constant speed operation.
<i>OC 3</i> (OC3)	Overcurrent shut-off during deceleration	The inverter output current rose to or above about 200% of the rated inverter current during deceleration.
<i>Ov 1</i> (OV1)	Regenerative overvoltage shut-off during acceleration	Excessive regenerative energy or surge voltage occurred during acceleration.
<i>Ov 2</i> (OV2)	Regenerative overvoltage shut-off during constant speed	Excessive regenerative energy or surge voltage occurred during constant speed.
<i>Ov 3</i> (OV3)	Regenerative overvoltage shut-off during deceleration or stop	Excessive regenerative energy or surge voltage occurred during deceleration or stop.
<i>rHn</i> (THM)	Motor overload shut-off (Electronic thermal relay function) (*1)	Overload or reduced cooling capability during low-speed operation Protection against burnout due to motor temperature rise
<i>rHr</i> (THT)	Inverter overload shut-off (Electronic thermal relay function) (*1)	Current more than 150% of the rated output current flew and overcurrent shut-off did not occur. Output transistor protection from overheat
<i>Fl n</i> (FIN)	Fin overheat	Temperature rise of the heatsink.
<i>GF</i> (GF)	Start-time output side earth (ground) fault overcurrent protection (*2)	Earth (Ground) fault occurred on the inverter's output side at a start.

\*1. Resetting the inverter initializes the internal thermal integration data of the electronic thermal relay function.

\*2. Activated only when "1" is set in Pr. 40 "start-time earth (ground) fault detection selection".

<b>Operation Panel Indication</b>	<b>Function Name</b>	<b>Definition</b>
<i>OHT</i> (OHT)	External thermal relay (*3)	External thermal relay provided for protection from overheat was actuated (contact open).
<i>OLT</i> (OLT)	Stall prevention (overload)	Stall prevention was activated to drop the running frequency to 0. (OL appears while stall prevention is activated.)
<i>BE</i> (BE)	Brake transistor alarm	Error occurred in the brake circuit, e.g. damaged brake transistors. (can be connected to the FR-S520E-0.4K to 3.7K only)
<i>OPT</i> (OPT)	Communication error	<ul style="list-style-type: none"> <li>• Communication errors occurred consecutively more than the permissible number of retries when the RS-485 connector is used and communication parameter n5 ≠ "- -".</li> <li>• RS-485 communication error occurred.</li> <li>• Communication has broken for a period set in communication parameter n6.</li> </ul>
<i>PE</i> (PE)	Parameter storage device alarm	Error occurred in the parameter stored.
<i>PUE</i> (PUE)	PU disconnected	PU was disconnected when communication parameter n17 = "1".
<i>RET</i> (RET)	Retry count excess	Operation could not be resumed properly within the preset number of retries.
<i>CPU</i> (CPU)	CPU error	Arithmetic operation of the built-in CPU does not end within the predetermined time.

\*3. Activated only when any of Pr. 60 to Pr. 63 (input terminal function selection) is set to OH.

(2) Minor failures

<b>Operation Panel Indication</b>	<b>Function Name</b>	<b>Definition</b>
<i>FN</i> (FN)	Fan trouble	The cooling fan built in the inverter failed (stopped).

(3) Warnings

Operation Panel Indication	Function Name	Definition
<i>OL</i> (OL)	Stall prevention (overcurrent) (*4)	Current more than 150% of the rated inverter current flew in the motor and operation is being performed to prevent the inverter from resulting in overcurrent shut-off.
<i>oL</i> (oL)	Stall prevention (overvoltage)	Regenerative energy of the motor became excessive and operation is being performed to stop the frequency from decreasing to prevent overvoltage shut-off.
<i>PS</i> (PS)	PU stop	Pr. 75 "reset selection/PU stop selection" had been set and a stop was made by pressing the  of the operation panel or parameter unit (FR-PU04).
<i>UV</i> (UV)	Undervoltage	Power supply voltage of the inverter dropped.
<i>Err.</i> (Err)	During reset	During inverter reset (RES signal is ON)

\*4. The stall prevention operation current may be set to any value. It is factory set to 150%.

(4) Write errors

Operation Panel Indication	Function Name	Definition
<i>Er 1</i> (Er1)	Write disable error	<ul style="list-style-type: none"> <li>• Write was performed with "1" set in Pr. 77</li> <li>• Frequency jump setting range overlapped.</li> <li>• Parameter write was performed though the operation panel does not have the write precedence.</li> </ul>
<i>Er 2</i> (Er2)	Write-while-running error/mode designation error	<ul style="list-style-type: none"> <li>• Write was performed during operation.</li> <li>• An attempt was made to change the Pr. 79 setting to the operation mode where the operation command has been input.</li> <li>• Write was performed in the external operation mode.</li> </ul>
<i>Er 3</i> (Er3)	Calibration error	Analog input bias and gain calibration values are too close.

- Major failure: When the protective function is activated, the inverter output is shut-off and an alarm output is provided.
- Minor failure: When the protective function is activated, the output is not shut off. The minor failure signal can be output by making parameter setting. (Set "98" in Pr. 64 or Pr. 65 (output terminal function selection). Refer to page 40 .)



## 7.2 To know the operating status at the occurrence of alarm (only when FR-PU04 is used)

When any alarm has occurred, the display automatically switches to the indication of the corresponding protective function (error). By pressing the **(MON)** at this point without resetting the inverter, the display shows the output frequency. In this way, it is possible to know the running frequency at the occurrence of the alarm. It is also possible to know the current in the same manner. After resetting, you can confirm the definitions in "Alarm History". (For details, refer to the instruction manual of the parameter unit (FR-PU04).)

## 7.3 Correspondence between digital and actual characters

There are the following correspondences between the actual alphanumeric characters and the digital characters displayed on the operation panel:

Actual	Display
0	0
1	1
2	2
3	3
4	4
5	5
6	6
7	7
8	8
9	9

Actual	Display
A	A
B	b
C	C
D	d
E	E
F	F
G	G
H	H
I	I
J	J
L	L

Actual	Display
M	M
N	n
O	O
o	o
P	P
S	S
T	T
U	U
V	V
r	r
-	-

## 7.4 Resetting the inverter

The inverter can be reset by performing any of the following operations. Note that the internal thermal integrated value of the electronic thermal relay function and the number of retries are cleared (erased) by resetting the inverter. Recover about 1s after reset is cancelled.

**Err** (Err) flickers on the operation panel during reset.

- Operation 1 ..... Using the operation panel, perform a reset with the **(STOP RESET)**.  
(Enabled only when the inverter protective function is activated (major failure))
- Operation 2 ..... Cut (off) power once, then switch it on again.
- Operation 3 ..... Turn on the reset signal (RES). (Assign this signal to any of Pr. 60 to Pr. 63.) (Refer to page 40.)

## 7.5 Troubleshooting

### POINTS

Check the corresponding areas. If the cause is still unknown, it is recommended to initialize the parameters (return to factory settings), re-set the required parameter values, and check again.

### 7.5.1 Motor remains stopped

#### 1) Check the main circuit

- Check that a proper power supply voltage is applied (operation panel display is provided).
- Check that the motor is connected properly.
- Check that the jumper across P-P1 is connected.

#### 2) Check the input signals

- Check that the start signal is input.
- Check that both the forward and reverse rotation start signals are not input.
- Check that the frequency setting signal is not zero.
- Check that the AU signal is on when the frequency setting signal is 4 to 20mA.
- Check that the output stop signal (MRS) or reset signal (RES) is not on. (Assign signals MRS and RES using Pr. 60 to Pr. 63 (input terminal function selection).)
- Check that the sink or source jumper connector is fitted securely.

#### 3) Check the parameter settings

- Check that the reverse rotation prevention (Pr. 78) is not selected.
- Check that the operation mode (Pr. 79) setting is correct.
- Check that the bias and gain (C2 to C7) settings are correct.
- Check that the starting frequency (Pr. 13) setting is not greater than the running frequency.
- Check that various operational functions (such as three-speed operation), especially the maximum frequency (Pr. 1), are not zero.

#### 4) Check the load

- Check that the load is not too heavy.
- Check that the shaft is not locked.

#### 5) Others

- Check that the operation panel display does not show an error (e.g. OC1).
- Check that the Pr. 15 "jog frequency" setting is not lower than the Pr. 13 "starting frequency" value.

### 7.5.2 Motor rotates in opposite direction

- Check that the phase sequence of output terminals U, V and W is correct.
- Check that the start signals (forward rotation, reverse rotation) are connected properly.
- Check the setting of Pr. 17 "RUN key rotation direction selection".

### 7.5.3 Speed greatly differs from the setting

- Check that the frequency setting signal is correct. (Measure the input signal level.)
- Check that the following parameter settings are correct (Pr. 1, Pr. 2, Pr. 19, Pr. 38, Pr. 39, Pr. 95, C2 to C7).
- Check that the input signal lines are not affected by external noise. (Use shielded cables)
- Check that the load is not too heavy.

### 7.5.4 Acceleration/deceleration is not smooth

- Check that the acceleration and deceleration time settings are not too short.
- Check that the load is not too heavy.
- Check that the torque boost setting is not too large to activate the stall prevention function.

### 7.5.5 Motor current is large

- Check that the load is not too heavy.
- Check that the torque boost setting is not too large.

### 7.5.6 Speed does not increase

- Check that the maximum frequency setting is correct.
- Check that the load is not too heavy. (In agitators, etc., load may become heavier in winter.)
- Check that the torque boost setting is not too large to activate the stall prevention function.
- Check that the brake resistor is not connected to terminals P-P1 or terminals PR-P1 accidentally. (FR-S520E-0.4K to 3.7K)

### 7.5.7 Speed varies during operation

When slip compensation is selected, the output frequency varies with load fluctuation between 0 and 2Hz. This is a normal operation and is not a fault.

#### 1) Inspection of load

- Check that the load is not varying.

#### 2) Inspection of input signal

- Check that the frequency setting signal is not varying.
- Check that the frequency setting signal is not affected by noise.
- Check for a malfunction due to an undesirable current when the transistor output unit is connected.

#### 3) Others

- Check that the wiring length is not too long.
- Check that GD<sup>2</sup> load is not small. (at the motor GD<sup>2</sup> or smaller)  
..... FR-S540E-1.5K to 3.7K  
If so, set the Pr. 72 "PWM frequency selection" to 6kHz or higher.  
(Check for noise or leakage current problem.)

### 7.5.8 Operation mode is not changed properly

If the operation mode does not change correctly, check the following:

- 1. External input signal ..... Check that the STF or STR signal is off. When it is on, the operation mode cannot be changed.
- 2. Parameter setting ..... Check the Pr. 79 setting. When the Pr. 79 "operation mode selection" setting is "0", switching input power on places the inverter in the external operation mode.

Press the  to switch to the PU operation mode.



For other settings (1 to 8), the operation mode is limited accordingly.

(For details of Pr. 79, refer to page 34.)

### 7.5.9 Operation panel display is not operating

- Make sure that terminals PC-SD are not shorted.
- Make sure that the connector is fitted securely across terminals P-P1.

### 7.5.10 Parameter write cannot be performed

- Make sure that operation is not being performed (signal STF or STR is not ON).
- Check that the  () was pressed.
- Make sure that you are not attempting to set the parameter outside the setting range.
- Make sure that you are not attempting to set the parameter in the external operation mode.
- Check Pr. 77 "parameter write disable selection".

### 7.5.11 Motor produces annoying sound

- Check the Pr. 70 "Soft-PWM setting" and Pr. 72 "PWM frequency selection" settings.
- Make sure that the deceleration time is not too short.

## 7.6 Precautions for maintenance and inspection

---

The inverter is a static unit mainly consisting of semiconductor devices. Daily inspection must be performed to prevent any fault from occurring due to the adverse effects of the operating environment, such as temperature, humidity, dust, dirt and vibration, changes in the parts with time, service life, and other factors.

### 7.6.1 Precautions for maintenance and inspection

For some short time after the power is switched off, a high voltage remains in the smoothing capacitor. When accessing the inverter for inspection, wait for at least 10 minutes after the power supply has been switched off, and then make sure that the voltage across the main circuit terminals P-N of the inverter is not more than 30VDC using a tester, etc.

### 7.6.2 Inspection item

#### (1) Daily inspection

- Basically, check for the following faults during operation.
  - 1) Motor operation fault
  - 2) Improper installation environment
  - 3) Cooling system fault
  - 4) Abnormal vibration, abnormal noise
  - 5) Abnormal overheat, discoloration
- During operation, check the inverter input voltages using a tester.

#### (2) Cleaning

Always run the inverter in a clean status.

When cleaning the inverter, gently wipe dirty areas with a soft cloth immersed in neutral detergent or ethanol.

---

#### CAUTION

---

**Do not use solvent, such as acetone, benzene, toluene and alcohol, as they will cause the inverter surface paint to peel off.**

---

### 7.6.3 Periodic inspection

Check the areas inaccessible during operation and requiring periodic inspection. Consult us for periodic inspection.

- 1) Cooling system fault. .... Clean the air filter, etc.
- 2) Tightening check and retightening ..... The screws and bolts may become loose due to vibration, temperature changes, etc. Check and tighten them. Tighten them according to the specified tightening torque.
- 3) Check the conductors and insulating materials for corrosion and damage.
- 4) Measure insulation resistance.
- 5) Check and replace the cooling fan, smoothing capacitor and relay.

### 7.6.4 Insulation resistance test using megger

- 1) Before performing the insulation resistance test on the external circuit, disconnect the cables from all terminals of the inverter so that the test voltage is not applied to the inverter.
- 2) For the continuity test of the control circuit, use a tester (high resistance range) and do not use the megger or buzzer.
- 3) For the inverter, conduct the insulation resistance test on the main circuit only as shown below and do not perform the test on the control circuit. (use the 500VDC megger)

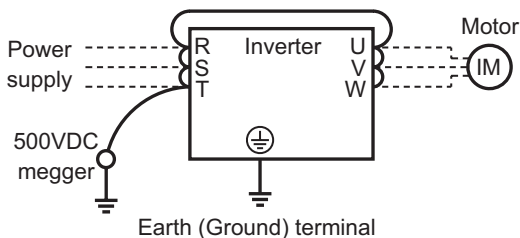

### 7.6.5 Pressure test

Do not conduct a pressure test. Deterioration may occur.

### 7.6.6 Daily and periodic inspection

Area of inspection	Inspection Item	Inspection Item	Interval			Method	Criterion	Instrument	Customer's check
			Daily	Periodic*					
				1 year	2 year				
General	Surrounding environment	Check ambient temperature, humidity, dust, dirt, etc.	○			Measure 5cm away from the inverter.	Ambient temperature: -10°C to +50°C, non-freezing. Ambient humidity: 90% or less, non-condensing.	Thermometer, hygrometer, recorder	
	Overall unit	Check for unusual vibration and noise.	○			Visual and auditory checks.	No fault		
	Power supply voltage	Check that the main circuit voltages are normal.	○			Measure voltages across inverter terminal block R, S, T phases.	Within permissible AC (DC) voltage fluctuation (Refer to page 67.)	Tester, digital multimeter	

**Precautions for maintenance and inspection**

Area of inspection	Inspection Item	Inspection Item	Interval			Method	Criterion	Instrument	Customer's check
			Daily	Periodic*					
				1 year	2 year				
General	General	(1) Check with megger (across main circuit terminals and earth (ground) terminal).			<input type="radio"/>	(1) Disconnect all cables from the inverter and measure across terminals R, S, T, U, V, W and earth terminal with megger., (2) Retighten (3) Visual check	(1) 5MΩ or more (2), (3) No fault	500VDC class megger	
		(2) Check for loose screws and bolts			<input type="radio"/>				
		(3) Check for overheat traces on the parts			<input type="radio"/>				
		(4) Cleaning			<input type="radio"/>				
Main circuit	Conductors, cable	(1) Check conductors for distortion. (2) Check cable sheaths for breakage			<input type="radio"/>	(1), (2) Visual check	(1), (2) No fault		
	Terminal block	Check for damage.			<input type="radio"/>	Visual check	No fault		
	Inverter module, Converter module	Check resistance across terminals.			<input type="radio"/>	Disconnect all cables from the inverter and measure across terminals R, S, T↔P, N and U, V, W↔P, N with a meter range of 100Ω.	Refer to page 60.	Analog tester	
	Smoothing capacitor	(1) Check for liquid leakage. (2) Check for safety valve projection and bulge. (3) Measure electrostatic capacity.	<input type="radio"/>			(1), (2) Visual check (3) Measure with capacity meter	(1), (2) No fault. (3) 85% or more of the rated capacity	Capacity meter	
	Relay	(1) Check for chatter during operation. (2) Check for rough surface on contacts.			<input type="radio"/>	(1) Auditory check (2) Visual check	(1) No fault (2) No fault		

Area of inspection	Inspection Item	Inspection Item	Interval			Method	Criterion	Instrument	Customer's check
			Daily	Periodic*					
				1 year	2 year				
Control circuit Protective circuit	Operation check	(1) Check balance of output voltages across phases with the inverter operated alone.	<input type="radio"/>	<input type="radio"/>		(1) Measure voltages across the inverter output terminals U-V-W. (2) Simulatively short or open the protective circuit output terminals of the inverter.	(1) Phase-to-phase voltage balance Within 4V for the 200V and within 8V for the 400V class (2) Fault must occur because of sequence.	Digital multimeter, rectifier type voltmeter	
		(2) Perform sequence protective operation test to ensure no fault in protective and display circuits.		<input type="radio"/>					
Cooling system	Cooling fan	(1) Check for unusual vibration and noise. (2) Check for loose screws and bolts	<input type="radio"/>			(1) Turn by hand with power off. (2) Visual check	No unusual vibration and noise.		
Display	Indication	(1) Check for LED lamp blown. (2) Cleaning	<input type="radio"/>			(1) Lamps indicate indicator lamps on panel. (2) Clean with rag.	(1) Check that the lamps are lit.		
	Meter	Check that reading is normal.	<input type="radio"/>			Check the readings of the meters on the panel.	Must satisfy specified and management values.	Voltmeter, ammeter, etc.	
Motor	General	(1) Check for unusual vibration and noise. (2) Check for unusual odor.	<input type="radio"/>			(1) Auditory, sensory, visual checks. (2) Check for unusual odor due to overheat, damage, etc.	(1), (2) No fault		
	Insulation resistance	(1) Check with megger (across terminals and earth (ground) terminal).			<input type="radio"/>	(1) Disconnect cables from U, V, W (including motor cables)	(1) 5MΩ or more	500V megger	

Consult us for periodic inspection.



● **Checking the inverter and converter module**

<Preparation>

- (1) Disconnect the external power supply cables (R, S, T) and motor cables (U, V, W).
- (2) Prepare a tester. (Use 100Ω range).

<Checking method>

Change the polarity of the tester alternately at the inverter terminals R, S, T, U, V, W, P and N, and check for continuity.

**CAUTION**

- Before measurement, check that the smoothing capacitor is discharged.
- At the time of discontinuity, the measured value is almost  $\infty$ . When there is an instantaneous continuity, due to the smoothing capacitor, the tester may not indicate  $\infty$ . At the time of continuity, the measured value is several to several ten's-of ohms depending on the module type, circuit tester type, etc. If all measured values are almost the same, the modules are without fault.

**Module device numbers and terminals to be checked**

		Tester Polarity		Process value	Tester Polarity		Process value	
		⊕	⊖		⊕	⊖		
Converter Module	D1	R	P	Discontinuity	D4	R	N	Continuity
		P	R	Continuity		N	R	Discontinuity
	D2	S	P	Discontinuity	D5	S	N	Continuity
		P	S	Continuity		N	S	Discontinuity
	D3	T	P	Discontinuity	D6	T	N	Continuity
		P	T	Continuity		N	T	Discontinuity
Inverter Module	TR1	U	P	Discontinuity	TR4	U	N	Continuity
		P	U	Continuity		N	U	Discontinuity
	TR3	V	P	Discontinuity	TR6	V	N	Continuity
		P	V	Continuity		N	V	Discontinuity
	TR5	W	P	Discontinuity	TR2	W	N	Continuity
		P	W	Continuity		N	W	Discontinuity

(Assumes the use of an analog meter.)

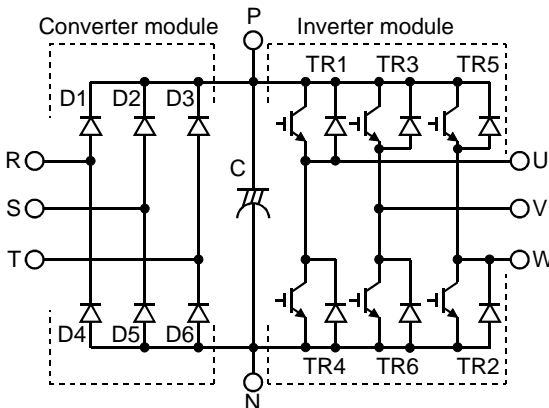

**REMARKS**

The FR-S520SE-0.1K to 1.5K and FR-S510WE-0.1K to 0.75K do not have T, D3 and D6.

### 7.6.7 Replacement of parts

The inverter consists of many electronic parts such as semiconductor devices. The following parts may deteriorate with age because of their structures or physical characteristics, leading to reduced performance or fault of the inverter. For preventive maintenance, the parts must be replaced periodically.

Part Name	Standard Replacement Interval	Description
Cooling fan	2 to 3 years	Replace (as required)
Main circuit smoothing capacitor	10 years *	Replace (as required)
On-board smoothing capacitor	10 years *	Replace the board (as required)
Relays	—	Replace as required

\* The design life of electrolytic capacitor is about ten years (36000h) if used for 10 hours a day and 365 days a year in the average yearly ambient temperature of 40°C.

---

#### CAUTION

---

**For parts replacement, consult the nearest Mitsubishi FA Center.**

---

---

## (1) Cooling fan

The cooling fan is used to cool heat-generating parts such as the main circuit semiconductors. The life of the cooling fan bearing is usually 10,000 to 35,000 hours. Hence, the cooling fan must be replaced every 2 to 3 years if the inverter is run continuously. When unusual noise and/or vibration is noticed during inspection, the cooling fan must be replaced immediately.

Inverter Type	Fan Type
FR-S520E-1.5K, 2.2K, 3.7K FR-S520SE-1.5K	MMF-06D24DS BKO-C2461H07
FR-S540E-1.5K, 2.2K, 3.7K	MMF-06D24ES-FC4 BKO-CA1027H09

### ●Removal

1) Remove the front cover and wiring cover. (Refer to page 2.)

2) Unplug the fan connectors.  
The cooling fan is connected to the cooling fan connector beside the main circuit terminal block of the inverter. Unplug the connector and separate the inverter from the cooling fan.

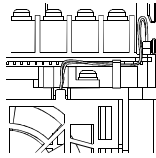

3) Remove the cooling fan cover.  
Disengage the fixing hooks pointed by arrows to remove the cooling fan cover.

4) Remove the cooling fan and cooling fan cover.  
The cooling fan is secured by the fixing hooks. Disengage the fixing hooks to remove the cooling fan and cooling fan cover.

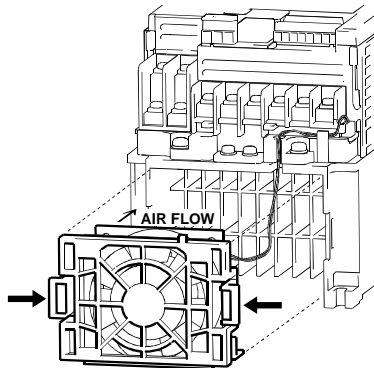

### ●Reinstallation

1) After confirming the orientation of the fan, reinstall the fan so that the arrow on the left of "AIR FLOW" faces up.

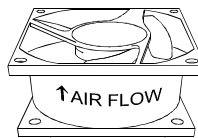

### CAUTION

**Installing the fan in the opposite air flow direction can cause the inverter life to be shorter.**

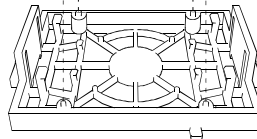

2) Reinstall the fan cover to the inverter.

Run the cable through the wiring groove to prevent it from being caught between the chassis and cover.

3) Reconnect the cable to the connector. (Refer to "Removal" on the previous page for the position of the connector.)

4) Reinstall the wiring cover.

## **(2) Smoothing capacitors**

A large-capacity aluminum electrolytic capacitor is used for smoothing in the main circuit DC section, and an aluminum electrolytic capacitor is used for stabilizing the control power in the control circuit. Their characteristics are deteriorated by the adverse effects of ripple currents, etc. The replacement intervals greatly vary with the ambient temperature and operating conditions. When the inverter is operated in air-conditioned, normal environment conditions, replace the capacitors about every 10 years.

When a certain period of time has elapsed, the capacitors will deteriorate more rapidly. Check the capacitors at least every year (less than six months if the life will be expired soon).

The appearance criteria for inspection are as follows:

- 1) Case: Check the side and bottom faces for expansion
- 2) Sealing plate: Check for remarkable warp and extreme crack.
- 3) Check for external crack, discoloration, fluid leakage, etc. Judge that the capacitor has reached its life when the measured capacitance of the capacitor reduced below 85% of the rating.

## **(3) Relays**

To prevent a contact fault, etc., relays must be replaced according to the cumulative number of switching times (switching life).

## 7.6.8 Measurement of main circuit voltages, currents and powers

- Measurement of voltages and currents

Since the voltages and currents on the inverter power supply and output sides include harmonics, measurement data depends on the instruments used and circuits measured.

When instruments for commercial frequency are used for measurement, measure the following circuits with the instruments given on the next page.

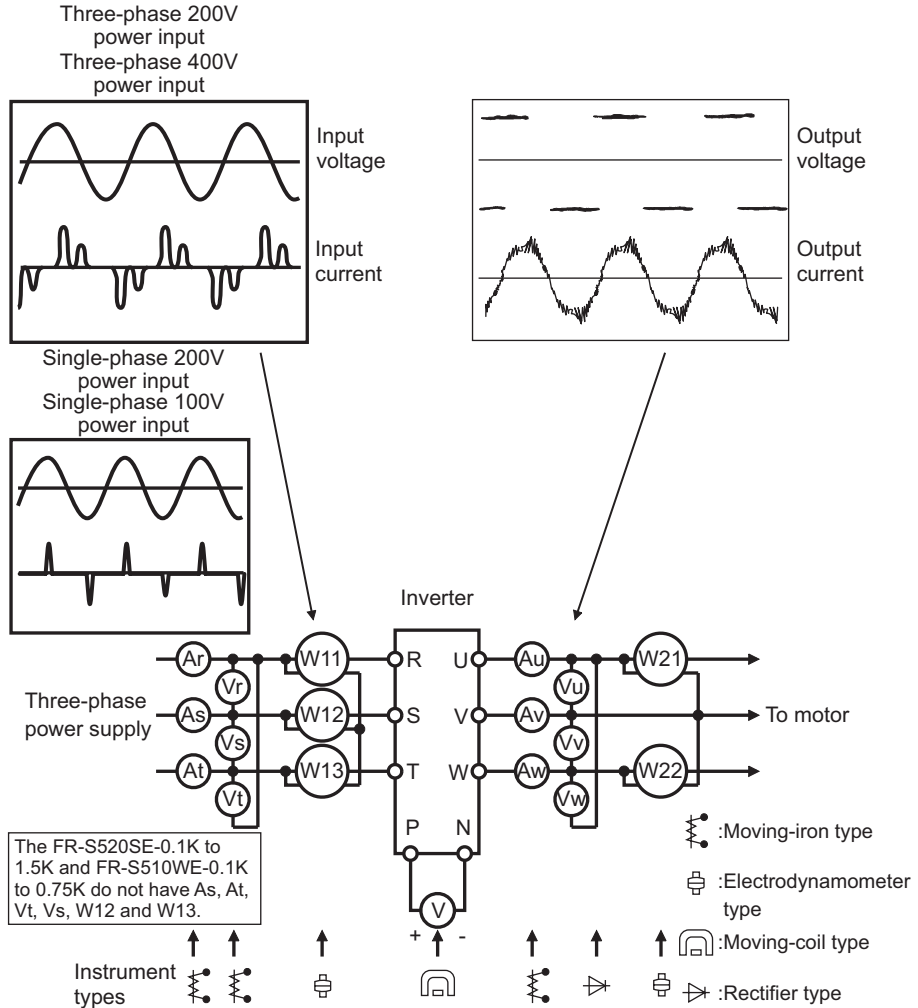

### Examples of Measuring Points and Instruments

#### CAUTION

Use an FFT to measure the output voltages accurately.

A tester or general measuring instrument cannot measure accurately.

## Measuring Points and Instruments

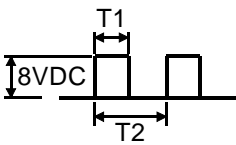
Item	Measuring Point	Measuring Instrument	Remarks (Reference Measurement Value)
Power supply voltage V1	Across R-S, S-T, T-R	Moving-iron type AC voltmeter	Commercial power supply Within permissible AC voltage fluctuation (Refer to page 67.)
Power supply side current I1	R, S, and T line currents	Moving-iron type AC ammeter	
Power supply side power P1	At R, S and T, and across R-S, S-T and T-R	Electrodynamic type single-phase wattmeter	P1 = W11 + W12 + W13 (3-wattmeter method)
Power supply side power factor Pf1	Calculate after measuring power supply voltage, power supply side current and power supply side power. [Three phase power supply]		[For single-phase power supply]  $Pf1 = \frac{P1}{\sqrt{3}V1 \times I1} \times 100\%$
Output side voltage V2	Across U-V, V-W and W-U	Rectifier type AC voltmeter (Caution 1) (Moving-iron type cannot measure)	Difference between the phases is within $\pm 1\%$ of the maximum output voltage.
Output side current I2	U, V and W line currents	Moving-iron type AC ammeter (Caution 2)	Current should be equal to or less than rated inverter current. Difference between the phases is 10% or lower of the rated inverter current.
Output side power P2	U, V, W and U-V, V-W	Electrodynamic type single-phase wattmeter	P2 = W21 + W22 2-wattmeter method (or 3-wattmeter method)
Output side power factor Pf2	Calculate in similar manner to power supply side power factor.  $Pf2 = \frac{P2}{\sqrt{3}V2 \times I2} \times 100\%$		
Converter output	Across P-N	Moving-coil type (such as tester)	Inverter LED display is lit 1.35 × V1
Frequency setting signal	Across 2(+)-5 Across 4(+)-5	Moving-coil type (Tester and such may be used) (Internal resistance: 50kΩ or larger)	0 to 5VDC/0 to 10VDC 4 to 20mADC
Frequency setting power supply	Across 10(+)-5		5VDC
Frequency meter signal	Across FM(+)-SD		Approx. 5VDC at maximum frequency (without frequency meter)
			 <p>Pulse width T1: Adjust with C1 Pulse cycle T2: Set with Pr. 55 (Pr. 56)</p>

ERRORS AND PROTECTIVE FUNCTIONS

**Precautions for maintenance and inspection**

Item	Measuring Point	Measuring Instrument	Remarks (Reference Measurement Value)	
Start signal Select signal	Across STF, STR, RH, RM, RL-SD	Moving-coil type (Tester and such may be used) (Internal resistance: 50kΩ or larger)	When open 20 to 30VDC ON voltage: 1V or less	
Alarm signal	Across A-C Across B-C	Moving-coil type (such as tester)	Continuity check <Normal> <Abnormal> Across A-C: Discontinuity Continuity Across B-C: Continuity Discontinuity	

"SD" is common

**CAUTION**

1. Use an FFT to measure the output voltage accurately. An FA tester or general measuring instrument cannot measure accurately.
2. When the carrier frequency exceeds 5kHz, do not use this instrument since using it may increase eddy-current losses produced in metal parts inside the instrument, leading to burnout.  
In this case, use the approximately effective value type instrument.

## 8. SPECIFICATIONS

### 8.1 Ratings

#### (1) Three-phase 200V power supply

Type FR-S520E-□K (-C)	0.1	0.2	0.4	0.75	1.5	2.2	3.7
Applied motor capacity (kW) (*1)	0.1	0.2	0.4	0.75	1.5	2.2	3.7
Output	Rated capacity (kVA) (*2)	0.3	0.5	1.0	1.6	2.8	6.6
	Rated current (A)	0.8	1.4	2.5	4.1	7.0	16.5
	Overload current rating (*3)	150% 60s, 200% 0.5s (inverse time characteristics)					
Voltage (*4)		Three-phase 200 to 240V 50Hz/60Hz					
Power supply	Rated input AC voltage/frequency	Three-phase 200 to 240V 50Hz/60Hz					
	Permissible AC voltage fluctuation	170 to 264V 50Hz/60Hz					
	Permissible frequency fluctuation	Within $\pm 5\%$					
	Power supply system capacity (kVA) (*5)	0.4	0.7	1.2	2.1	4.0	5.5
Protective structure (JEM1030)	Enclosed type (IP20), IP40 for totally enclosed structure series						
Cooling system	Self-cooling				Forced air cooling		
Approximate weight (kg)	0.5	0.5	0.8	0.9	1.5	1.5	2.1

- \*1. The applied motor capacity indicated is the maximum capacity applicable for use of the Mitsubishi 4-pole standard motor.
- \*2. The rated output capacity indicated assumes that the output voltage is 230V.
- \*3. The % value of the overload capacity indicates the ratio of the overload current to the inverter's rated output current. For repeated duty, allow time for the inverter and motor to return to or below the temperatures under 100% load.
- \*4. The maximum output voltage does not exceed the power supply voltage. You can set the maximum output voltage to any value below the power supply voltage. However, the pulse voltage value of the inverter output side voltage remains unchanged at about  $\sqrt{2}$  that of the power supply.
- \*5. The power supply capacity changes with the values of the power supply side inverter impedances (including those of the input reactor and cables).



**(2) Three-phase 400V power supply**

Type FR-S540E-□K		0.4	0.75	1.5	2.2	3.7
Applied motor capacity (kW) (*1)		0.4	0.75	1.5	2.2	3.7
Output	Rated capacity (kVA) (*2)	0.9	1.6	2.7	3.7	5.9
	Rated current (A)	1.1	2.1	3.5	4.8	7.7
	Overload current rating (*3)	150% 60s 200% 0.5s (Inverse time characteristics)				
	Voltage (*4)	Three phase, 380V to 480V 50Hz/60Hz				
Power supply	Rated input AC voltage/frequency	Three phase, 380V to 480V 50Hz/60Hz				
	Permissible AC voltage fluctuation	325 to 528V 50Hz/60Hz				
	Permissible frequency fluctuation	±5%				
	Power supply system capacity (kVA) (*5)	1.5	2.5	4.5	5.5	9.5
Protective structure (JEM1030)		Enclosed type (IP20)				
Cooling system		Self-cooling		Forced air cooling		
Approximate weight (kg)		1.5	1.5	1.5	1.6	1.7

- \*1. The applied motor capacity indicated is the maximum capacity applicable for use of the Mitsubishi 4-pole standard motor.
- \*2. The rated output capacity indicated assumes that the output voltage is 440V.
- \*3. The % value of the overload capacity indicates the ratio of the overload current to the inverter's rated output current. For repeated duty, allow time for the inverter and motor to return to or below the temperatures under 100% load.
- \*4. The maximum output voltage does not exceed the power supply voltage. You can set the maximum output voltage to any value below the power supply voltage. However, the pulse voltage value of the inverter output side voltage remains unchanged at about  $\sqrt{2}$  that of the power supply.
- \*5. The power supply capacity varies with the value of the power supply side inverter impedance (including those of the input reactor and cables).

## (3) Single-phase 200V power supply

Type FR-S520SE-□K		0.1	0.2	0.4	0.75	1.5
Applied motor capacity (kW) (*1)		0.1	0.2	0.4	0.75	1.5
Output	Rated capacity (kVA) (*2)	0.3	0.5	1.0	1.6	2.8
	Rated current (A)	0.8	1.4	2.5	4.1	7.0
	Overload current rating (*3)	150% 60s 200% 0.5s (Inverse time characteristics)				
	Voltage (*4)	Three phase, 200V to 240V 50Hz/60Hz				
Power supply	Rated input AC voltage/frequency	Single-phase, 200V to 240V 50Hz/60Hz				
	Permissible AC voltage fluctuation	170 to 264V 50Hz/60Hz				
	Permissible frequency fluctuation	±5%				
	Power supply system capacity (kVA) (*5)	0.5	0.9	1.5	2.5	4.4
Protective structure (JEM1030)		Enclosed type (IP20)				
Cooling system		Self-cooling				Forced air cooling
Approximate weight (kg)		0.5	0.6	0.8	1.0	1.5

- \*1. The applied motor capacity indicated is the maximum capacity applicable when a Mitsubishi 4-pole standard motor is used.
- \*2. The rated output capacity indicated assumes that the output voltage is 230V.
- \*3. The % value of the overload capacity indicates the ratio of the overload current to the inverter's rated output current.  
For repeated duty, allow time for the inverter to return to or below the temperatures under 100% load.
- \*4. The maximum output voltage does not exceed the power supply voltage. The maximum output voltage may be set as desired below the power supply voltage. However, the PWM pulse voltage value of the inverter output side voltage remains unchanged at about  $\sqrt{2}$  that of the power supply.
- \*5. The power supply capacity changes with the values of the power supply side inverter impedances (including those of the input reactor and cables).

**(4) Single-phase 100V power supply**

Type FR-S510WE-□K		0.1	0.2	0.4	0.75
Applied motor capacity (kW) (*1)		0.1	0.2	0.4	0.75
Output	Rated capacity (kVA) (*2)	0.3	0.5	1.0	1.6
	Rated current (A)	0.8	1.4	2.5	4.1
	Overload current rating (*3)	150% 60s 200% 0.5s (Inverse time characteristics)			
	Voltage	Three phase, 200V to 230V 50Hz/60Hz (*4, 6)			
Power supply	Rated input AC voltage/frequency	Single-phase, 100V to 115V 50Hz/60Hz			
	Permissible AC voltage fluctuation	90 to 132V 50Hz/60Hz			
	Permissible frequency fluctuation	±5%			
	Power supply system capacity (kVA) (*5)	0.5	0.9	1.5	2.5
Protective structure (JEM1030)		Enclosed type (IP20)			
Cooling system		Self-cooling			
Approximate weight (kg)		0.6	0.7	0.9	1.6

- \*1. The applied motor capacity indicated is the maximum capacity applicable when a Mitsubishi 4-pole standard motor is used.
- \*2. The rated output capacity indicated assumes that the output voltage is 230V.
- \*3. The % value of the overload capacity indicates the ratio of the overload current to the inverter's rated output current.  
For repeated duty, allow time for the inverter to return to or below the temperatures under 100% load.
- \*4. For single-phase 100V power input, the output voltage provided cannot be twice or more than the power supply voltage.
- \*5. The power supply capacity changes with the values of the power supply side inverter impedances (including those of the input reactor and cables).
- \*6. For single-phase 100V power input, the application of motor load reduces the output voltage about 10 to 15%. Therefore, the load must be reduced when a general-purpose motor is used.

## 8.2 Common specifications

Control specifications	Control system		Selectable between Soft-PWM control and high carrier frequency PWM control, selectable between V/F control and automatic torque boost control.
	Output frequency range		0.5 to 120Hz (starting frequency variable between 0 and 60Hz)
	Frequency setting resolution		5VDC input: 1/500 of max. set frequency, 10VDC, 4 to 20mADC input: 1/1000 of max. set frequency Digital input: 0.1Hz (less than 100Hz), 1Hz (100Hz or higher)
	Frequency accuracy		Analog input: Within $\pm 1\%$ of max. output frequency ( $25^{\circ}\text{C} \pm 10^{\circ}\text{C}$ ) Digital input: Within $\pm 0.5\%$ of set output frequency (when set by the setting dial)
	Starting torque		150% (at 5Hz) during automatic torque boost control
	Acceleration/deceleration time setting		0, 0.1 to 999s (acceleration and deceleration can be set individually), linear or S-pattern acceleration/deceleration mode can be selected.
	Braking torque (*2)	Regeneration	0.1K, 0.2K ... 150%, 0.4K, 0.75K ... 100%, 1.5K ... 50%, 2.2K, 3.7K ... 20%
		DC injection brake	Operation frequency (0 to 120Hz), operation time (0 to 10s), operation voltage (0 to 15%)
	Frequency setting signal	Analog input	0 to 5VDC, 0 to 10VDC, 4 to 20mA
		Digital input	Entered from operation panel
	Start signal	STF, STR	Forward and reverse rotation, start signal automatic self-holding input (3-wire input) can be selected.
	Alarm reset		Used to reset alarm output provided when protective function is activated.
	Multi-speed selection		Up to 15 speeds can be selected. (Each speed can be set between 0 and 120Hz, running speed can be changed during operation from the operation panel.)
	Second function selection		Used to select second functions (acceleration time, deceleration time, torque boost, base frequency, electronic thermal relay function).
	Output stop		Instantaneous shut-off of inverter output (frequency, voltage)
Current input selection		Used to select frequency setting signal 4 to 20 mA (terminal 4).	
External thermal relay input		Thermal relay contact input for use when the inverter is stopped by the external thermal relay.	
Jog signal		Jog operation mode selection	
PID control valid		Selection for exercising PID control	
PU operation /external operation switchover		Used to switch between PU operation and external operation from outside the inverter.	

Use  
Pr. 60 to  
Pr. 63 for  
selection

Control specifications	Operational functions		Maximum and minimum frequency settings, frequency jump operation, external thermal relay input selection, automatic restart after instantaneous power failure, forward/reverse rotation prevention, slip compensation, operation mode selection, PID control, computer link operation (RS-485).
	Output signals	Operating Status	1 open collector signal can be selected from among inverter running, up-to-frequency, frequency detection, overload warning, zero current detection, output current detection, PID upper limit, PID lower limit, PID forward/reverse rotation, operation ready, current average value monitor signal, maintenance timer alarm, minor failure and alarm. 1 contact output (1 contact, 230V 0.3AAC, 30V 0.3ADC) signal can be selected.
		For meter	1 signal can be selected from between output frequency and motor current. Pulse train output (1440 pulses/s, 1mA full scale)
Protective/warning function		Overcurrent shut-off (during acceleration, deceleration, constant speed), regenerative overvoltage shut-off (during acceleration, deceleration, constant speed), overload shut-off (electronic thermal relay function), heatsink overheat, fan failure (*3), stall prevention, brake transistor alarm (*4), start-time output side earth (ground) fault protection (*5), external thermal relay (*6), disconnected PU, retry count excess, communication error, CPU error, undervoltage (*1)	
Environment	Ambient temperature	-10°C to +50°C (non-freezing) (-10°C to +40°C for totally enclosed structure feature)	
	Ambient humidity	90%RH or less (non-condensing)	
	Storage temperature (*7)	-20°C to +65°C	
	Atmosphere	Indoors (without corrosive gas, flammable gas, oil mist, dust and dirt etc.)	
	Altitude, vibration	Maximum 1000m above seal level, 5.9m/s <sup>2</sup> or less(conforms to JIS C 0040)	

- \*1. When undervoltage or instantaneous power failure occurs, no alarm output is provided but the output is shut off. After power restoration, the inverter may be run as it is. Depending on the running status (e.g. load magnitude), however, overcurrent, regenerative overvoltage or other protection may be activated at power restoration. (in the external operation mode)
- \*2. The braking torque indicated is a short-duration average torque (which varies with motor loss) when the motor alone is decelerated from 60Hz in the shortest time and is not a continuous regenerative torque. When the motor is decelerated from the frequency higher than the base frequency, the average deceleration torque will reduce. Since the inverter does not contain a brake resistor, use an optional brake resistor when regenerative energy is large. (Available for the FR-S520E-0.4K to 3.7K only.) A brake unit (BU) may also be used.
- \*3. Compatible with only the product having the built-in cooling fan.
- \*4. Available for the FR-S520E-0.4K to 3.7K only.
- \*5. Activated only when "1" is set in Pr. 40 "start-time earth (ground) fault detection selection".
- \*6. Activated only when external thermal relay input (OH) is selected in any of Pr. 60 to Pr. 63 (input terminal function selection).
- \*7. Temperature applicable for a short period such as transportation.

## 9. OUTLINE DRAWINGS

- FR-S520E-0.1K, 0.2K, 0.4K, 0.75K
- FR-S520SE-0.1K, 0.2K, 0.4K, 0.75K
- FR-S510WE-0.1K, 0.2K, 0.4K

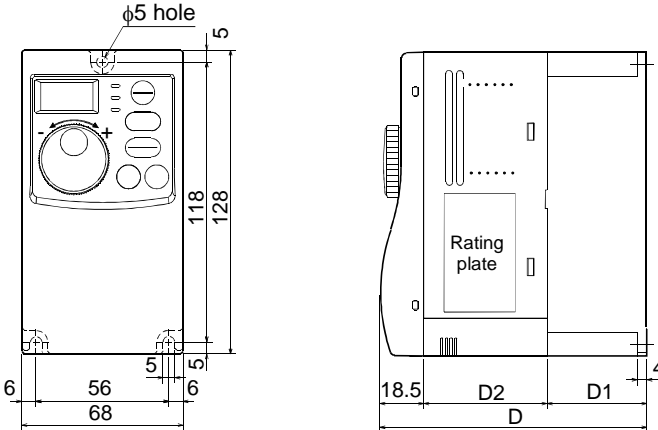

- Three-phase 200V power supply

Capacity	D	D1	D2
0.1K,0.2K	80.5	10	52
0.4K	112.5	42	52
0.75K	132.5	62	52

- Single-phase 200V power supply

Capacity	D	D1	D2
0.1K,0.2K	80.5	10	52
0.4K	142.5	42	82
0.75K	162.5	62	82

- Single-phase 100V power supply

Capacity	D	D1	D2
0.1K	80.5	10	52
0.2K	110.5	10	82
0.4K	142.5	42	82

(Unit: mm)

### REMARKS

For dimensions of the totally enclosed structure type, refer to those of the standard type inverter of the same capacity.

- FR-S520E-1.5K, 2.2K, 3.7K
- FR-S540E-0.4K, 0.75K, 1.5K, 2.2K, 3.7K
- FR-S520SE-1.5K
- FR-S510WE-0.75K

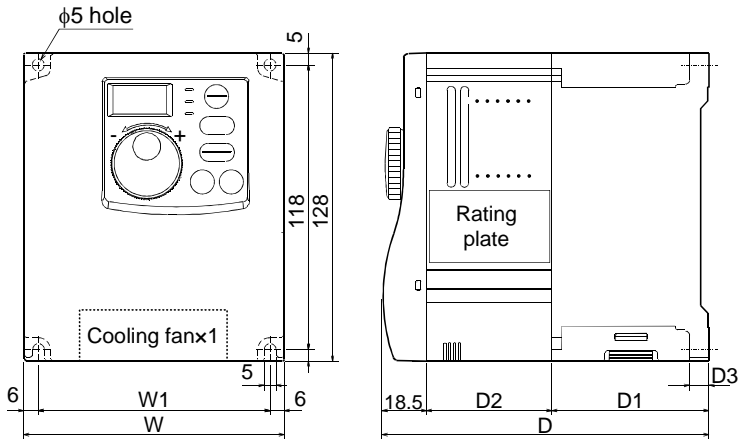

•Three-phase 200V power supply

Capacity	W	W1	D	D1	D2	D3
1.5K,2.2K	108	96	135.5	65	52	8
3.7K	170	158	142.5	72	52	5

•Three-phase 400V power supply

Capacity	W	W1	D	D1	D2	D3
0.4K,0.75K	108	96	129.5	59	52	5
1.5K	108	96	135.5	65	52	8
2.2K	108	96	155.5	65	72	8
3.7K	108	96	165.5	65	82	8

•Single-phase 200V power supply

Capacity	W	W1	D	D1	D2	D3
1.5K	108	96	155.5	65	72	8

•Single-phase 100V power supply

Capacity	W	W1	D	D1	D2	D3
0.75K	108	96	149.5	59	72	5

(Unit: mm)

**REMARKS**

- The FR-S540E-0.4K, 0.75K and FR-S510WE-0.75K do not have a cooling fan.
- For dimensions of the totally enclosed structure type, refer to those of the standard type inverter of the same capacity.

•Parameter unit (FR-PU04)

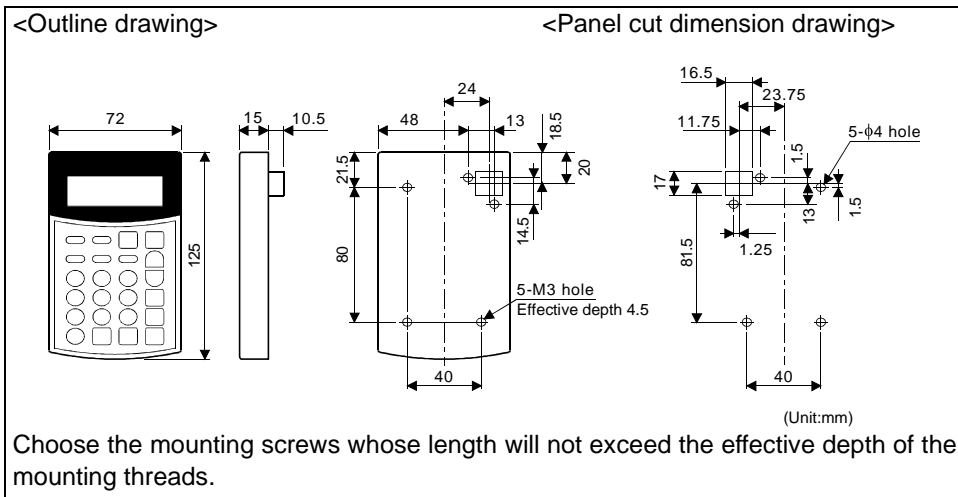



# Appendix 1 Instructions for compliance with the European Directive

(The products conforming to the Low Voltage Directive carry the CE mark.)

## (1) EMC Directive

### 1) Our view of transistorized inverters for the EMC Directive

A transistorized inverter is a component designed for installation in an enclosure and for use with the other equipment to control the equipment/device. Therefore, we understand that the EMC Directive does not apply directly to transistorized inverters. For this reason, we do not place the CE mark on the transistorized inverters. (The CE mark is placed on inverters in accordance with the Low Voltage Directive.) The European power drive manufacturers' organization (CEMEP) also holds this point of view.

### 2) Compliance

We understand that the transistorized inverters are not covered directly by the EMC Directive. However, the EMC Directive applies to machines/equipment into which transistorized inverters have been incorporated, and these machines and equipment must carry the CE marks. Hence, we prepared the European Standard-compliant noise filters and the technical information "EMC Installation Guidelines" (information number BCN-A21041-202) so that machines and equipment incorporating transistorized inverters may conform to the EMC Directive more easily.

### 3) Outline of installation method

Install an inverter using the following methods:

- \* Use the inverter with an European Standard-compliant noise filter.
  - \* For wiring between the inverter and motor, use shielded cables or run them in a metal piping and earth (ground) the cables on the inverter and motor sides with the shortest possible distance.
  - \* Insert a line noise filter and ferrite core into the power and control lines as required.
- Full information including the European Standard-compliant noise filter specifications are written in the technical information "EMC Installation Guidelines" (BCN-A21041-202). Please contact your sales representative.

## (2) Low Voltage Directive

### 1) Our view of transistorized inverters for the Low Voltage Directive

Transistorized inverters are covered by the Low Voltage Directive (Standard to conform to: EN50178).

### 2) Compliance

We have self-confirmed our inverters as products compliant to the Low Voltage Directive and place the CE mark on the inverters.

### 3) Outline of instructions

- \* For the 400V class inverter, the rated input voltage range is three phase 380V to 415V 50Hz/60Hz.
- \* Do not use an earth leakage circuit breaker as an electric shock protector without connecting the equipment to the earth. Connect the equipment to the earth securely.
- \* Wire the earth terminal independently. (Do not connect two or more cables to one terminal.)
- \* Use the cable sizes on page 11 under the following conditions.
  - Ambient temperature: 40°C maximum
  - Wire installation: On wall without ducts or conduitsIf conditions are different from above, select appropriate wire according to EN60204 ANNEX C TABLE 5.
- \* Use the no-fuse breaker and magnetic contactor which conform to the EN or IEC Standard.
- \* Use the breaker of type B (breaker which can detect both AC and DC). If not, provide double or enhanced insulation between the inverter and other equipment, or put a transformer between the main power supply and inverter.
- \* Use the inverter under the conditions of overvoltage category II and contamination level 2 or higher specified in IEC664.
- \* On the input and output of the inverter, use cables of the type and size set forth in EN60204 Appendix C.
- \* The operating capacity of the relay outputs (terminal symbols A, B, C) should be 30VDC, 0.3A.
- \* Control circuit terminals on page 12 are safely isolated from the main circuit.
- \* Environment

	<b>During operation</b>	<b>In storage</b>	<b>During transportation</b>
Ambient Temperature	-10°C to +50°C	-20°C to +65°C	-20°C to +65°C
Ambient Humidity	90% RH or less	90% RH or less	90% RH or less
Maximum Altitude	1,000m	1,000m	10,000m

Details are given in the technical information "Low Voltage Directive Conformance Guide" (BCN-A21041-203). Please contact your sales representative.

## Appendix 2 Instructions for UL and cUL

(Standard to comply with: UL 508C, CSA C22.2 No.14)



### 1. Installation

The S500E is UL-listed as a product for use in an enclosure.

Design the enclosure so that the ambient temperature, humidity and ambience of the inverter will satisfy the above specifications. (Refer to page 72)

#### **Branch circuit protection**

For installation in the United States, branch circuit protection must be provided in accordance with the National Electrical Code and any applicable local codes.

For installation in Canada, branch circuit protection must be provided in accordance with the Canada Electrical Code and any applicable provincial codes.

### 2. Wiring of the power supply and motor

For wiring the input (R, S, T) and output (U, V, W) terminals of the inverter, use the UL-listed copper wires (rated at 75°C) and round crimping terminals. Crimp the crimping terminals with the crimping tool recommended by the terminal maker.

### 3. Short circuit ratings

Suitable For Use in A Circuit Capable Of Delivering Not More Than 5kA rms Symmetrical Amperes.

## 4. Motor overload protection

These inverters provide solid state motor overload protection.

Set Pr. 9 using the following instructions,  
(Pr. 9 "electronic thermal O/L relay").

### <Setting>

- Set the rated current [A] of the motor in Pr. 9.
- Setting "0" in Pr. 9 disables electronic thermal relay function (motor protective function). (The protective function of the inverter is activated.)
- When using a Mitsubishi constant-torque motor, first set "1" in Pr. 71 "applied motor". (This provides a 100% continuous torque characteristic in the low-speed range.) Then, set the rated current of the motor in Pr. 9 "electronic thermal O/L relay".

### CAUTION

- When two or more motors are connected to the inverter, they cannot be protected by the electronic thermal relay function. Install an external thermal relay to each motor.
- When a difference between the inverter and motor capacities is large and the setting becomes less than half amount of the inverter rated current, the protective characteristics of the electronic thermal relay function will be deteriorated. In this case, use an external thermal relay.
- A special motor cannot be protected by the electronic thermal relay function. Use an external thermal relay.

### Reference: Motor overload protection characteristics

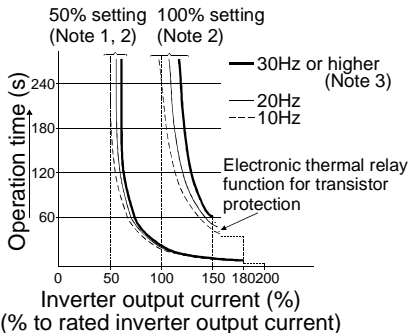

- Protection activating range  
Range on the right of characteristic curve
- Normal operating range  
Range on the left of characteristic curve

(Note 1) When you set the 50% value (current value) of the rated inverter output current.

(Note 2) The % value denotes the percentage of the current value to the rated inverter output current, not to the rated motor current.

(Note 3) This characteristic curve will be described even under operation of 6Hz or higher when you set the electronic thermal relay function dedicated to the Mitsubishi constant-torque motor.

REVISIONS

\* The manual number is given on the bottom left of the back cover.

Print Date	*Manual Number	Revision
May, 2003	IB(NA)-0600151E-A	First edition
Aug., 2004	IB(NA)-0600151E-B	<div style="border: 1px solid black; display: inline-block; padding: 2px;">Addition</div> Three-phase 400V power input specification, single-phase 200V power input specification, single-phase 100V power input specification

 **For Maximum Safety**

- Mitsubishi transistorized inverters are not designed or manufactured to be used in equipment or systems in situations that can affect or endanger human life.
- When considering this product for operation in special applications such as machinery or systems used in passenger transportation, medical, aerospace, atomic power, electric power, or submarine repeating applications, please contact your nearest Mitsubishi sales representative.
- Although this product was manufactured under conditions of strict quality control, you are strongly advised to install safety devices to prevent serious accidents when it is used in facilities where breakdowns of the product are likely to cause a serious accident.
- Please do not use this product for loads other than three-phase induction motors.